

Arrangement rectangulaire de points

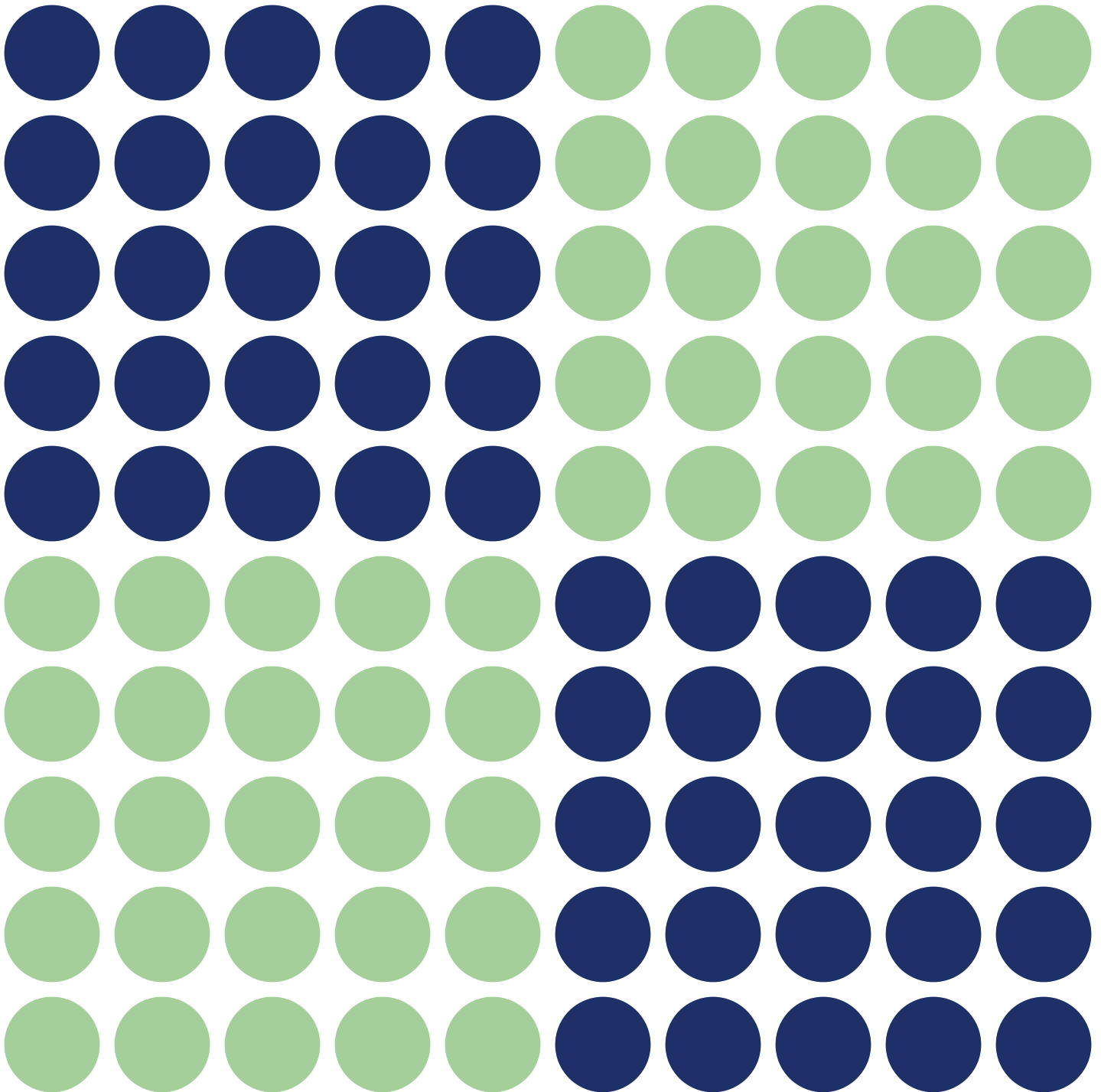

Balance

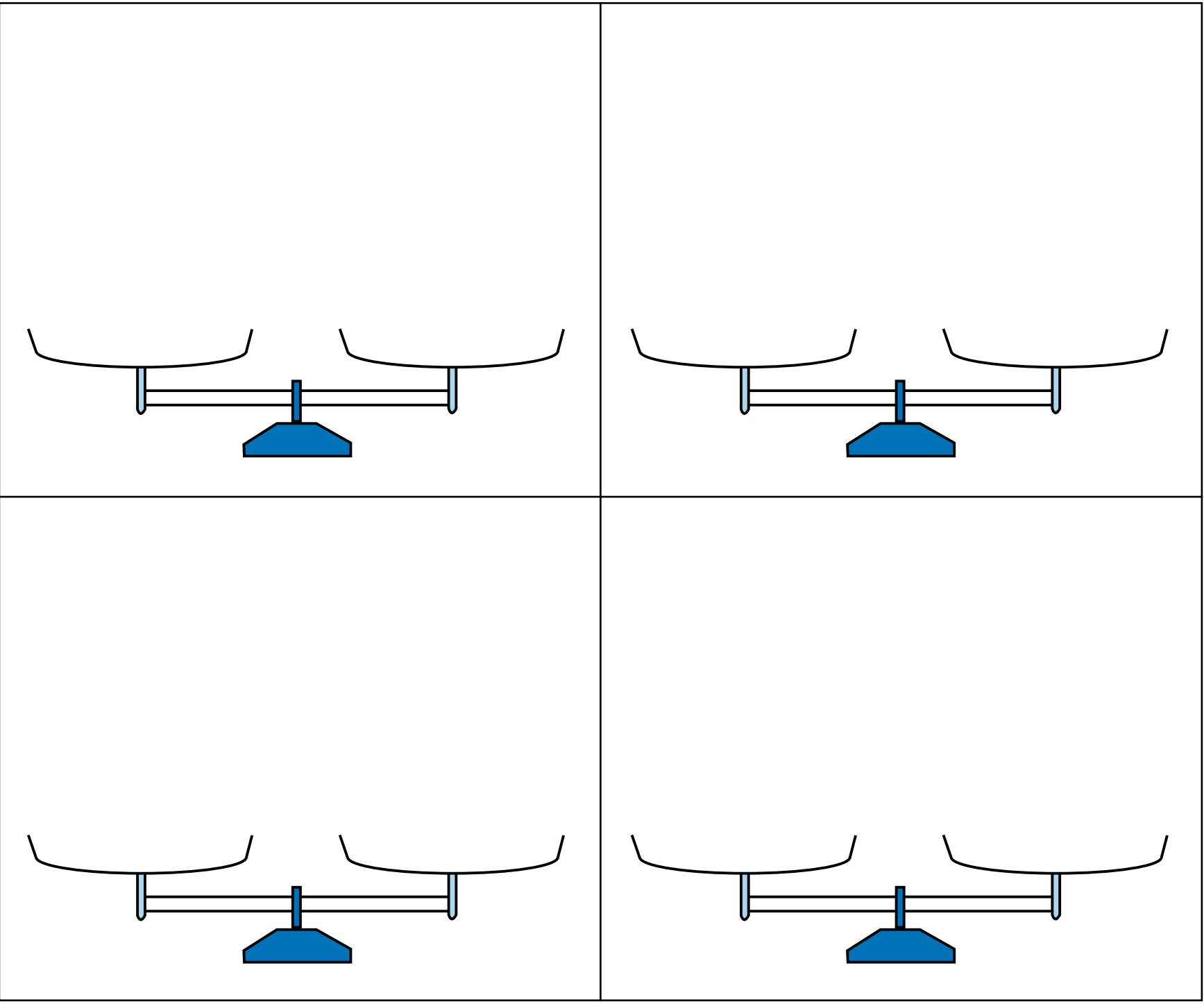

Balance

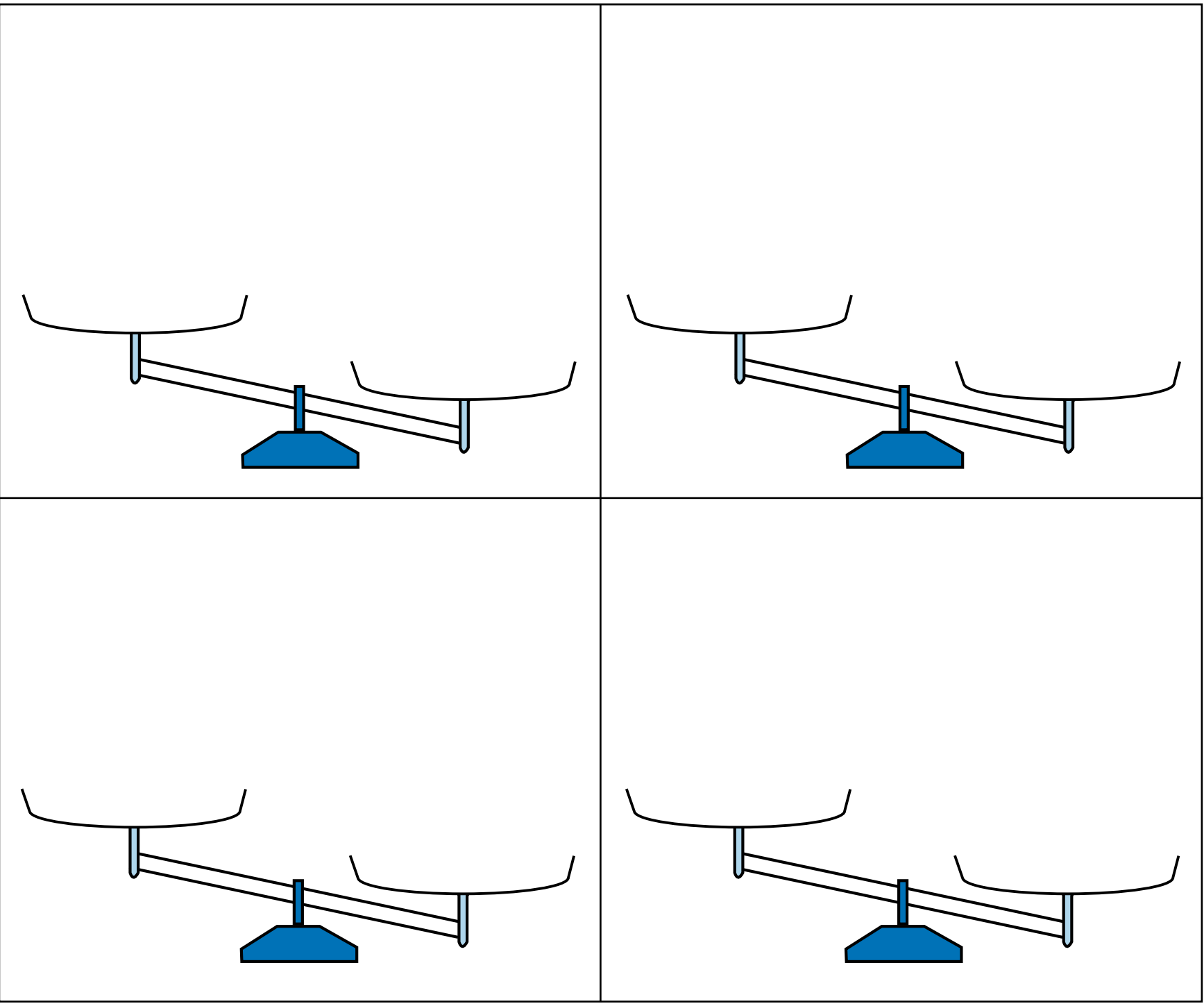

Balance

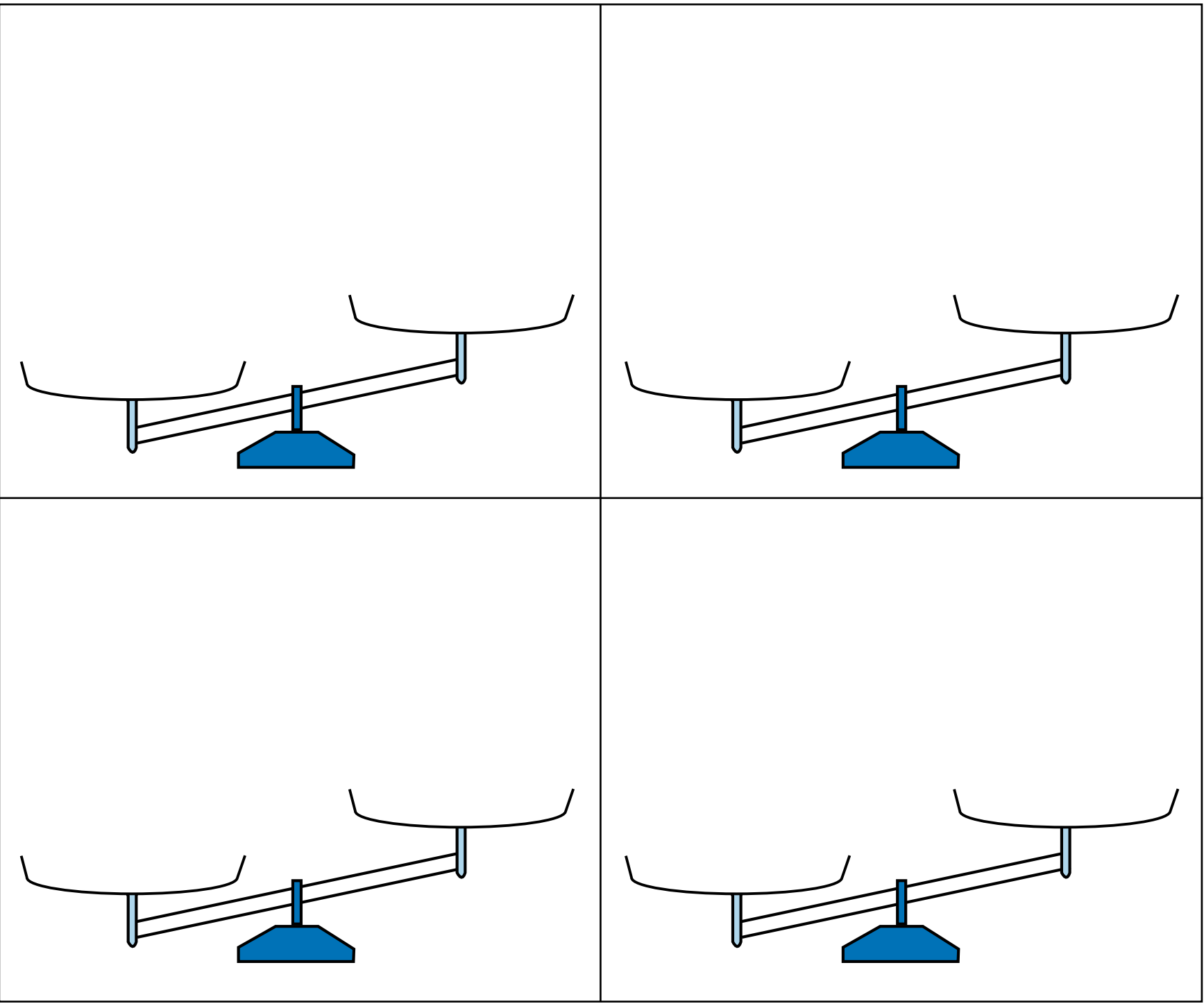



Bande numérique de 1 à 20

1	2	3	4	5	6	7	8	9	10	11	12	13	14	15	16	17	18	19	20
---	---	---	---	---	---	---	---	---	----	----	----	----	----	----	----	----	----	----	----

Table des matières

Bande numérique vide

--	--	--	--	--	--	--	--	--	--	--	--	--	--	--	--	--	--	--	--



Bande numérique de 1 à 20

1	2	3	4	5	6	7	8	9	10	11	12	13	14	15	16	17	18	19	20
---	---	---	---	---	---	---	---	---	----	----	----	----	----	----	----	----	----	----	----

Bande numérique vide

--	--	--	--	--	--	--	--	--	--	--	--	--	--	--	--	--	--	--	--



Bande numérique de 1 à 20

1	2	3	4	5	6	7	8	9	10	11	12	13	14	15	16	17	18	19	20
---	---	---	---	---	---	---	---	---	----	----	----	----	----	----	----	----	----	----	----

Bande numérique vide

--	--	--	--	--	--	--	--	--	--	--	--	--	--	--	--	--	--	--	--

Liste FR

Blocs de base dix - représentation imagée

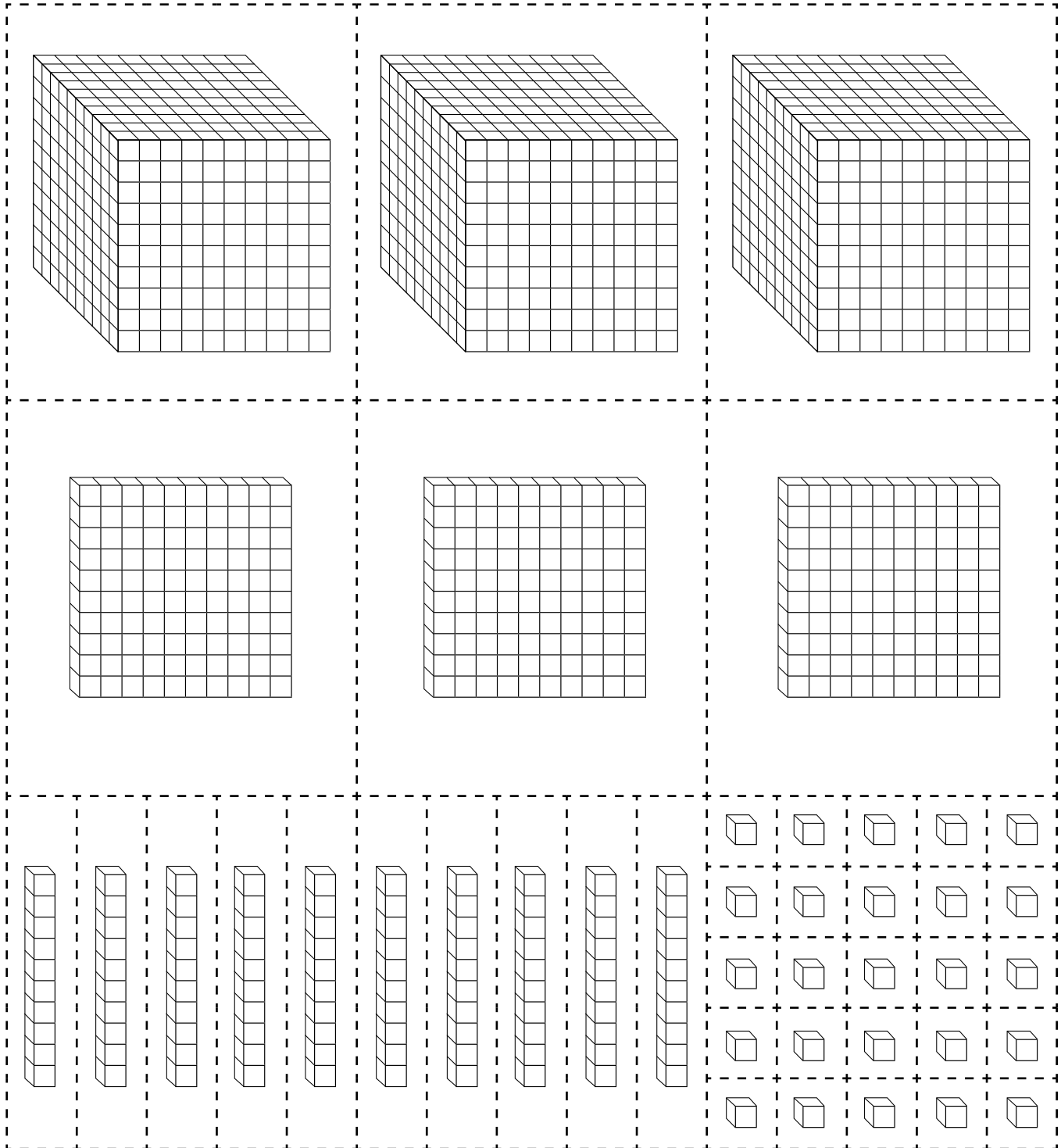

Cartes à 5 points - Petit format

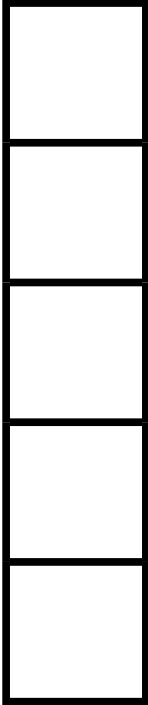
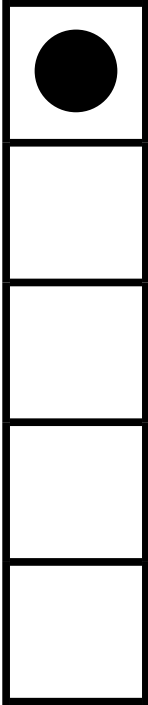
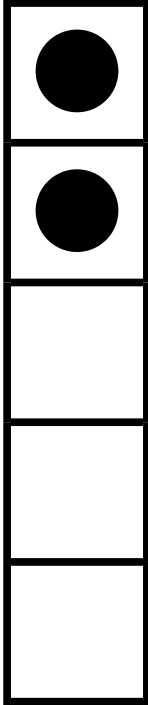
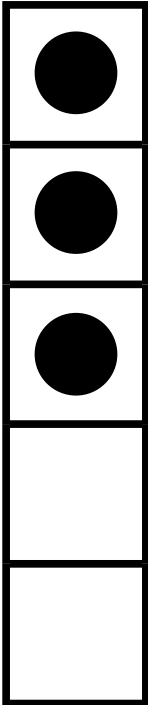
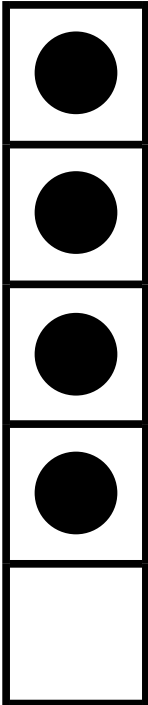
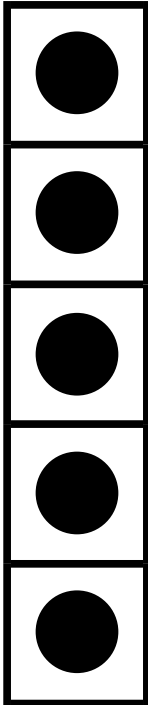



Cartes à 5 points - Grand format

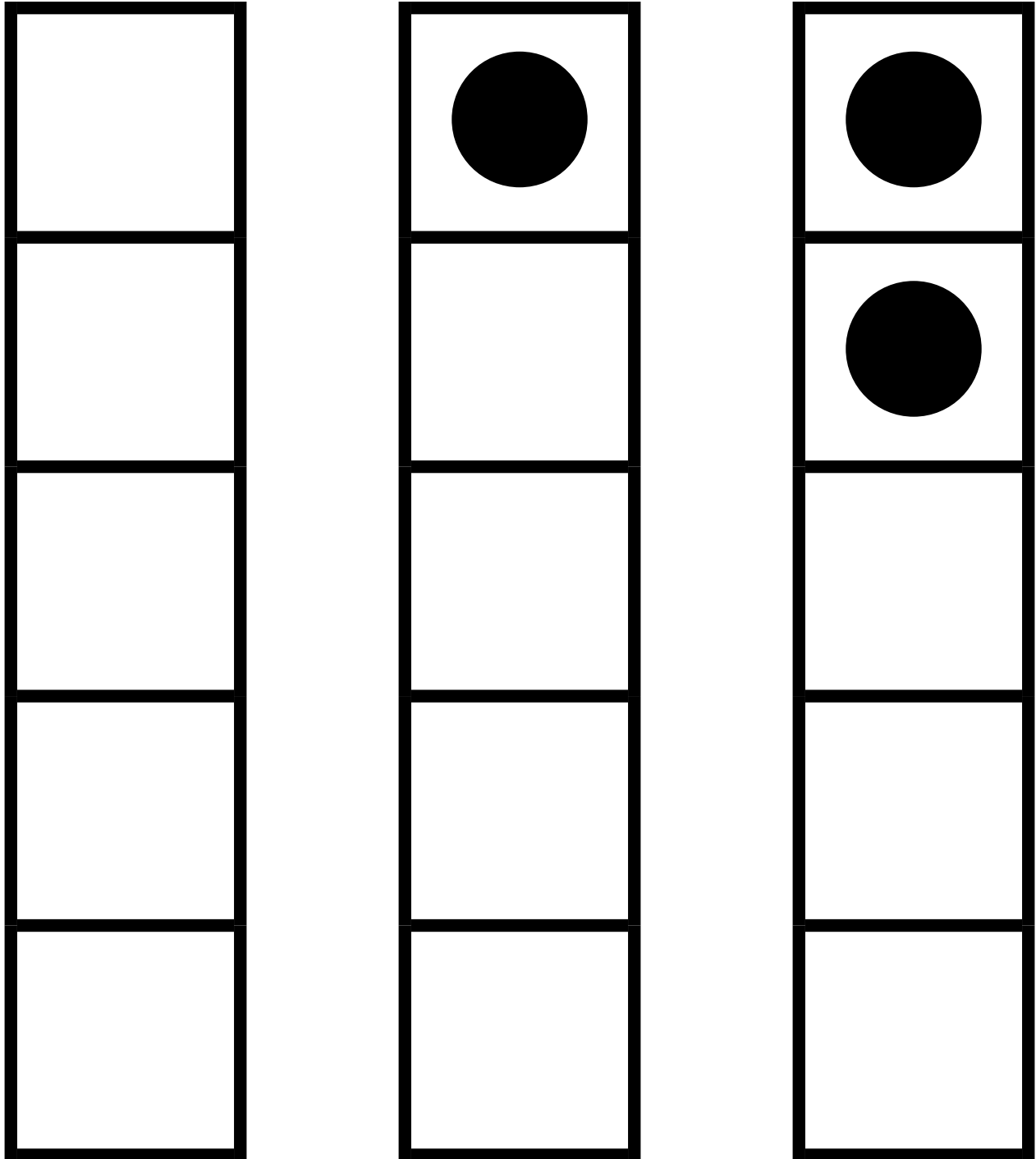

Cartes à 5 points - Grand format (suite)

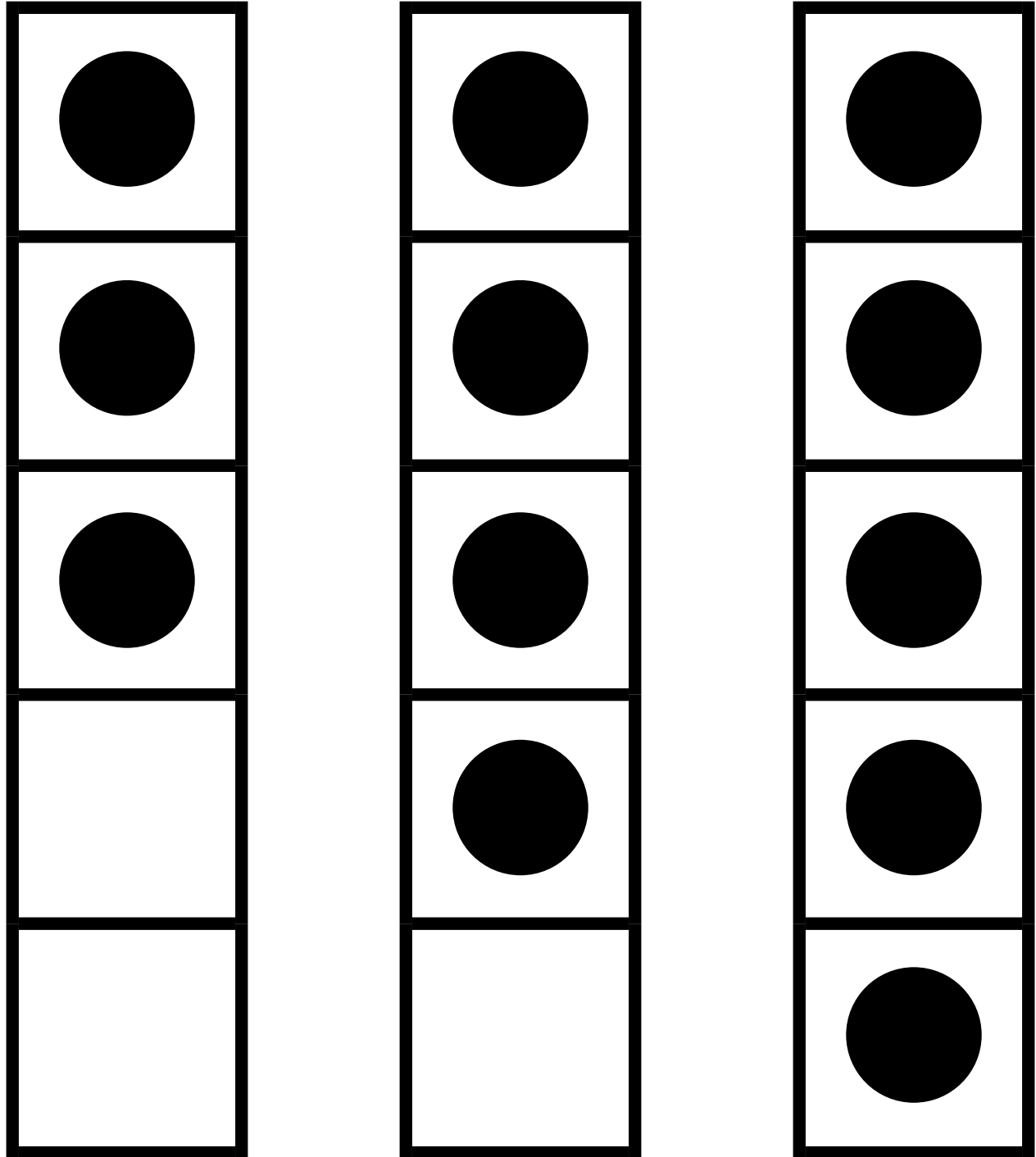

Cartes à 10 points - représentation imagée Simple - Petit format

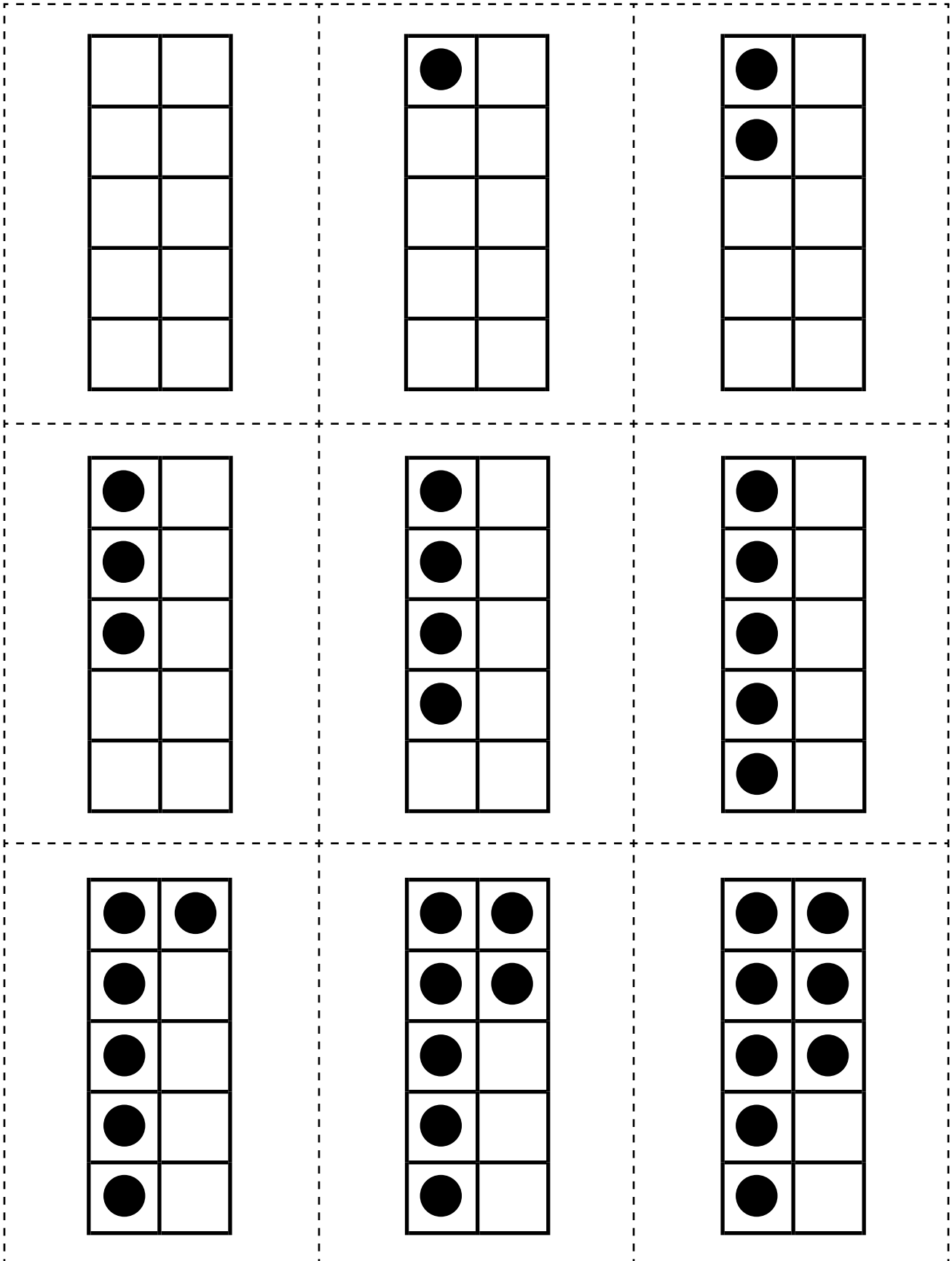

Cartes à 10 points – représentation imagée Simple - Petit format (suite)

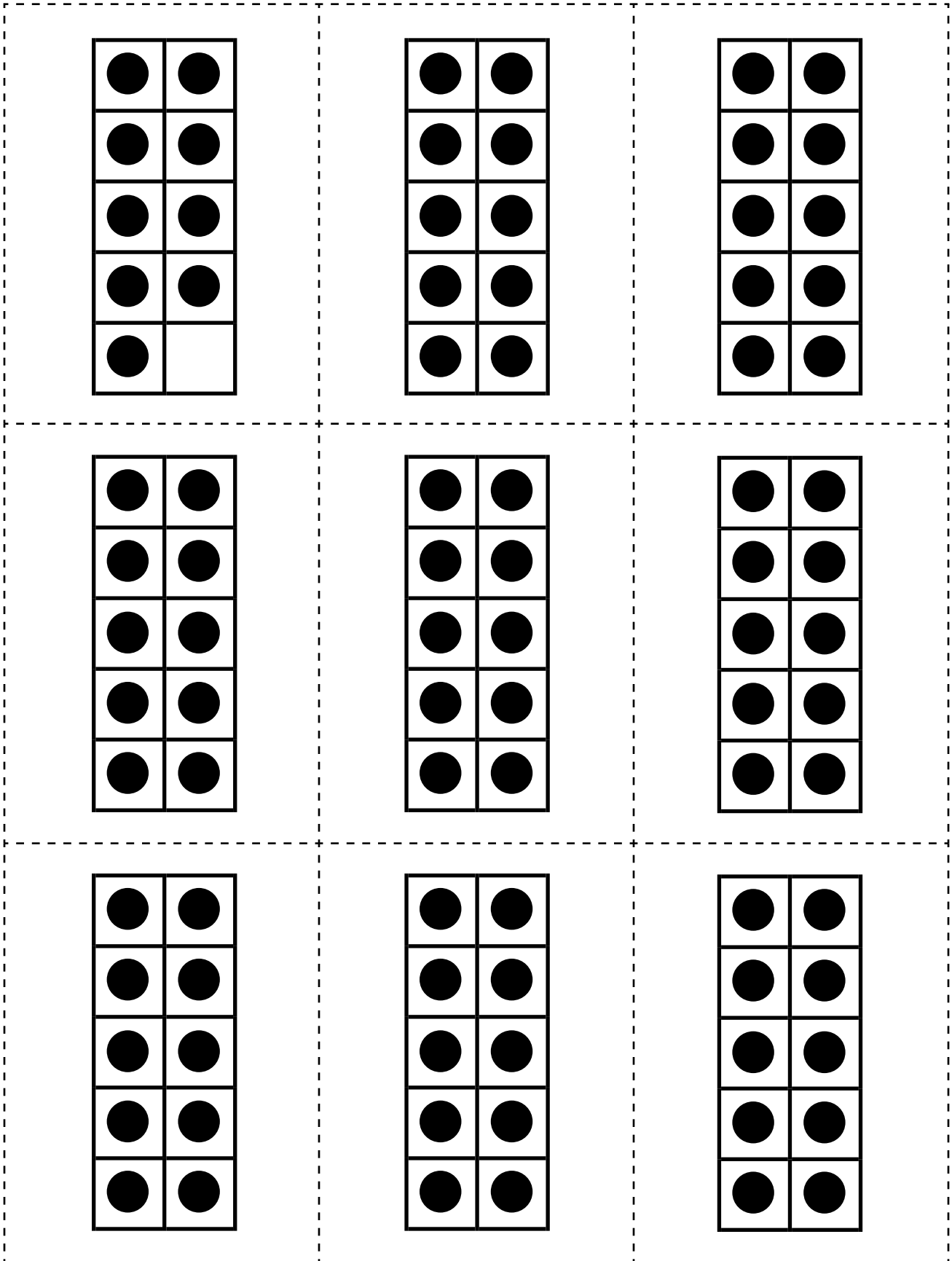

Cartes à 10 points - représentation imagée Simple - Grand format

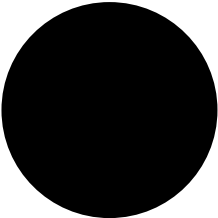





Cartes à 10 points - représentation imagée

Simple - Grand format (suite)

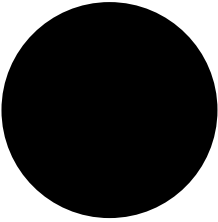
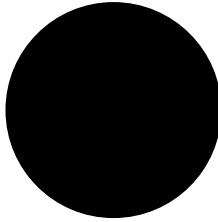
Cartes à 10 points - représentation imagée

Simple - Grand format (suite)

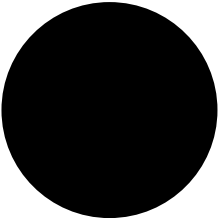
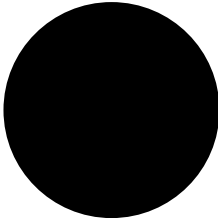
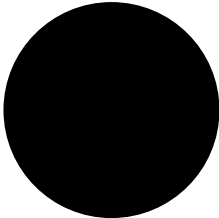

Cartes à 10 points - représentation imagée

Simple - Grand format (suite)

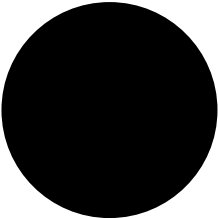
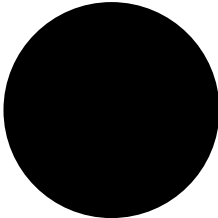
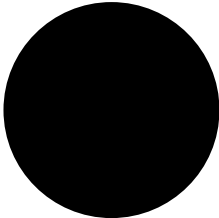
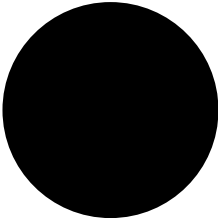

Cartes à 10 points - représentation imagée

Simple - Grand format (suite)

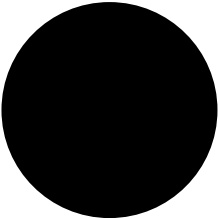
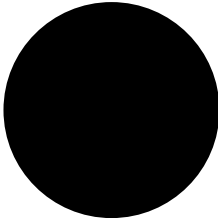
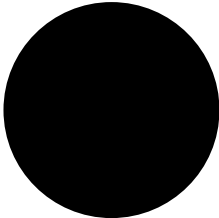
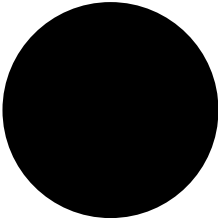
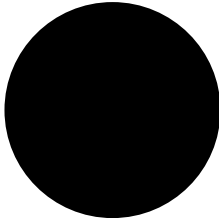

Cartes à 10 points - représentation imagée

Simple - Grand format (suite)

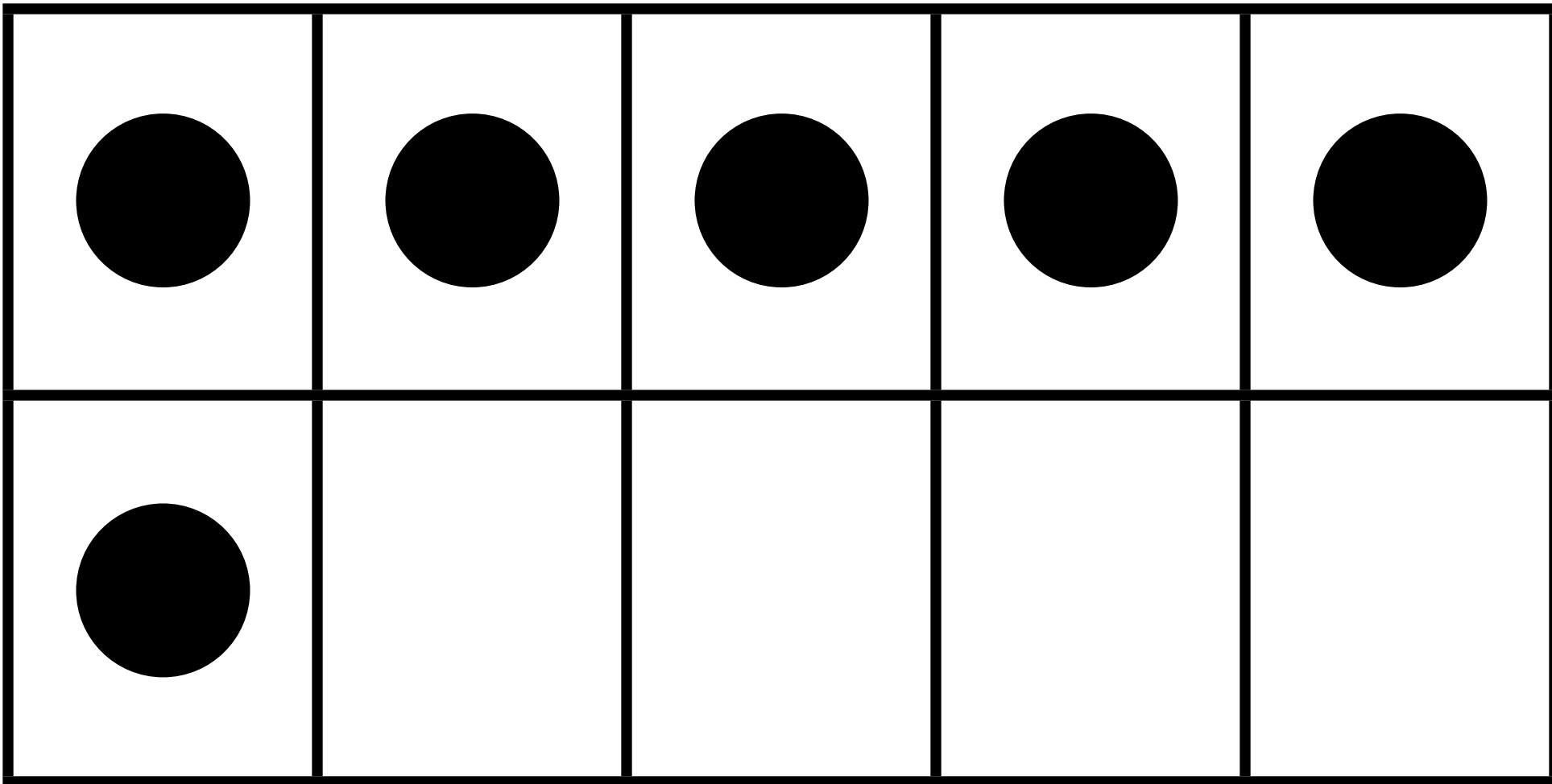

Cartes à 10 points - représentation imagée

Simple - Grand format (suite)

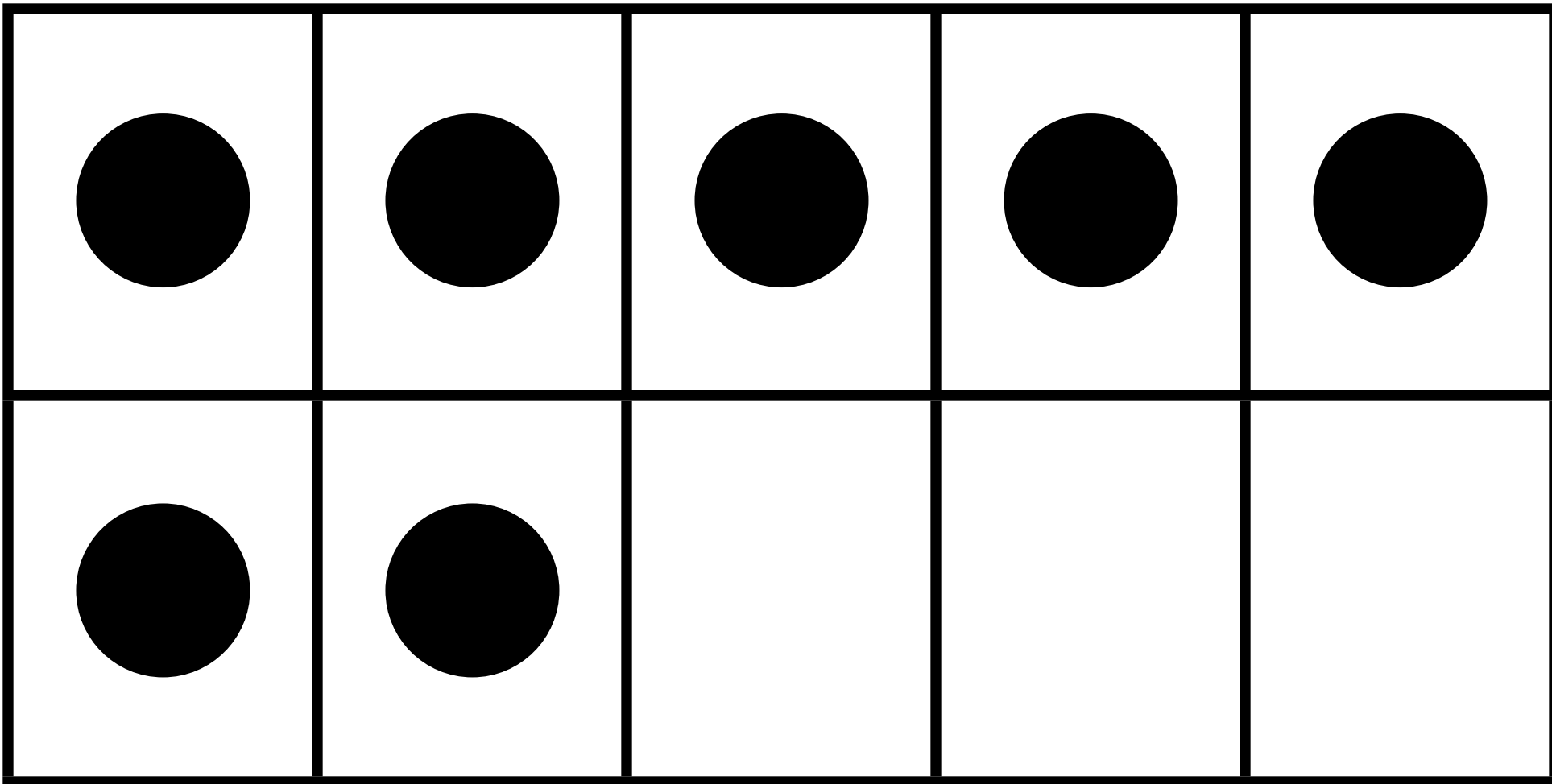

Cartes à 10 points - représentation imagée

Simple - Grand format (suite)

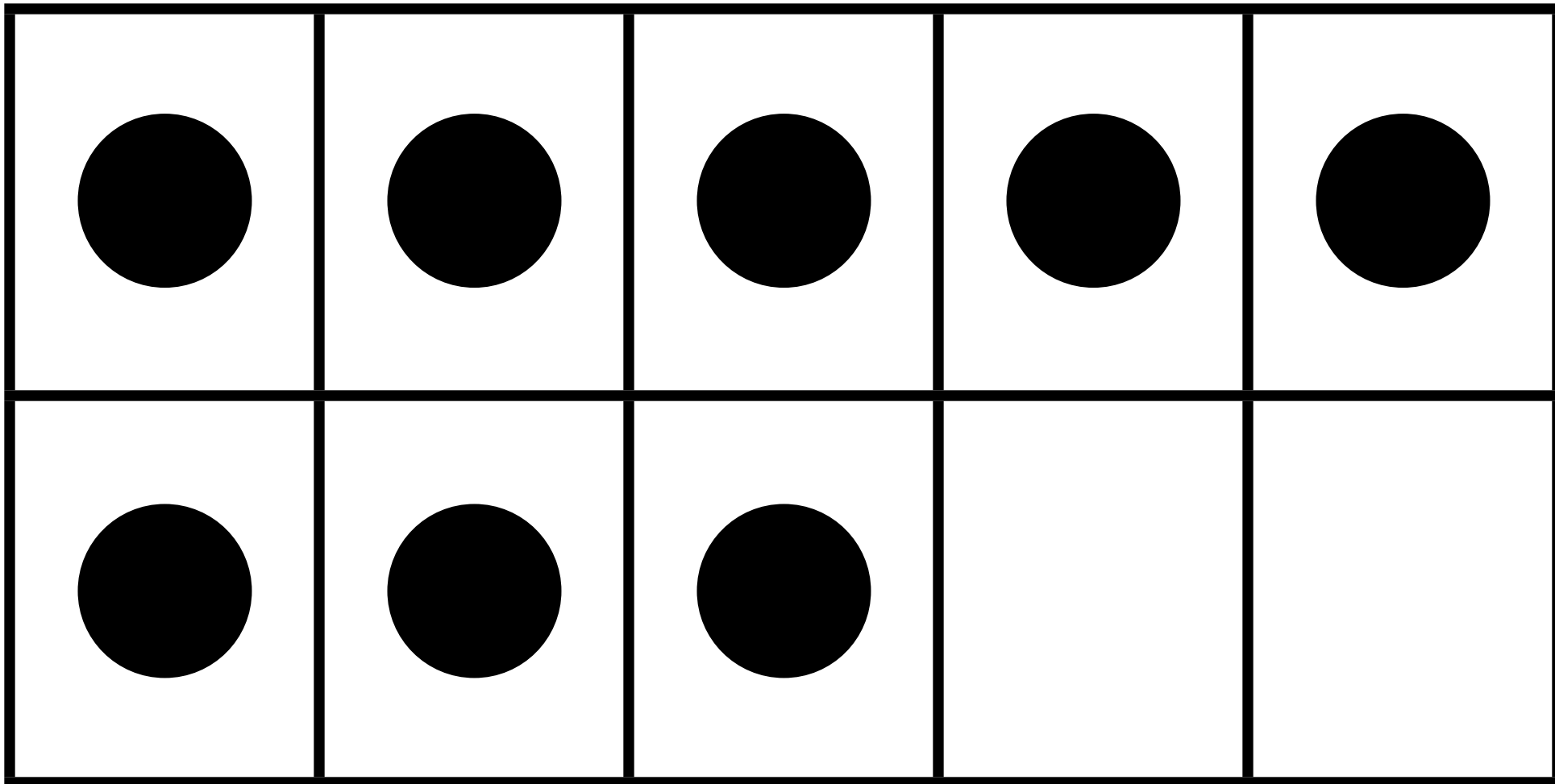

Cartes à 10 points - représentation imagée

Simple - Grand format (suite)

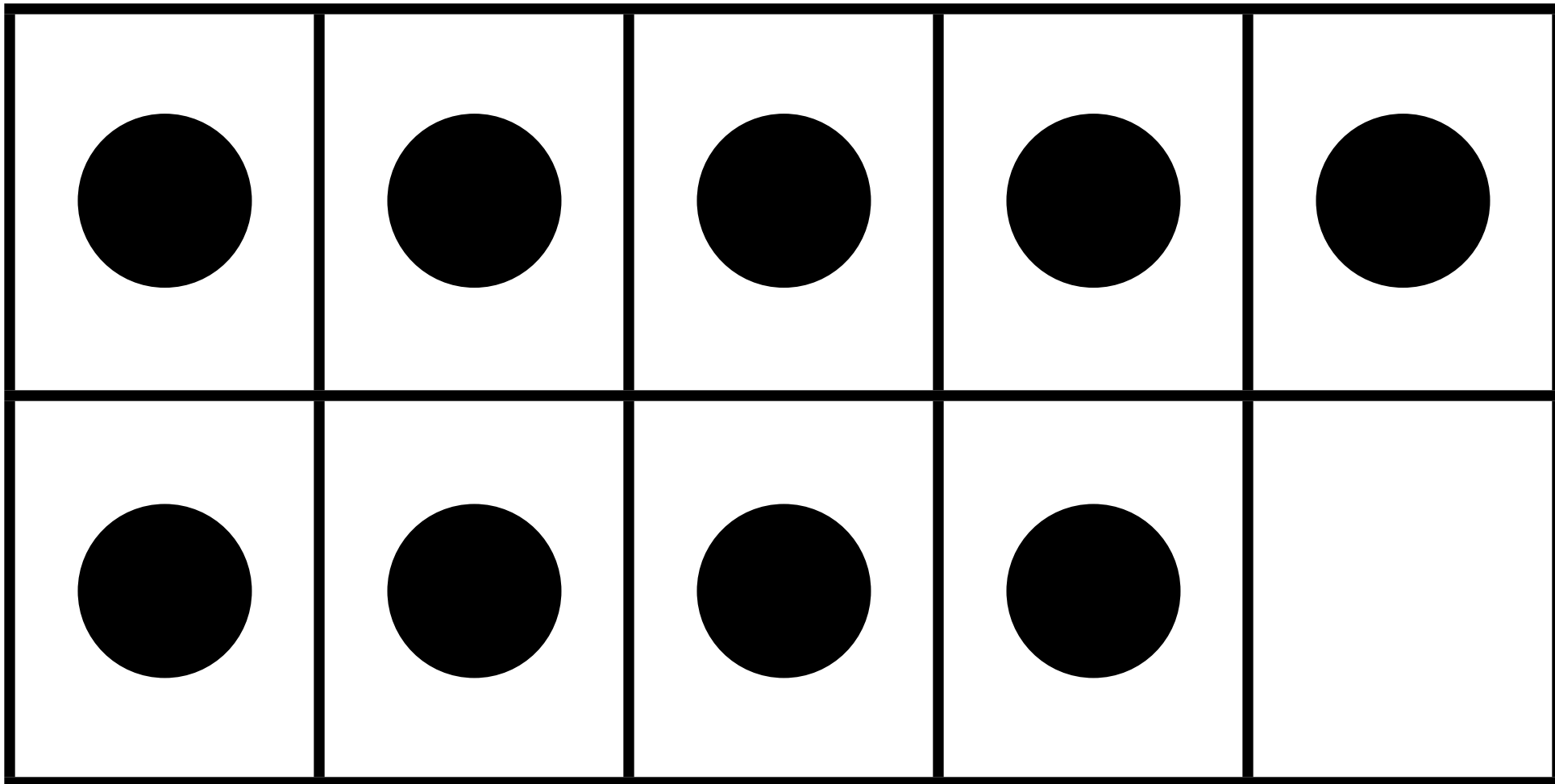

Cartes à 10 points - représentation imagée

Simple - Grand format (suite)

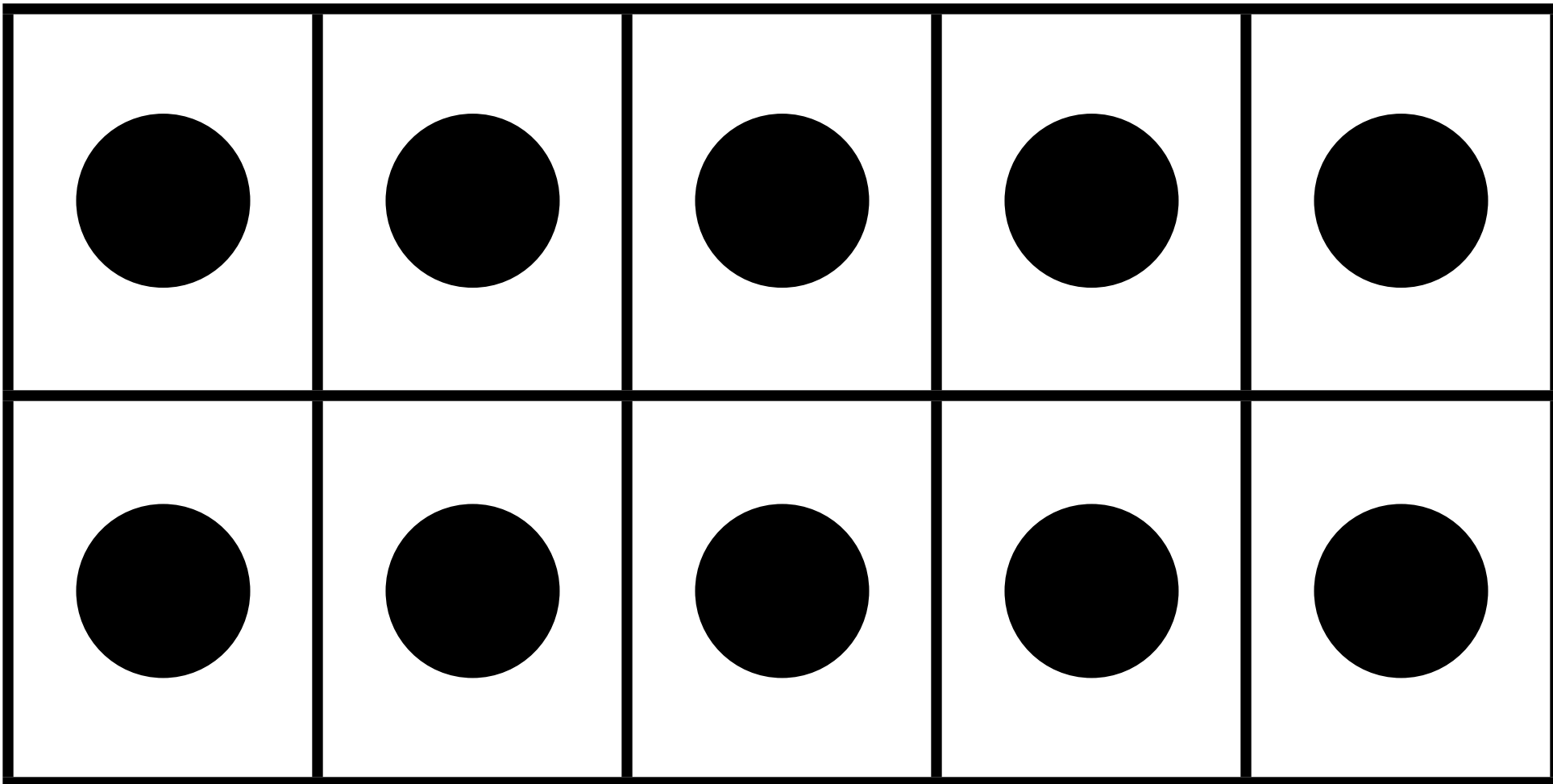

Cartes à 10 points - représentation imagée

Double - Petit format



Cartes à 10 points – représentation imagée

Double - Petit format (suite)

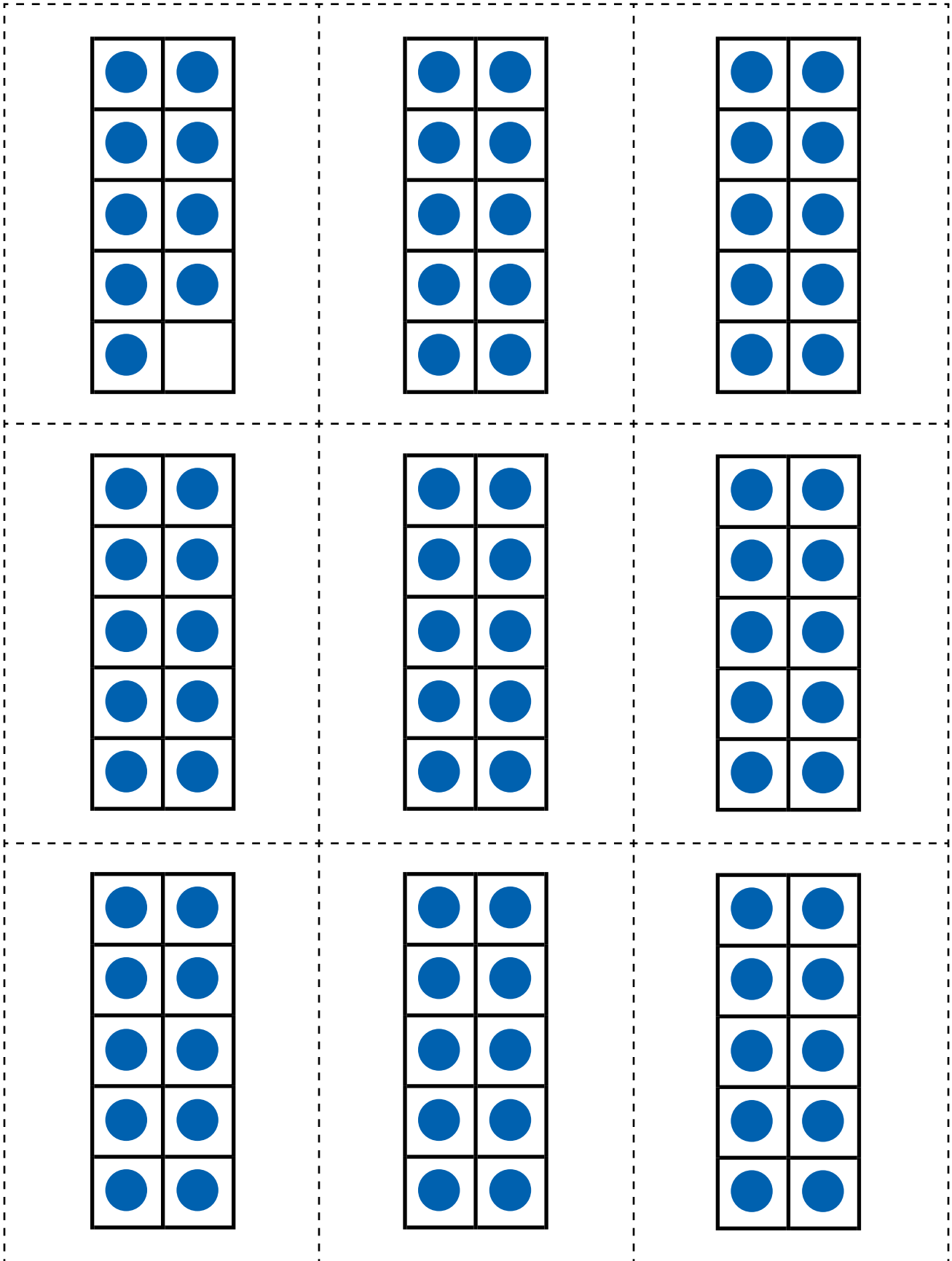

Cartes à 10 points - représentation imagée

Double - Grand format

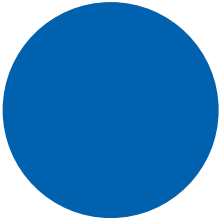

Cartes à 10 points - représentation imagée

Double - Grand format (suite)

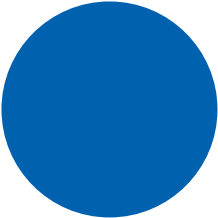

Cartes à 10 points - représentation imagée

Double - Grand format (suite)

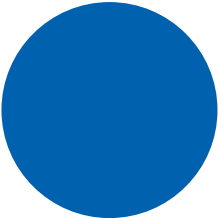
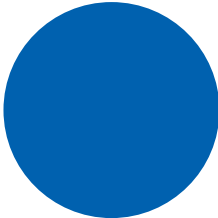
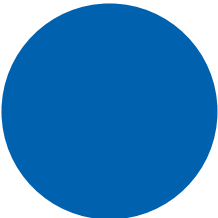

Cartes à 10 points - représentation imagée

Double - Grand format (suite)

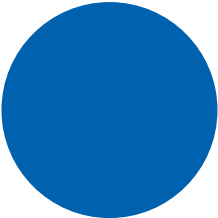
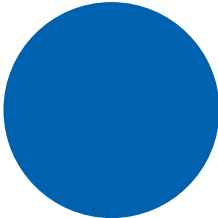
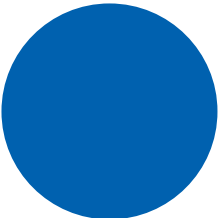
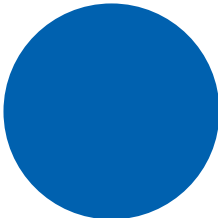

Cartes à 10 points - représentation imagée

Double - Grand format (suite)

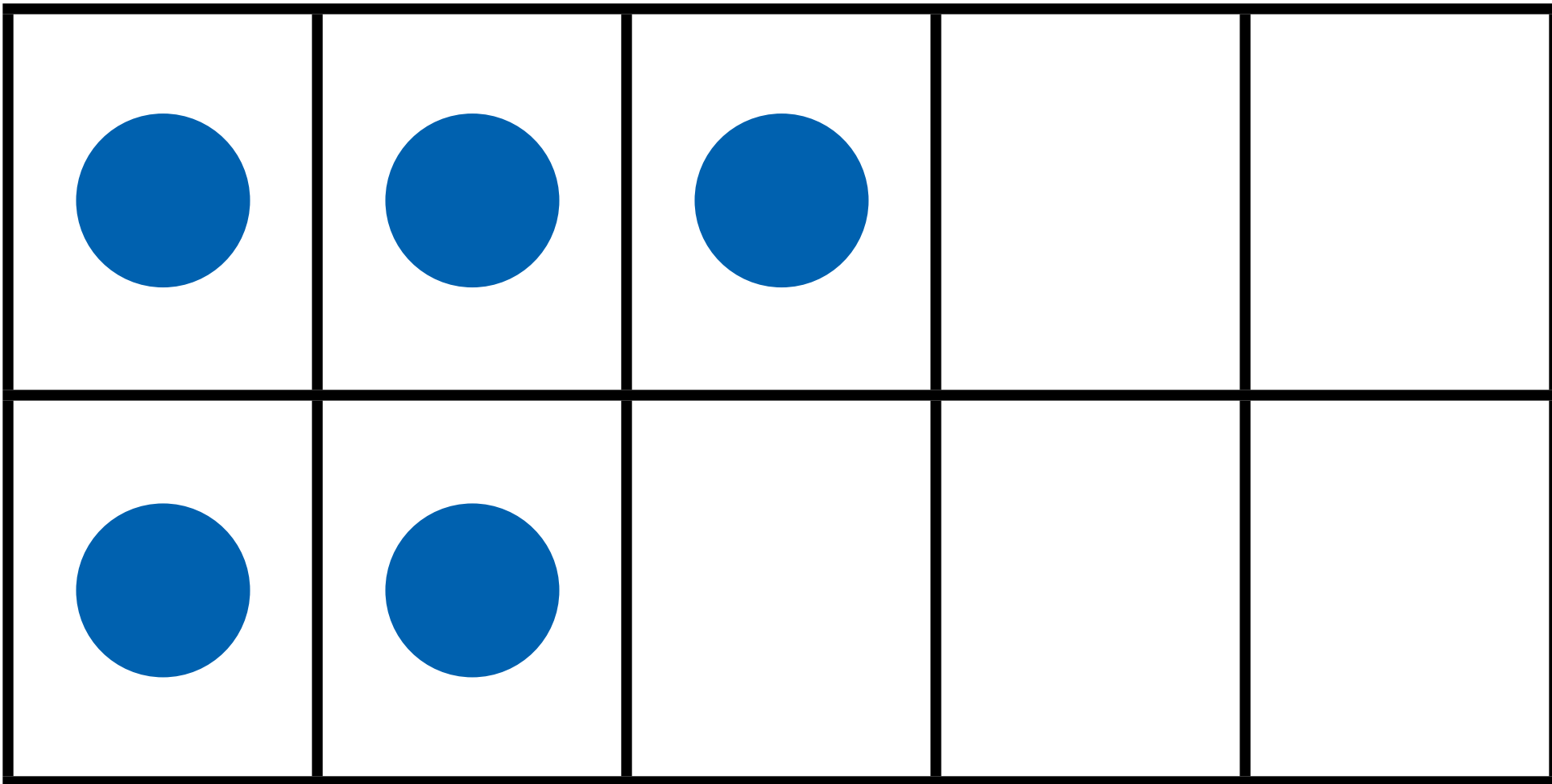

Cartes à 10 points - représentation imagée

Double - Grand format (suite)

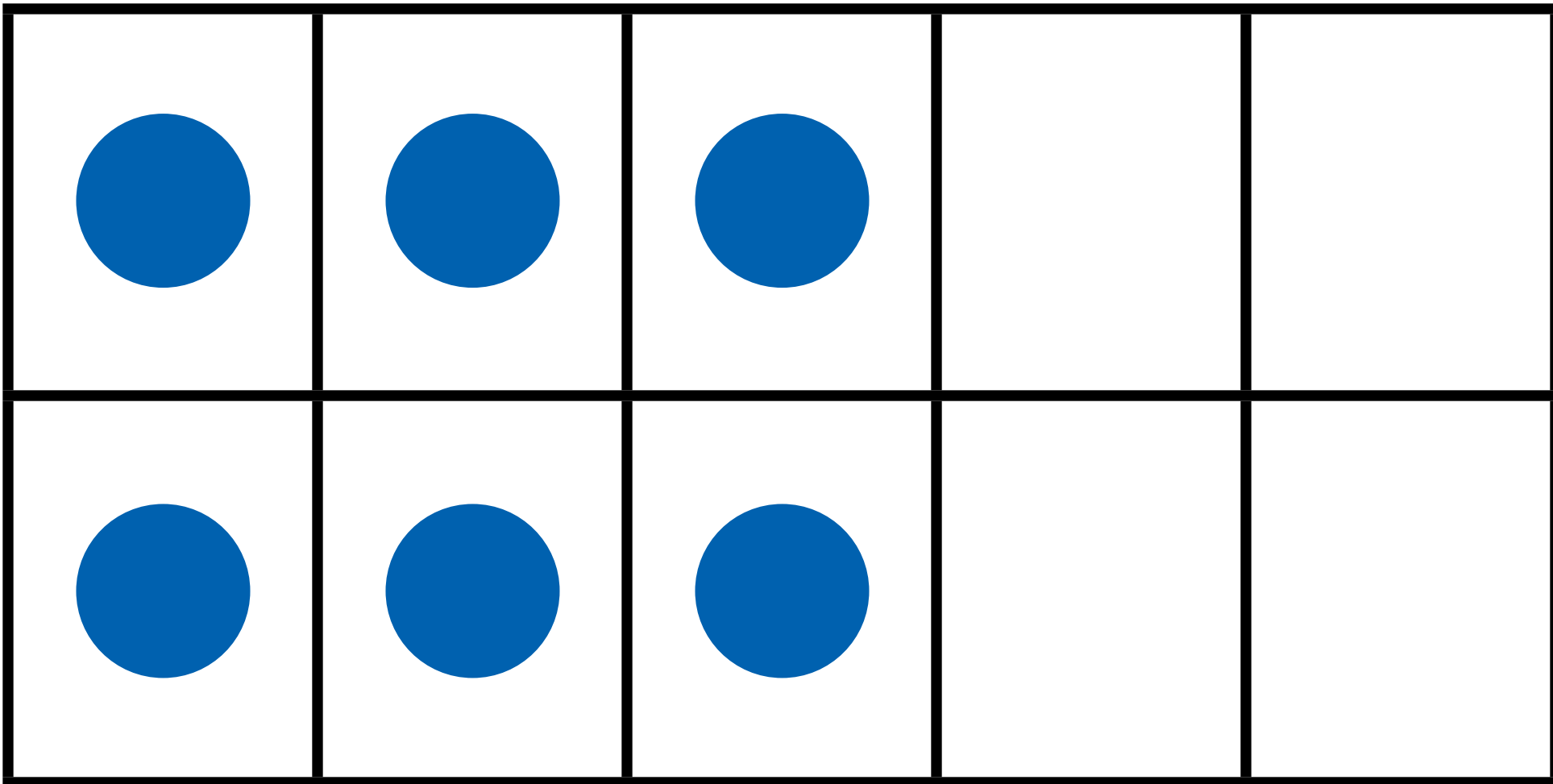

Cartes à 10 points - représentation imagée

Double - Grand format (suite)

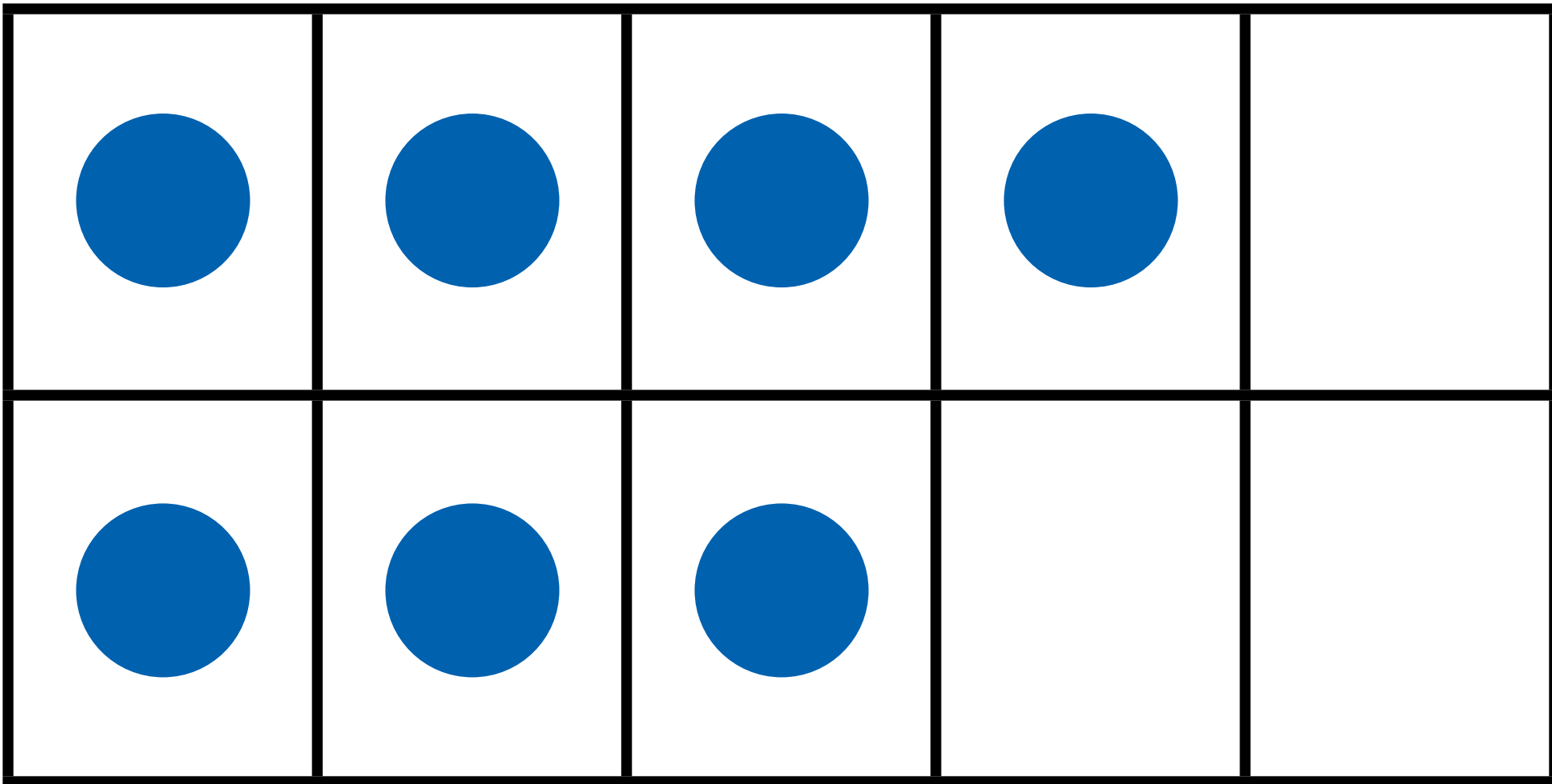

Cartes à 10 points - représentation imagée

Double - Grand format (suite)

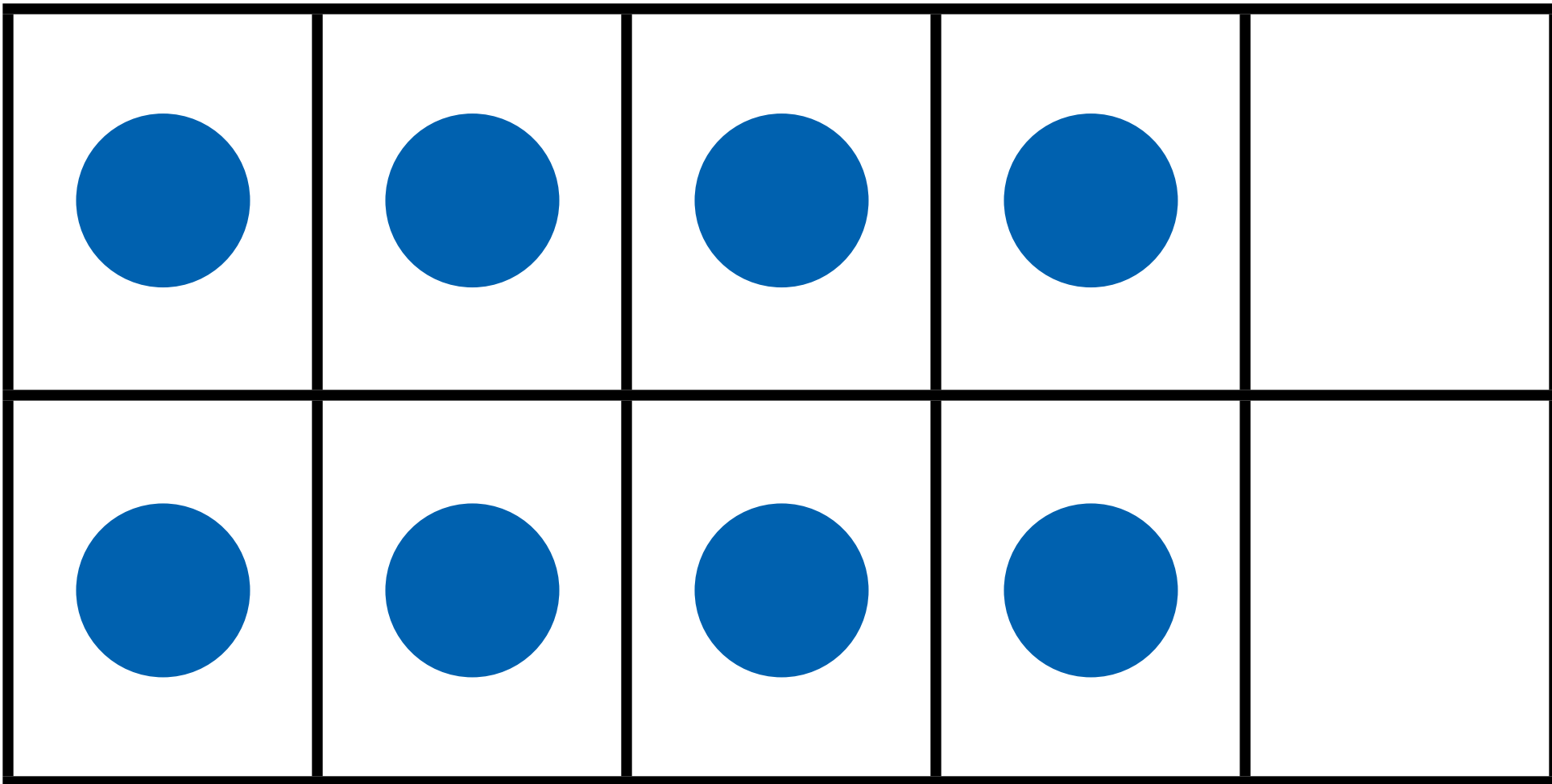

Cartes à 10 points - représentation imagée

Double - Grand format (suite)

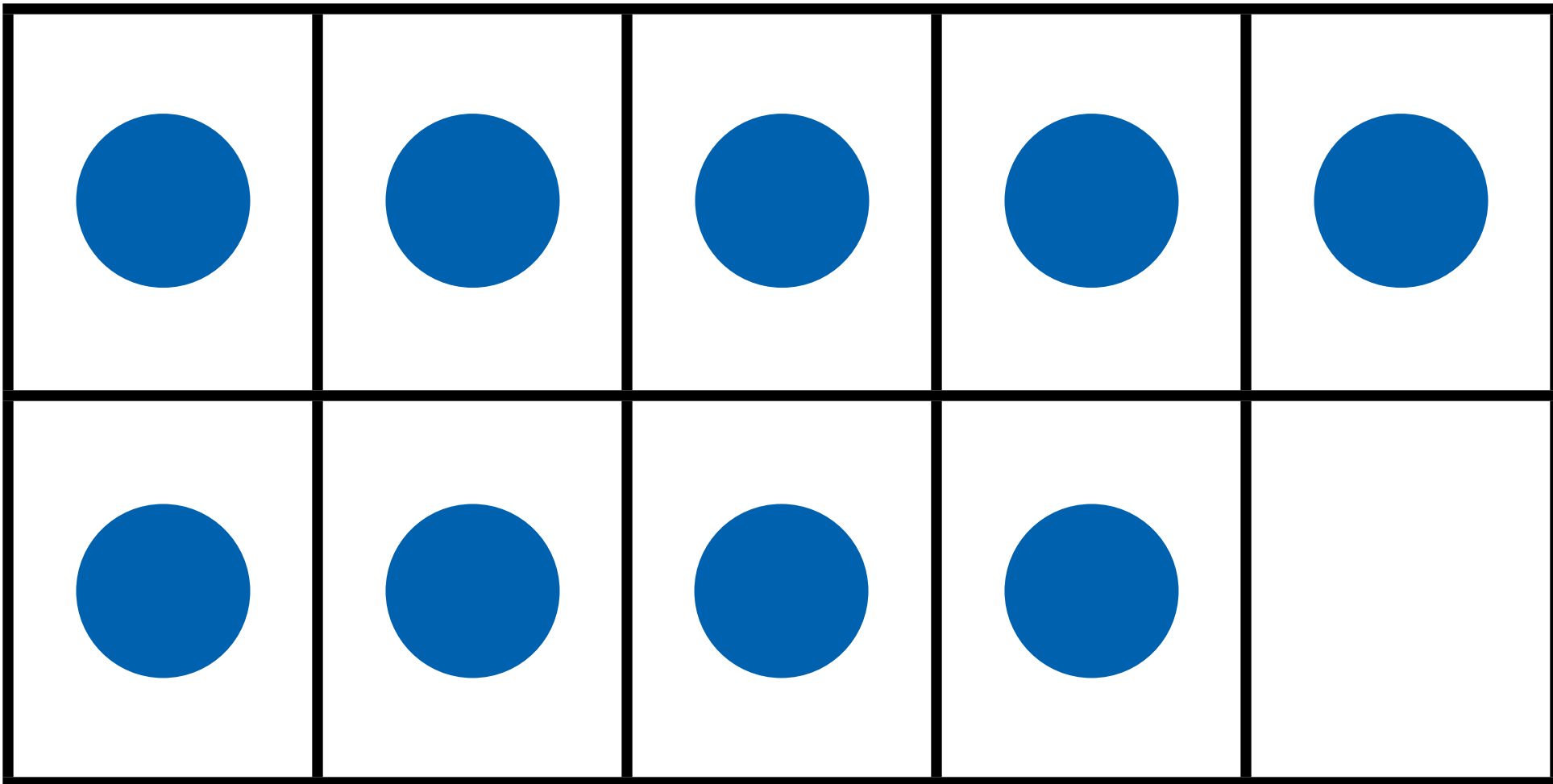

Cartes à 10 points - représentation imagée

Double - Grand format (suite)

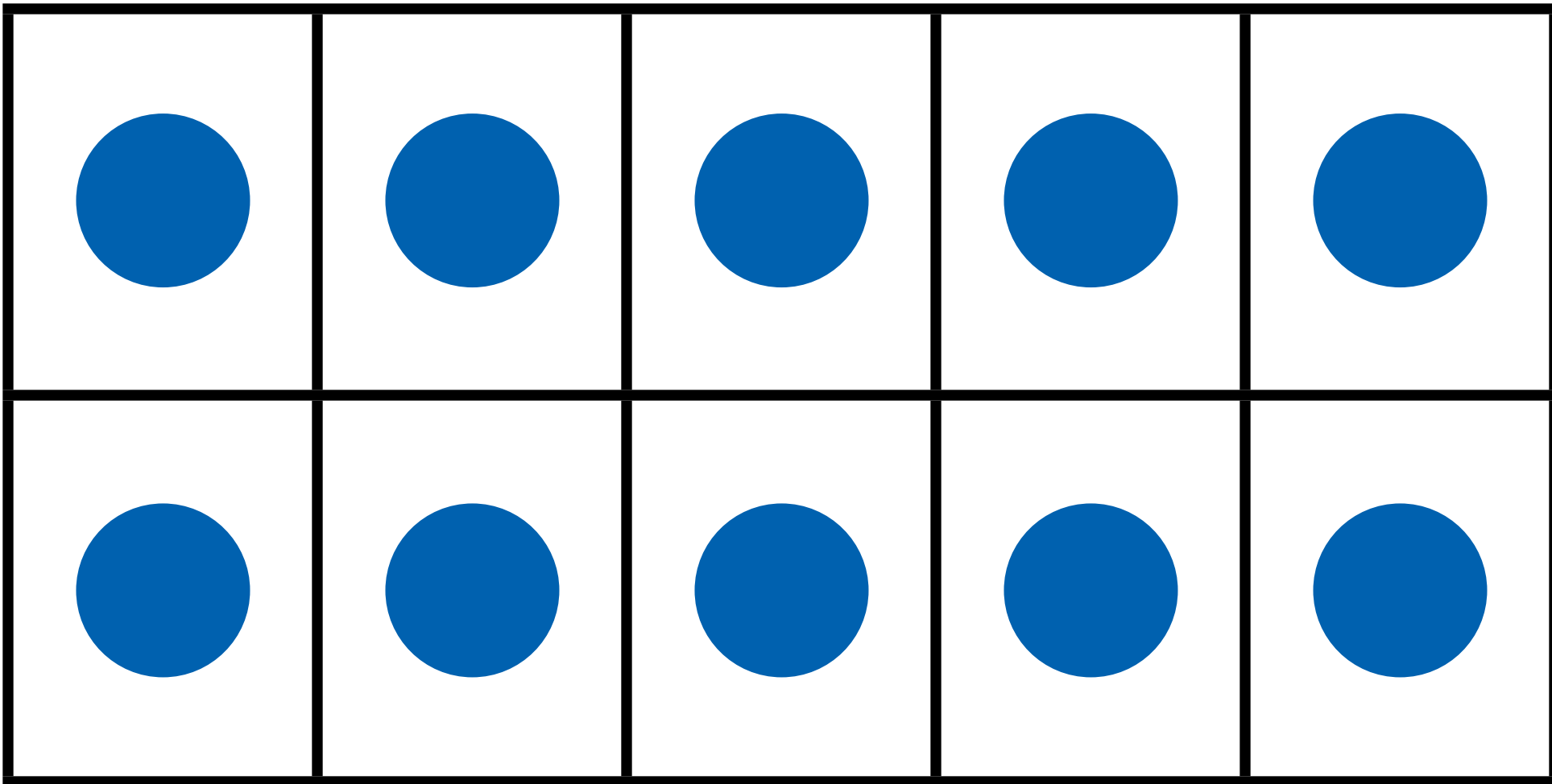





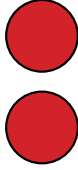
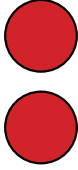

Carte à 10 points vide (Horizontal)

Carte à 10 points - Vide (Vertical)

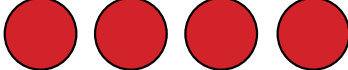

Cartes de la partie manquante

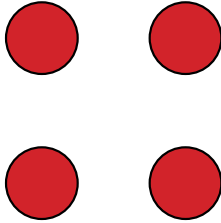



5

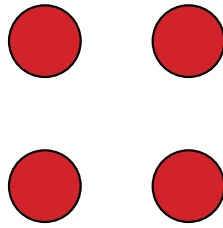

5

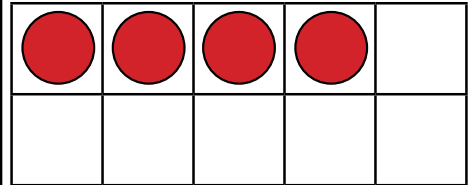

5

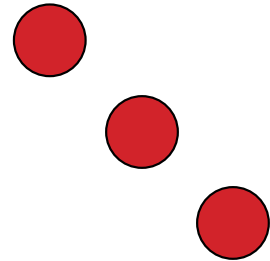
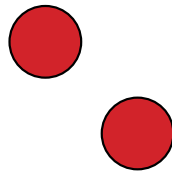

5

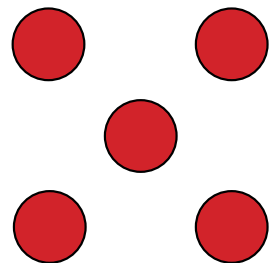

5

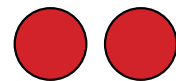
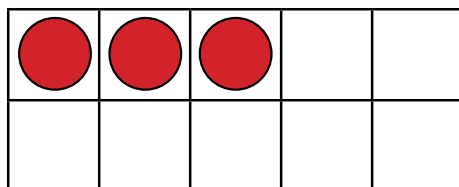



6

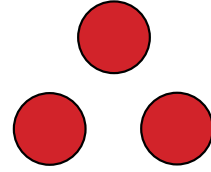
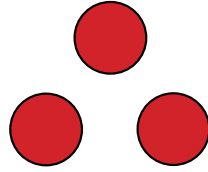

6

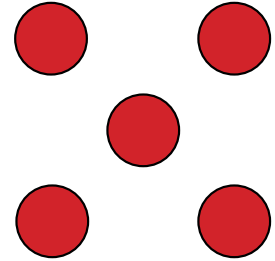

6

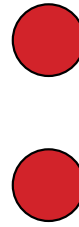
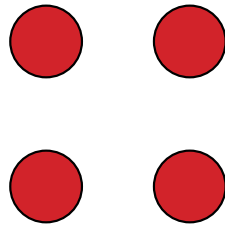

6

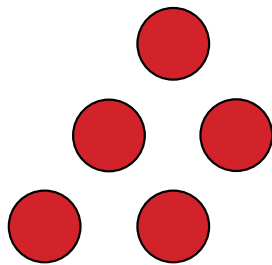

6

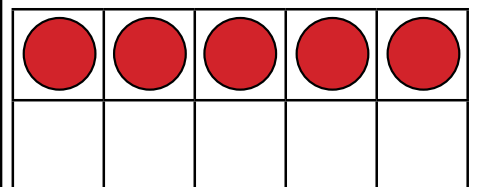



7

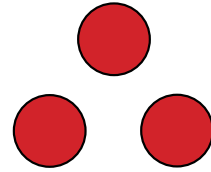
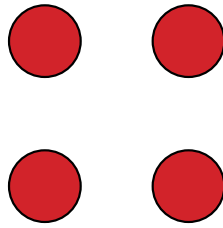

7

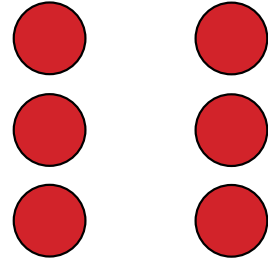

7

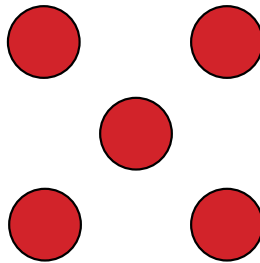

7

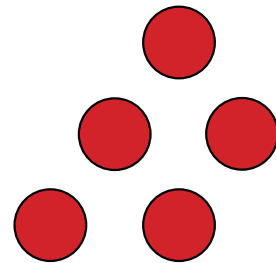
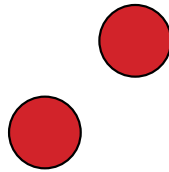

7

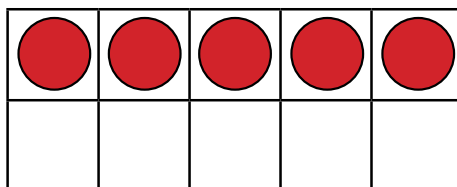

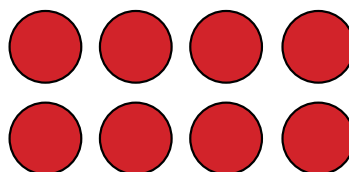
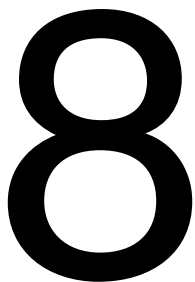
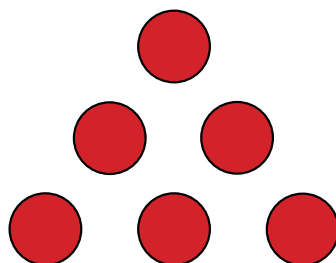
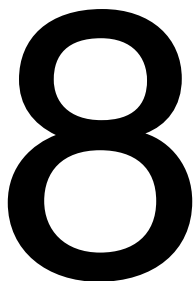
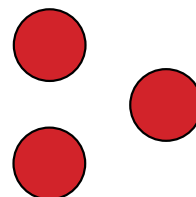
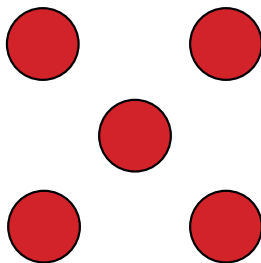
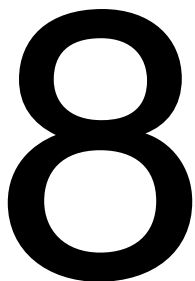
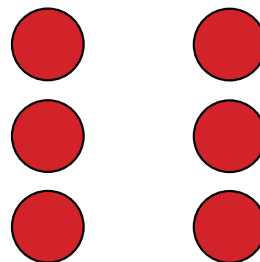
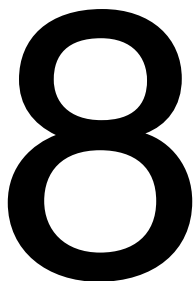
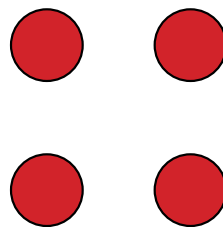
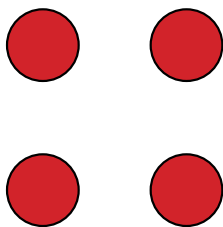
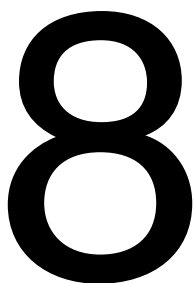



9

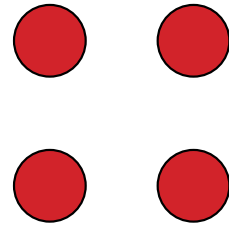
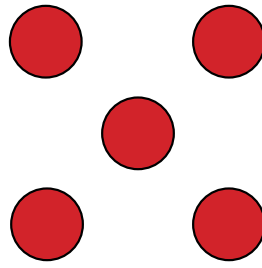

9

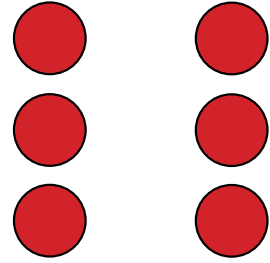
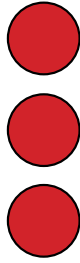

9

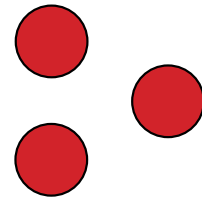
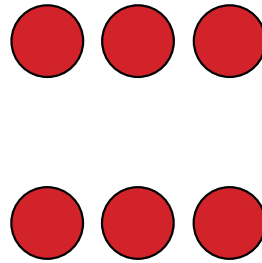

9

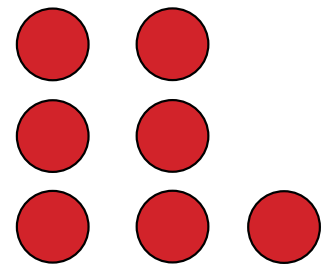

9

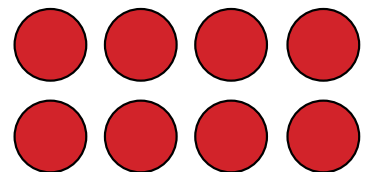



9



●	●	●	●	●
●	●	●		

9

●	●	●	●	●
●	●	●		



9

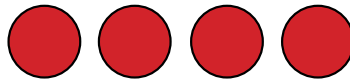

●	●	●	●	●

9

●	●	●	●	●

●	●	●	●	

9

●	●	●	●	●
●	●	●	●	





10

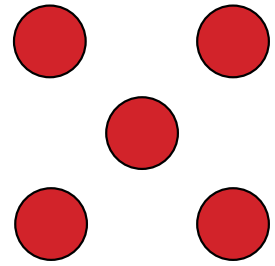
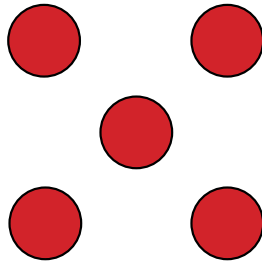

10

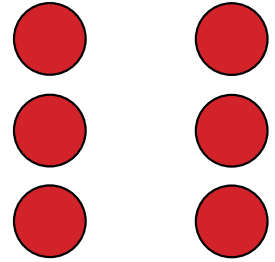
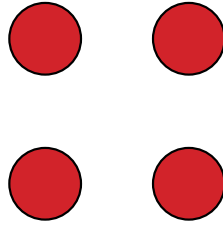

10

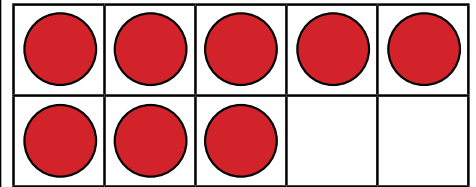

10

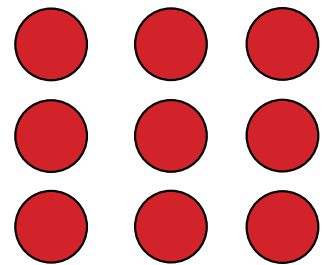

10

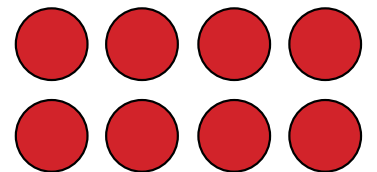



10

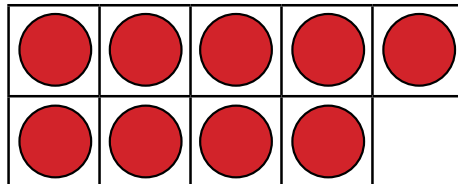

10

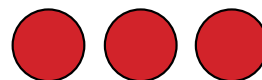
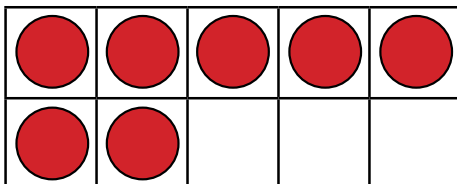

10

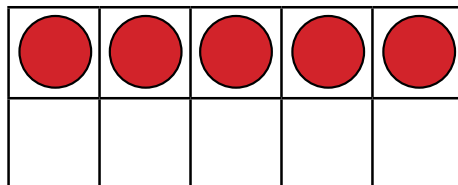
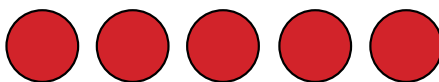

10

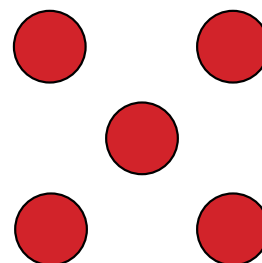
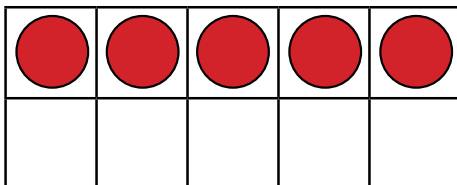

10

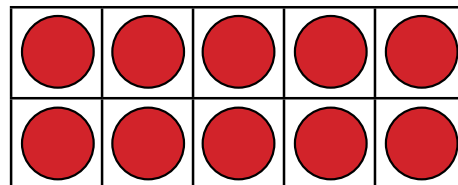
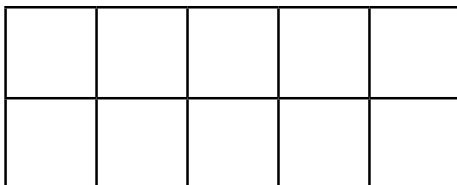



11

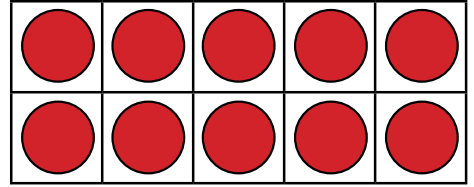

11

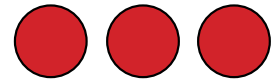
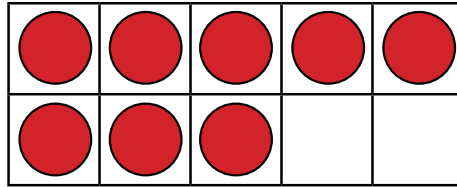

11

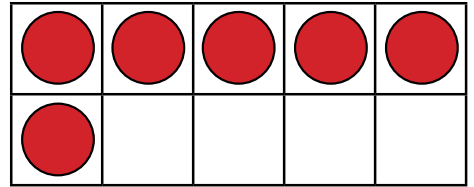
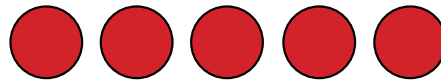

11

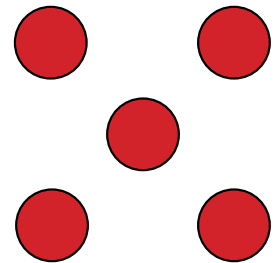
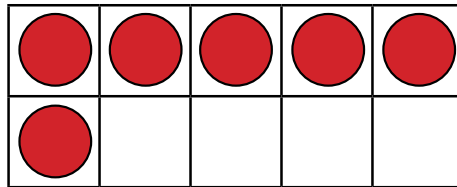

11

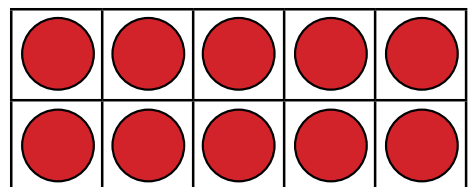
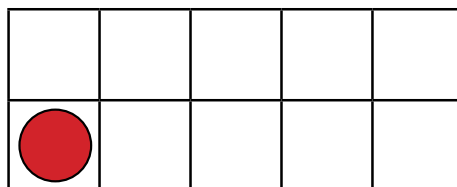



11

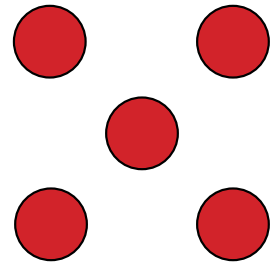
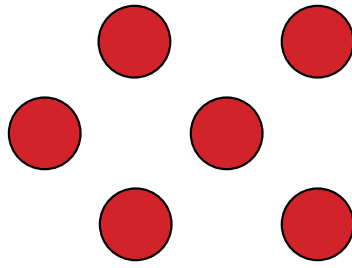

11

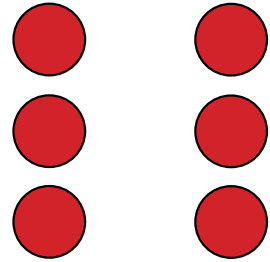
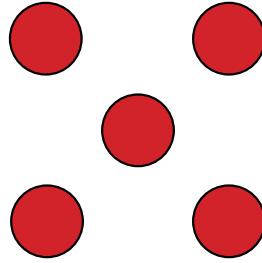

11

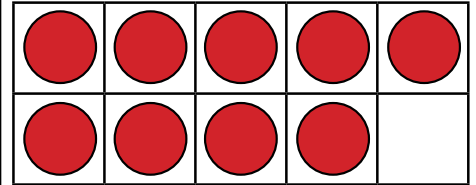

11

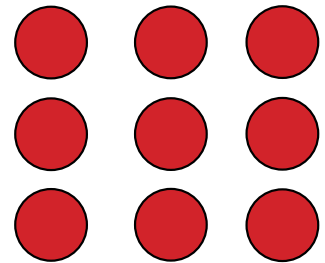
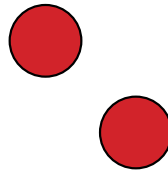

11

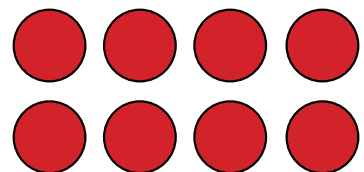
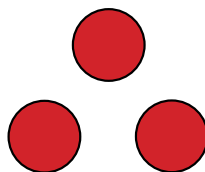



12

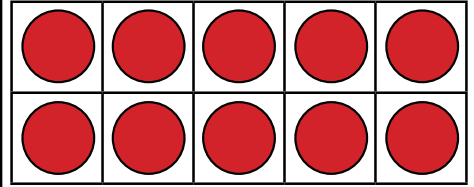
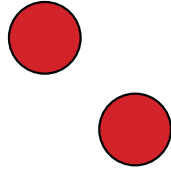

12

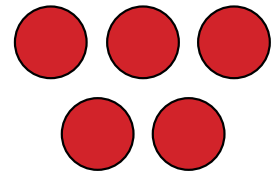
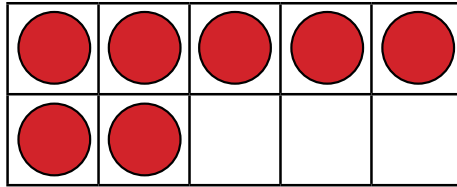

12

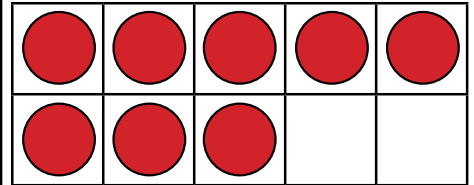
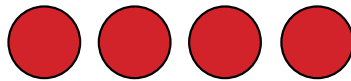

12

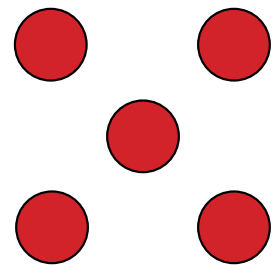
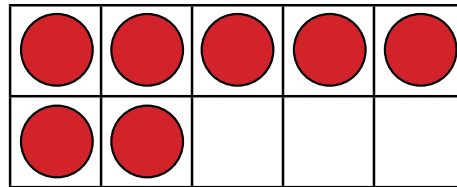

12

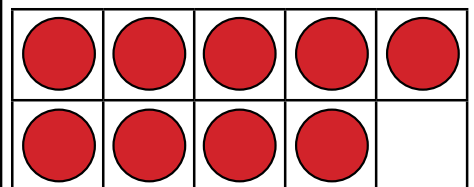
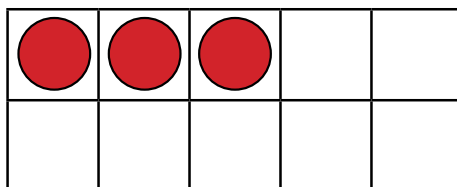



12

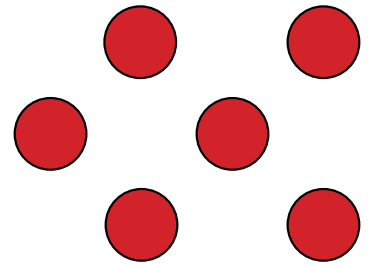
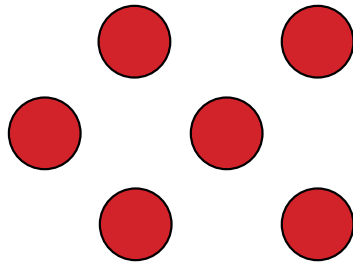

12

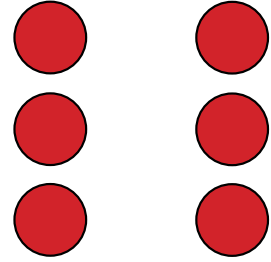
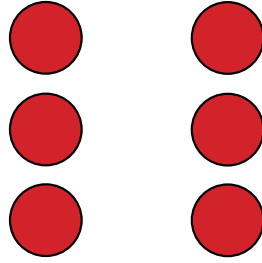

12

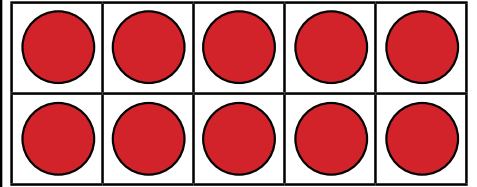

12

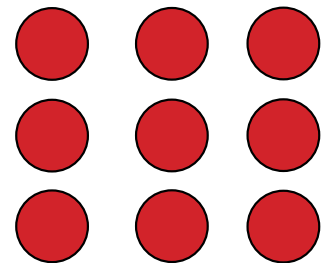
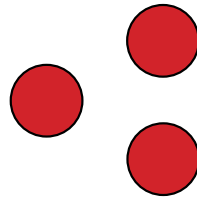

12

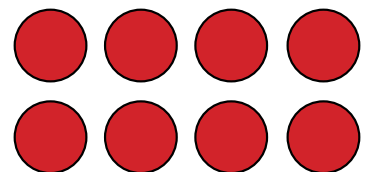
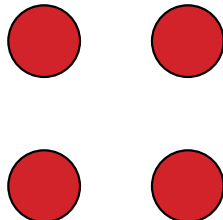

Cartes de nombres de 0 à 100

0

1

2

3



Cartes de nombres de 0 à 100

(suite)

4

5

6

7



Cartes de nombres de 0 à 100

(suite)

8

9

10

11



Cartes de nombres de 0 à 100

(suite)

12

13

14

15



Cartes de nombres de 0 à 100

(suite)

16

17

18

19



Cartes de nombres de 0 à 100

(suite)

20

21

22

23



Cartes de nombres de 0 à 100

(suite)

24

25

26

27



Cartes de nombres de 0 à 100

(suite)

28

29

30

31



Cartes de nombres de 0 à 100

(suite)

32

33

34

35



Cartes de nombres de 0 à 100

(suite)

36

37

38

39



Cartes de nombres de 0 à 100

(suite)

40

41

42

43



Cartes de nombres de 0 à 100

(suite)

44

45

46

47



Cartes de nombres de 0 à 100

(suite)

48

49

50

51



Cartes de nombres de 0 à 100

(suite)

52

53

54

55



Cartes de nombres de 0 à 100

(suite)

56

57

58

59



Cartes de nombres de 0 à 100

(suite)

60

61

62

63



Cartes de nombres de 0 à 100

(suite)

64

65

66

67

Cartes de nombres de 0 à 100

(suite)

68

69

70

71



Cartes de nombres de 0 à 100

(suite)

72

73

74

75



Cartes de nombres de 0 à 100

(suite)

76

77

78

79



Cartes de nombres de 0 à 100

(suite)

80

81

82

83



Cartes de nombres de 0 à 100

(suite)

84

85

86

87



Cartes de nombres de 0 à 100

(suite)

88

89

90

91



Cartes de nombres de 0 à 100

(suite)

92

93

94

95



Cartes de nombres de 0 à 100

(suite)

96

97

98

99



Cartes de nombres de 0 à 100

(suite)

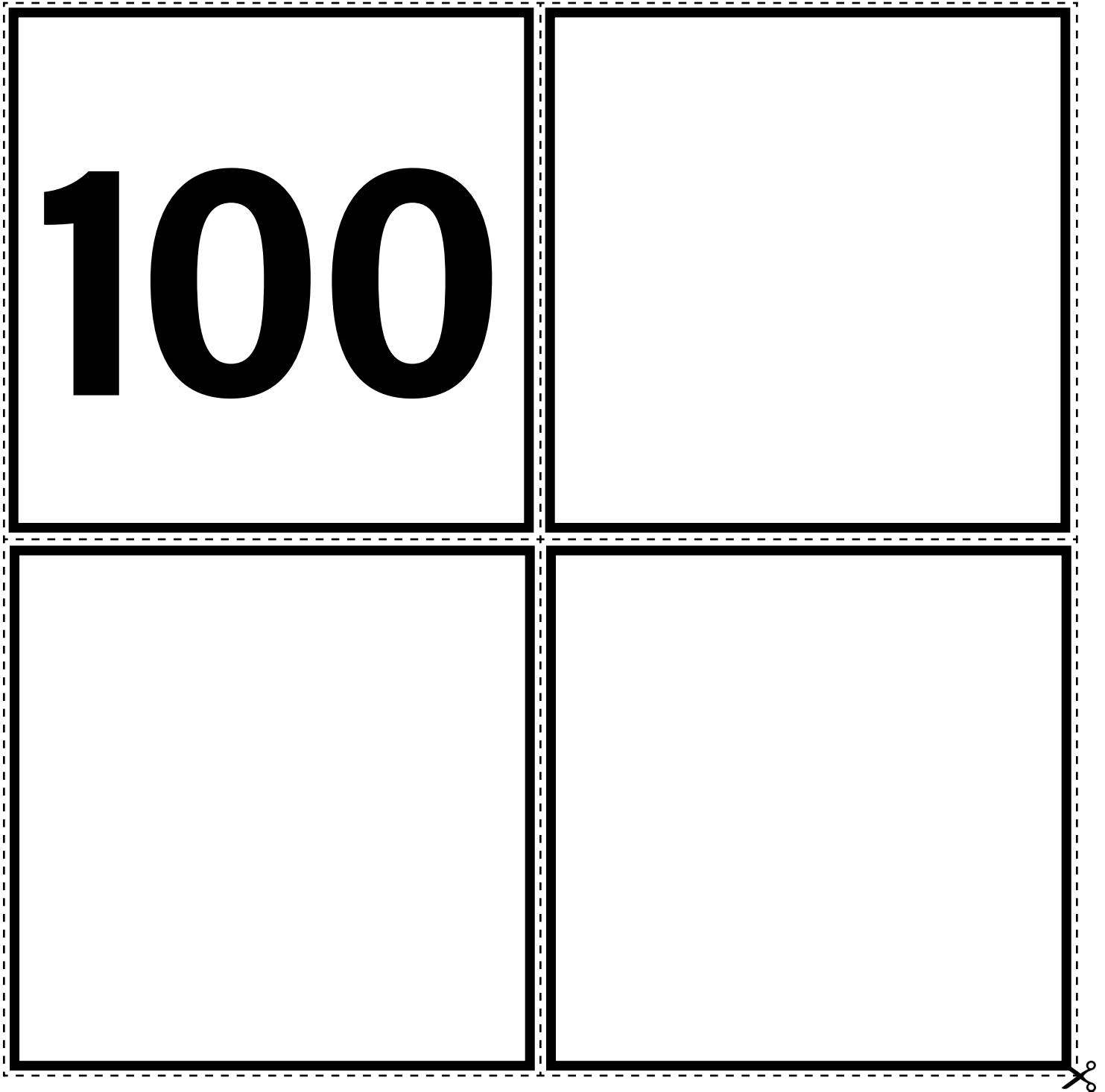



Cartes de symboles d'opérations

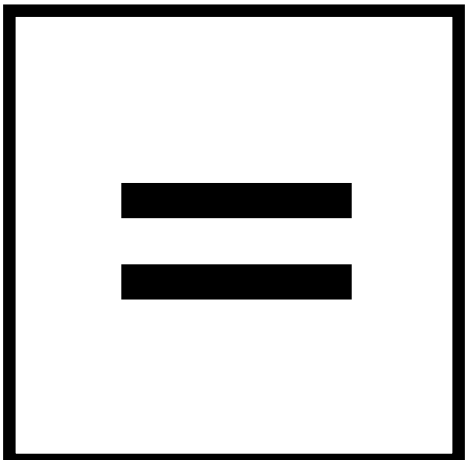
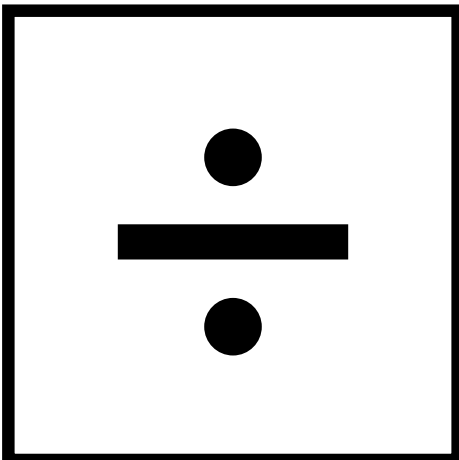
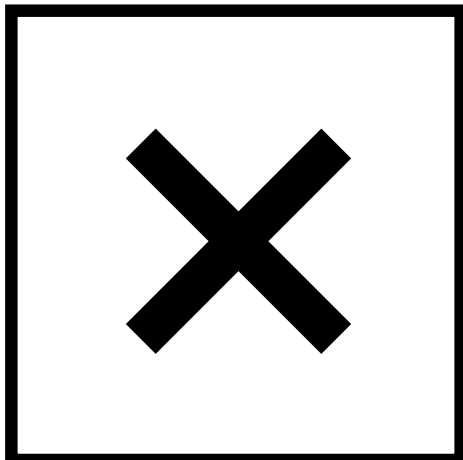
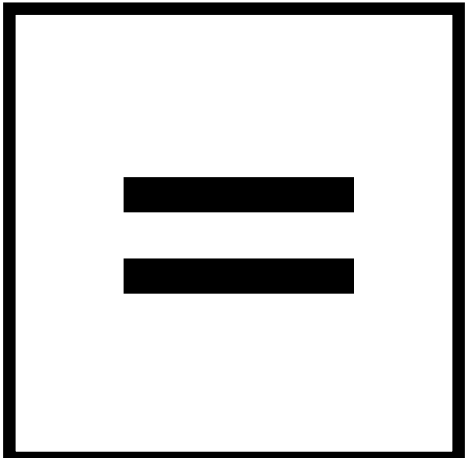
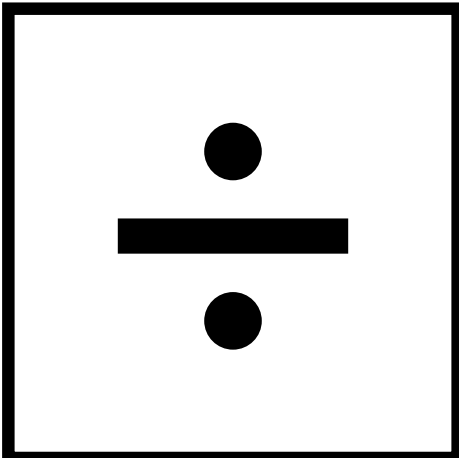
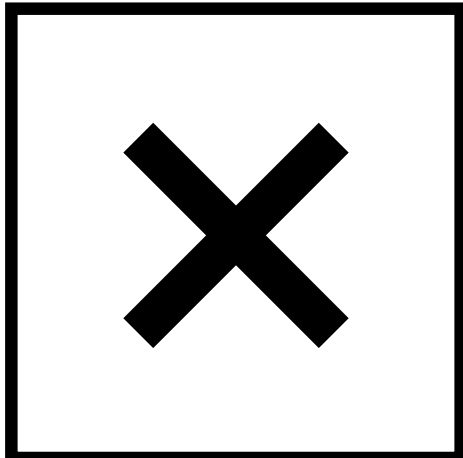
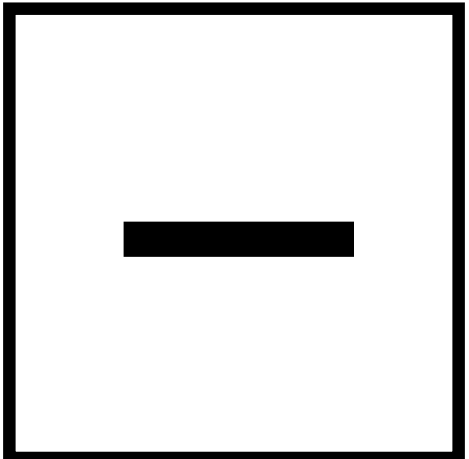
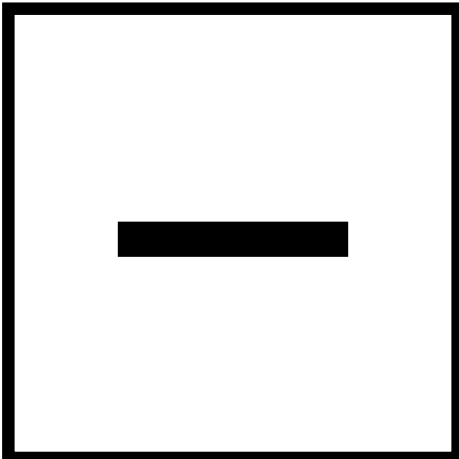
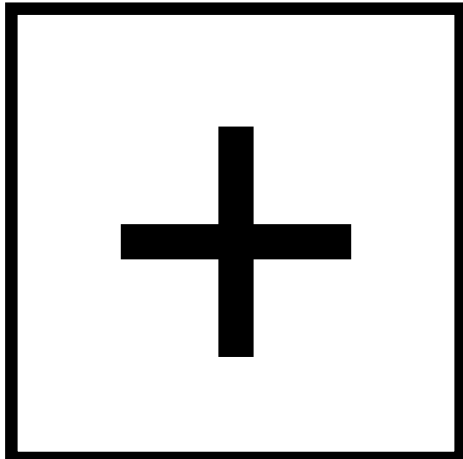
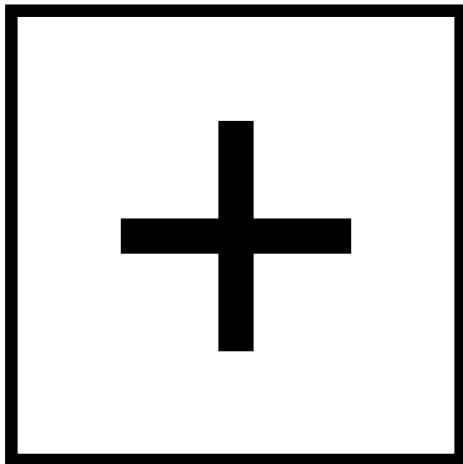

Cartes de reconnaissance globale avec les doigts de la main (1 à 10)

Cartes de reconnaissance globale avec les doigts de la main (1 à 10) (suite)

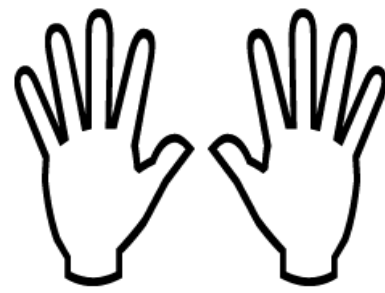
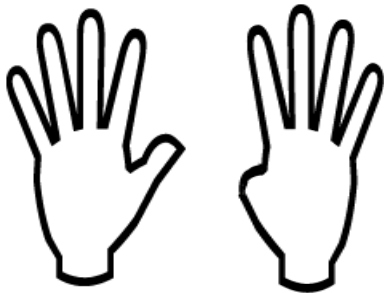
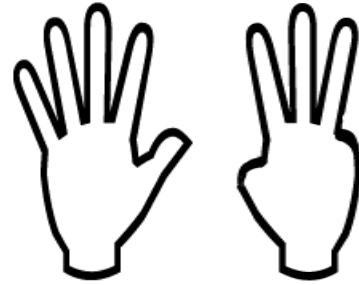
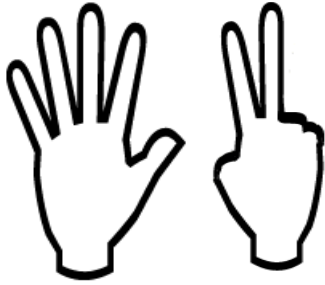

Cartes de reconnaissance globale avec les doigts de la main (1 à 10)



Cartes de reconnaissance globale avec les doigts de la main (1 à 10) (suite)

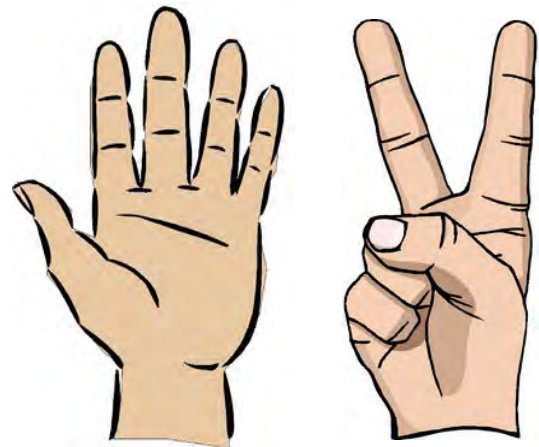
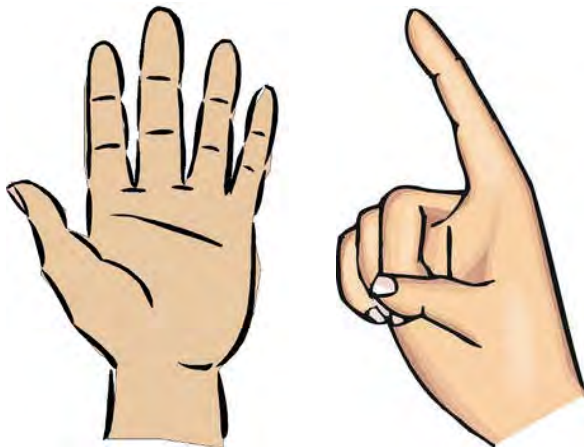

Cartes de reconnaissance globale avec les doigts de la main (1 à 10)

(suite)

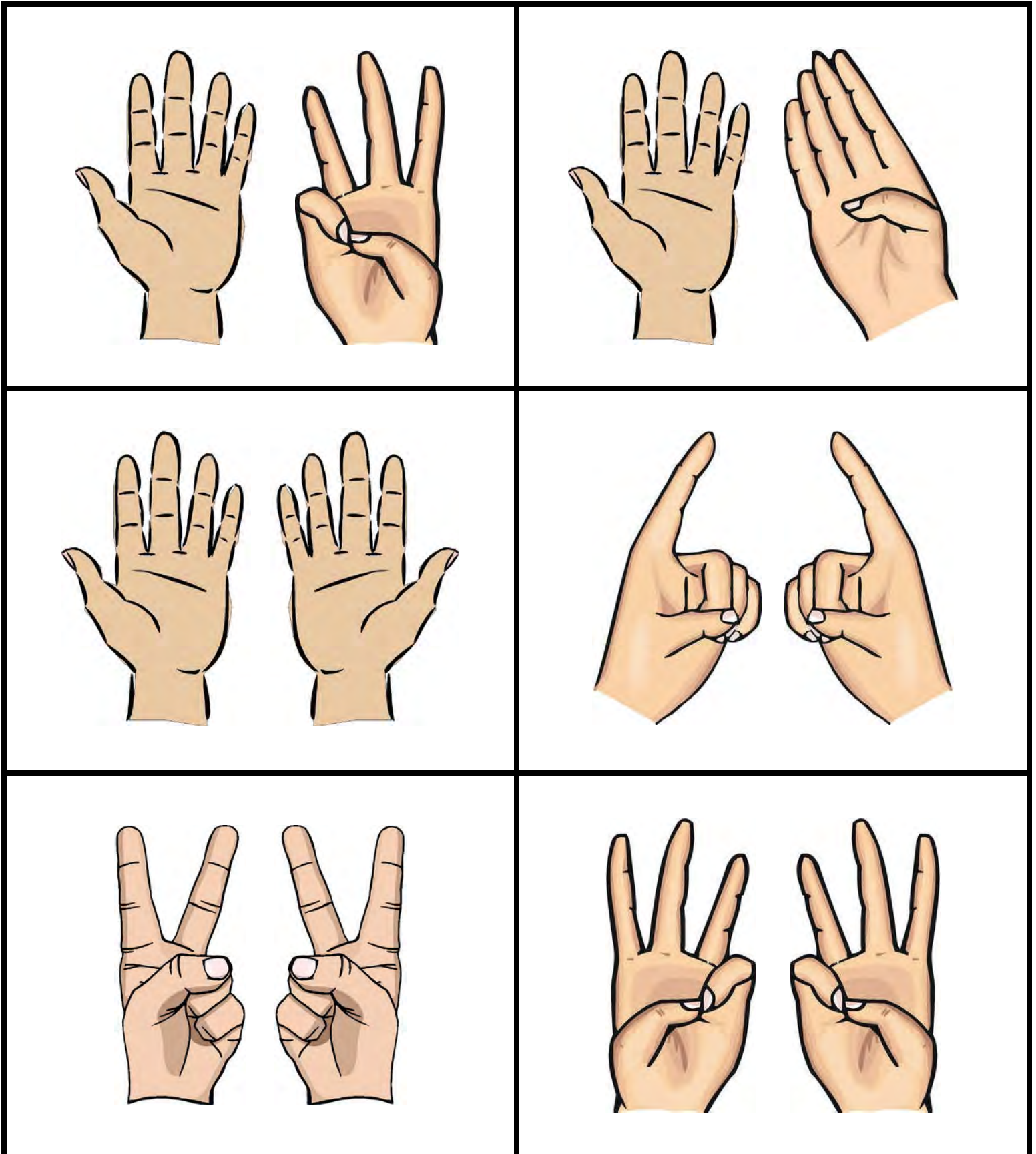

Cartes de reconnaissance globale avec les doigts de la main (1 à 10) (suite)

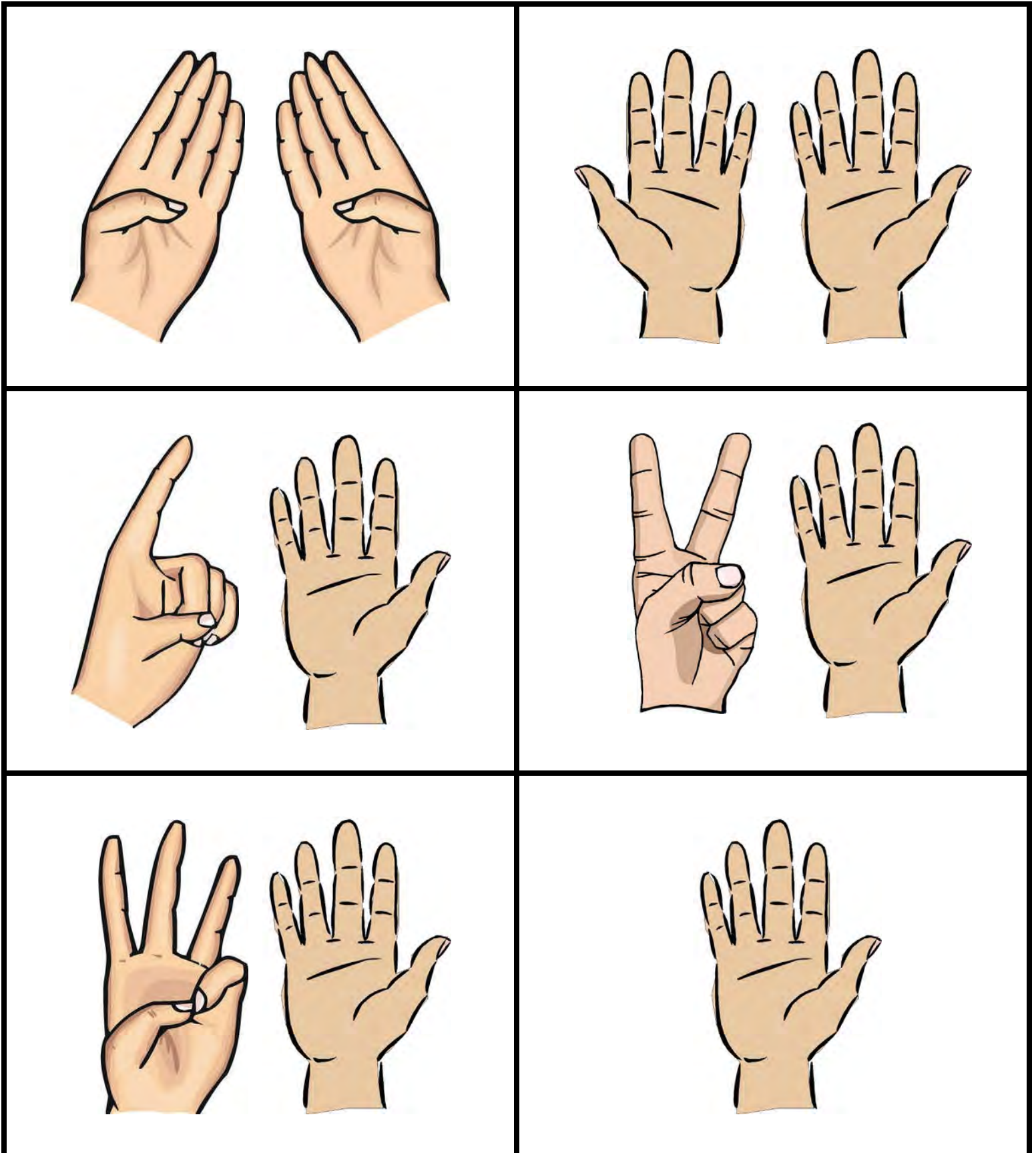

Constellations de points familiers et non familiers (1 à 10)

Format rectangulaire



Constellations de points familiers et non familiers (1 à 10)

Format rectangulaire (suite)

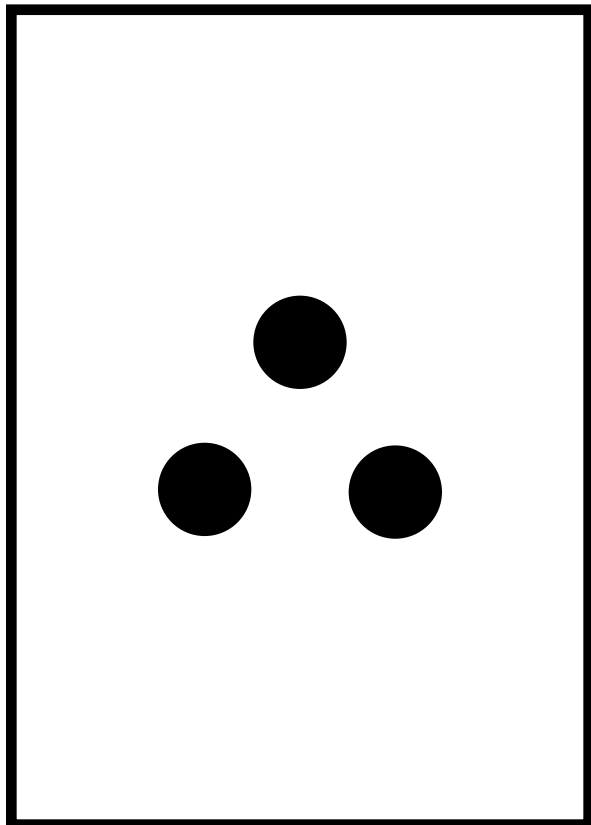
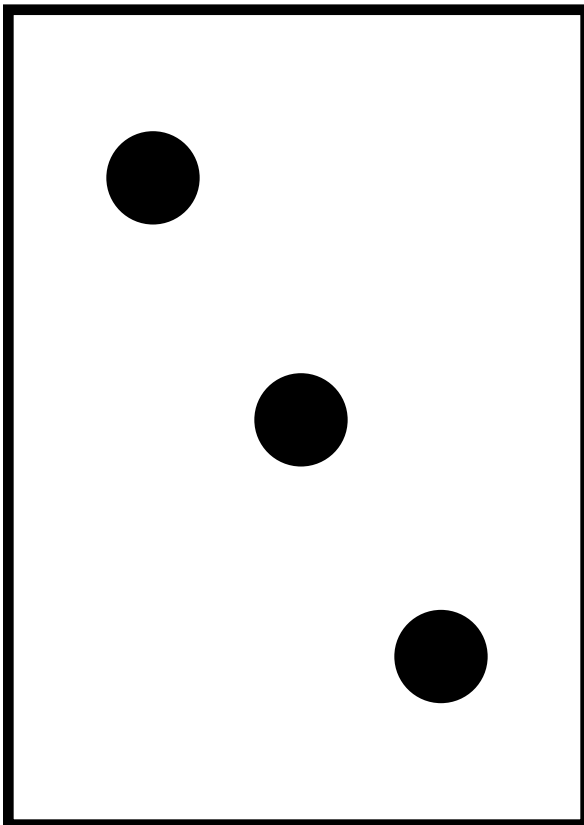
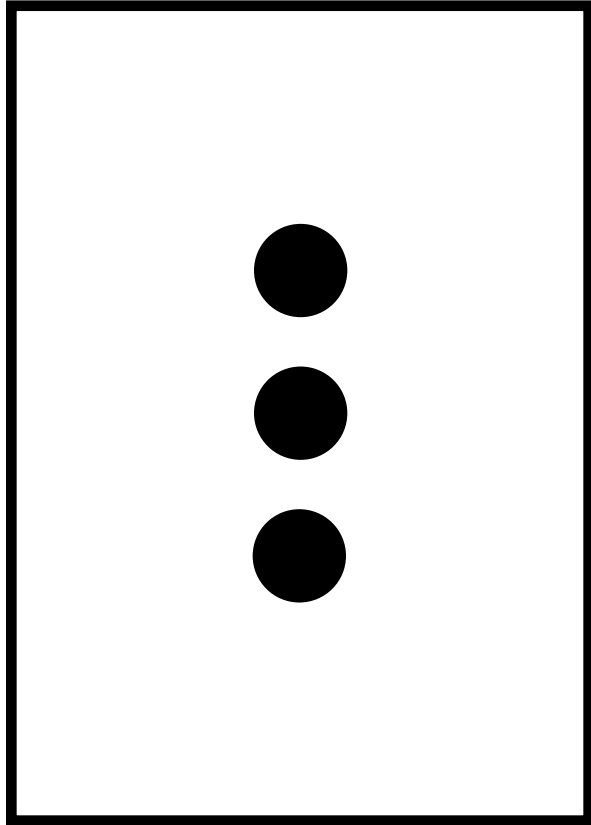
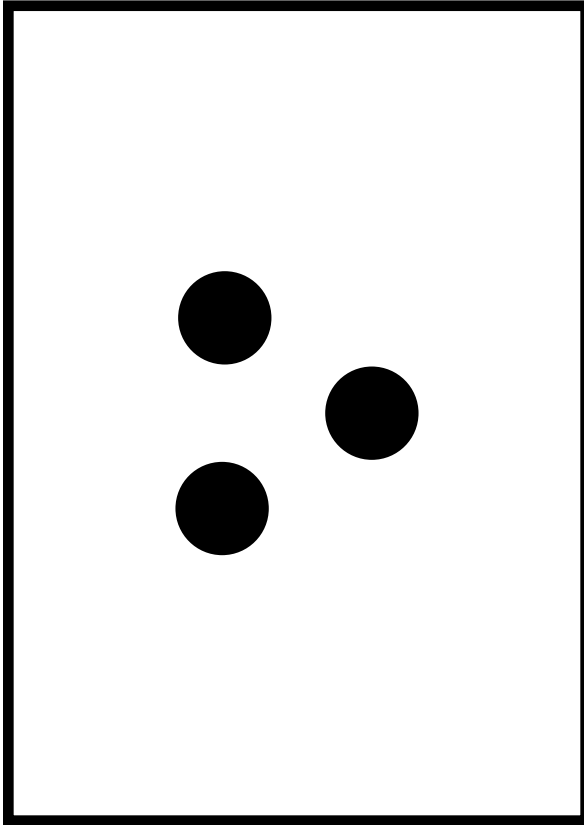

Constellations de points familiers et non familiers (1 à 10)

Format rectangulaire (suite)



The image shows four rectangular boxes arranged in a 2x2 grid, each containing a different arrangement of four black dots. The boxes are separated by dashed lines, and a scissors icon is in the top right corner of the grid.

- Top-left box:** Four dots arranged in a 2x2 square.
- Top-right box:** Four dots arranged in a descending staircase pattern from top-left to bottom-right.
- Bottom-left box:** Three dots in a vertical column on the left, and one dot to the right of the middle dot.
- Bottom-right box:** Three dots in a horizontal row at the bottom, and one dot above the middle dot.



Constellations de points familiers et non familiers (1 à 10)

Format rectangulaire (suite)

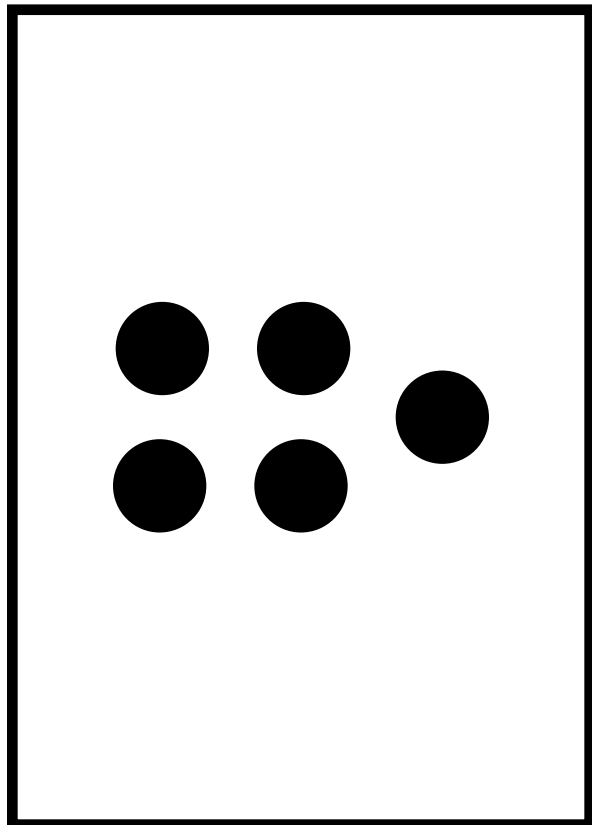
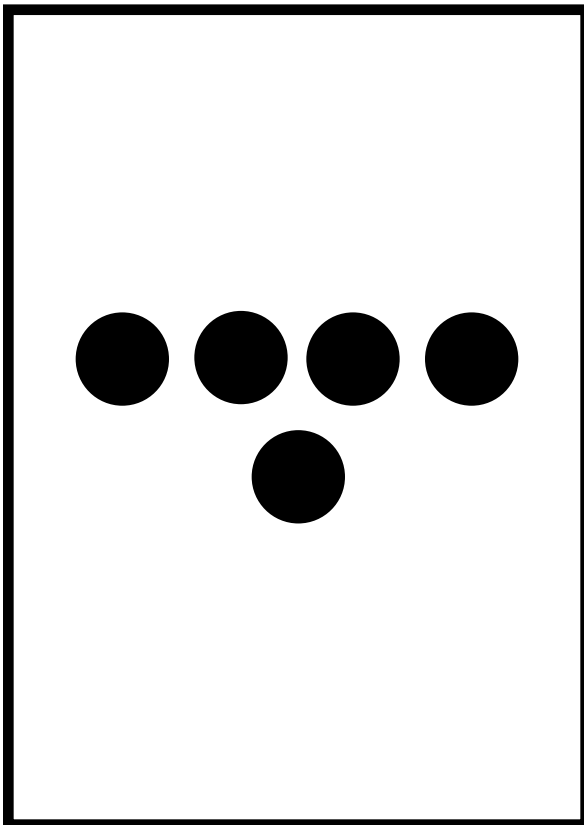
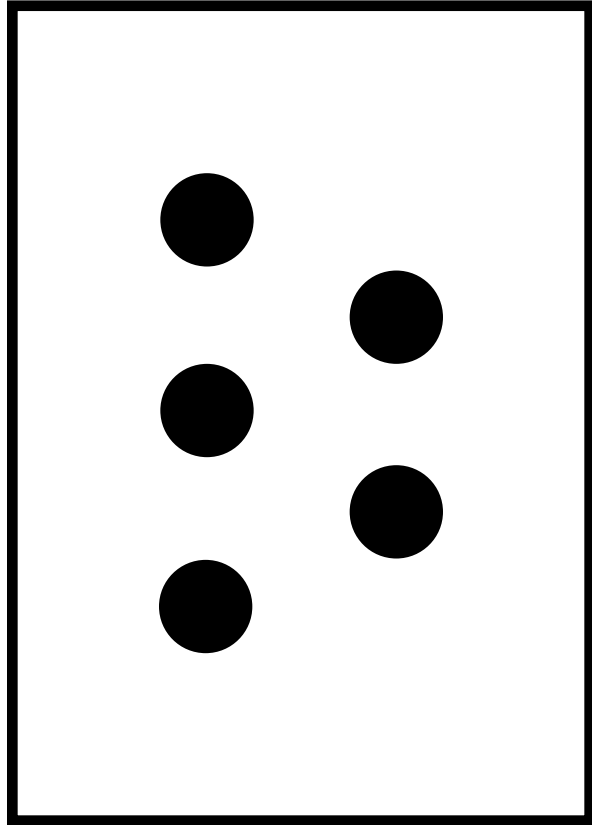
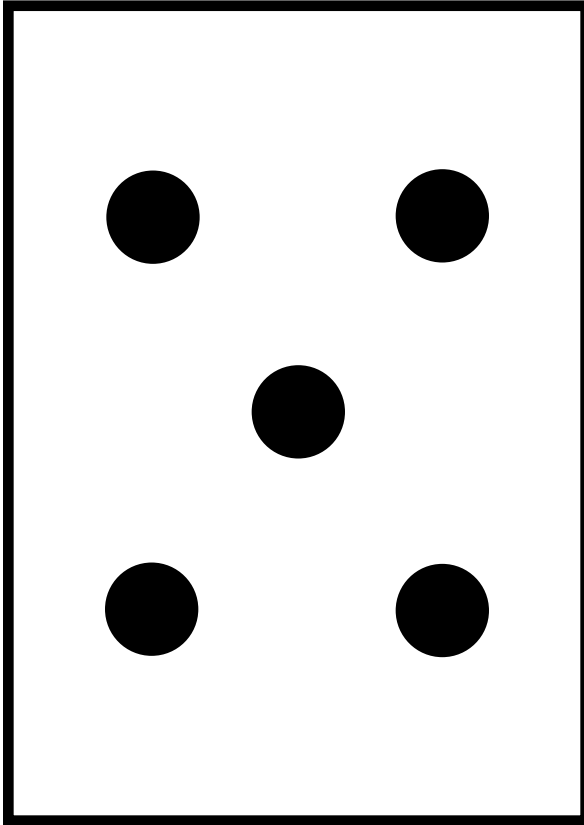

Constellations de points familiers et non familiers (1 à 10)

Format rectangulaire (suite)

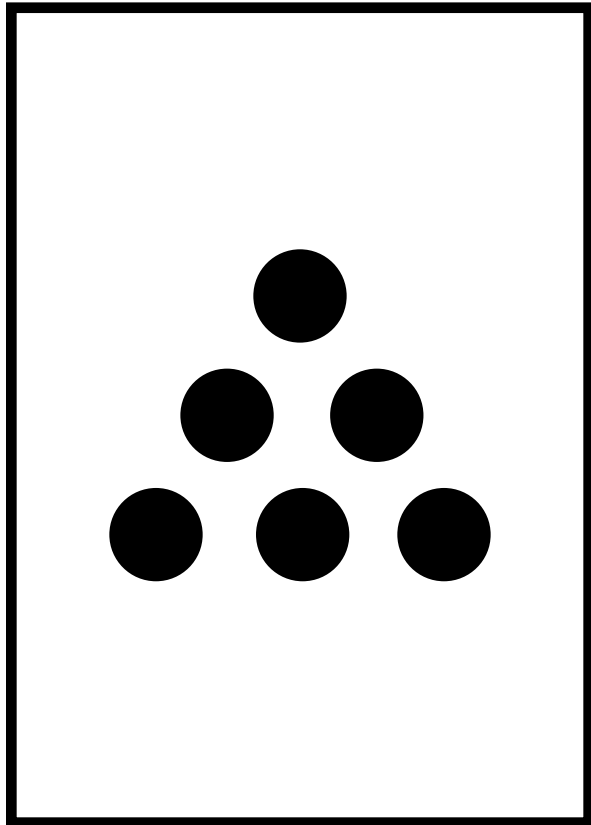
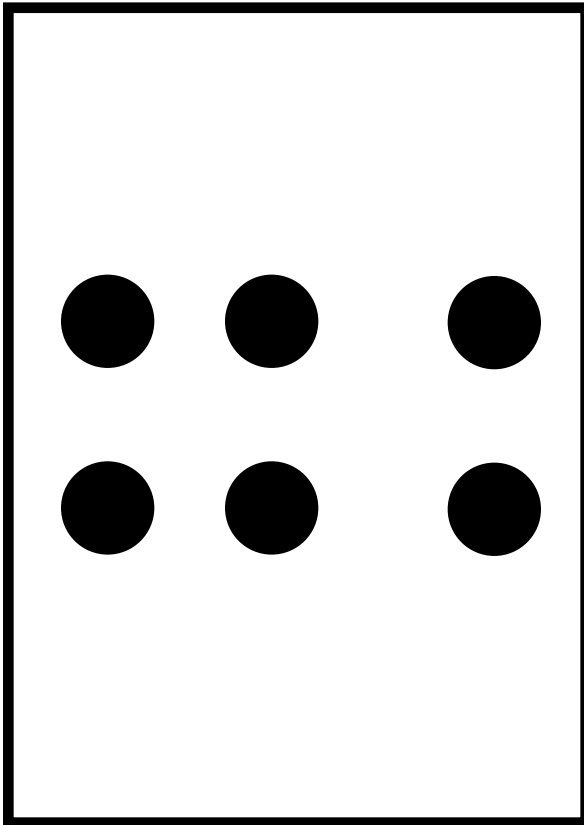
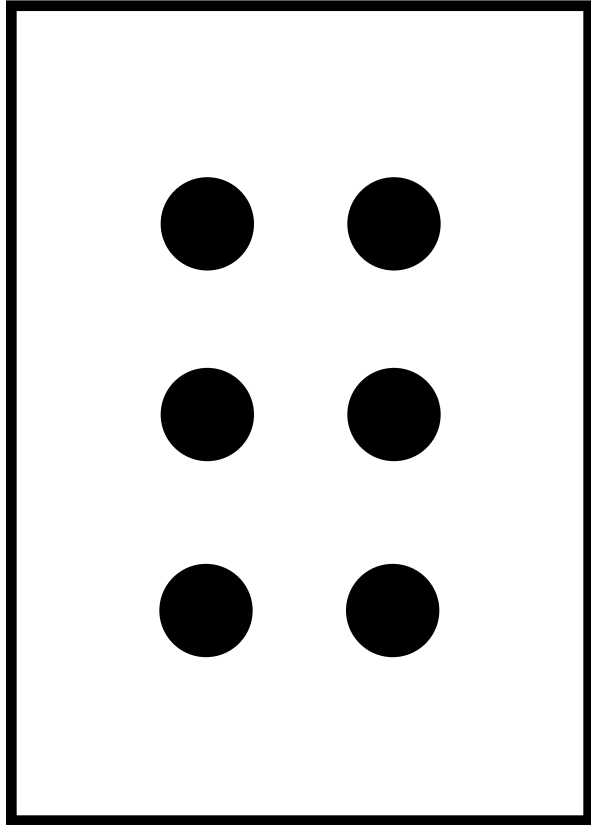
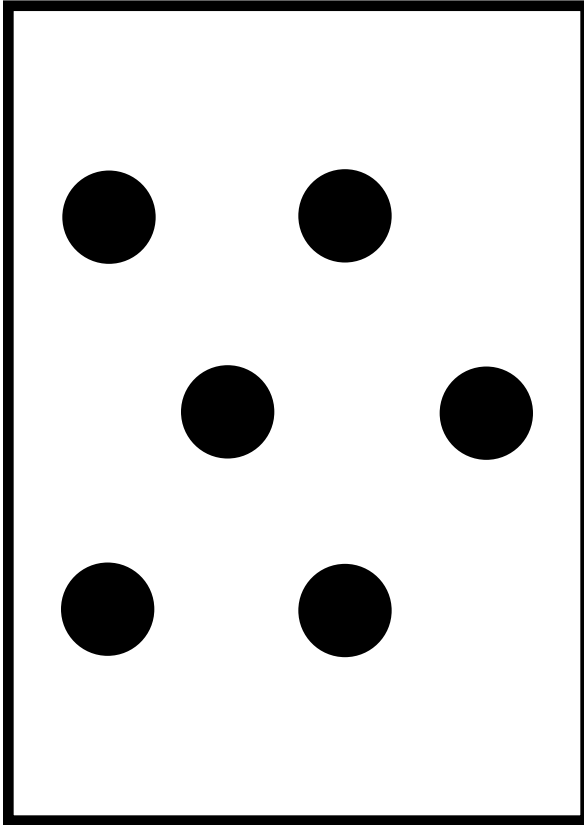

Constellations de points familiers et non familiers (1 à 10)

Format rectangulaire (suite)

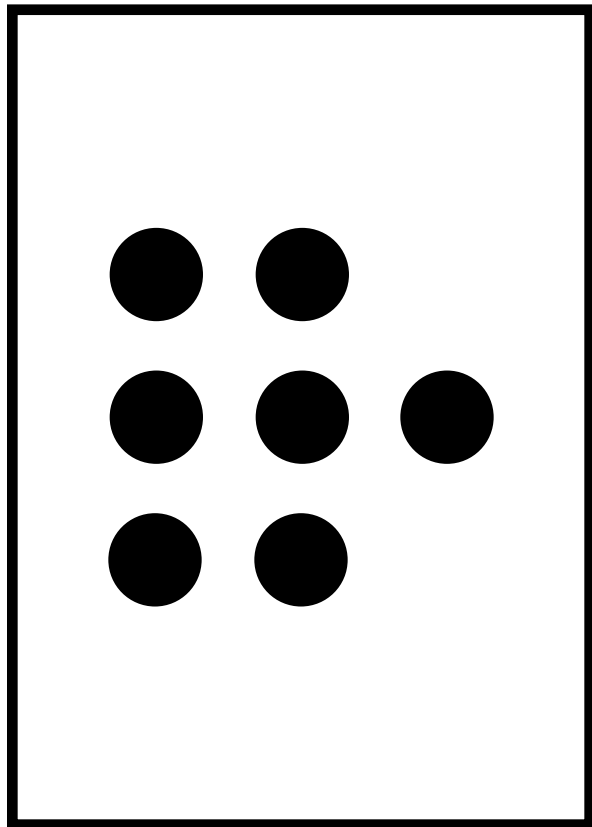
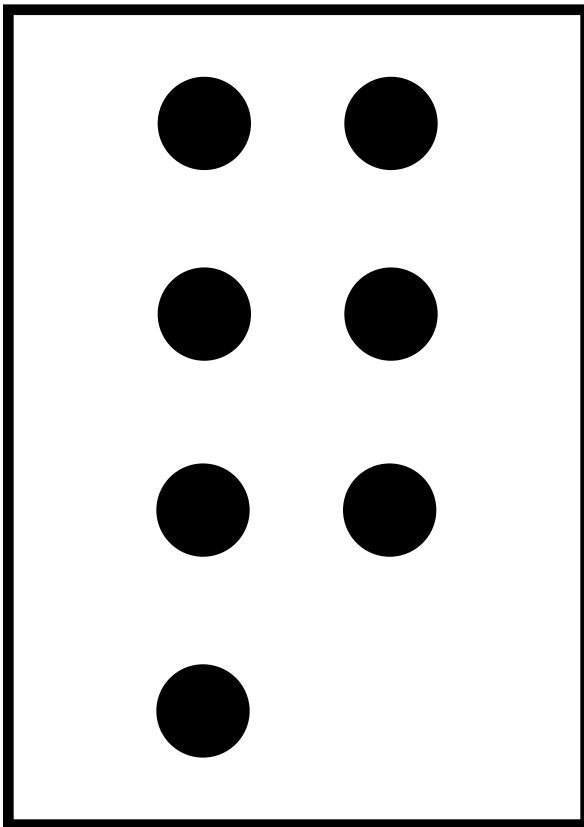
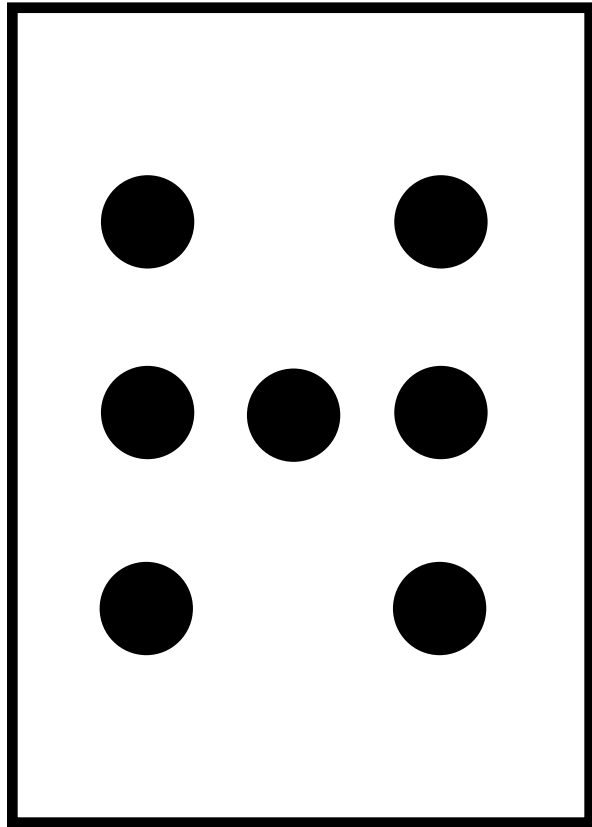
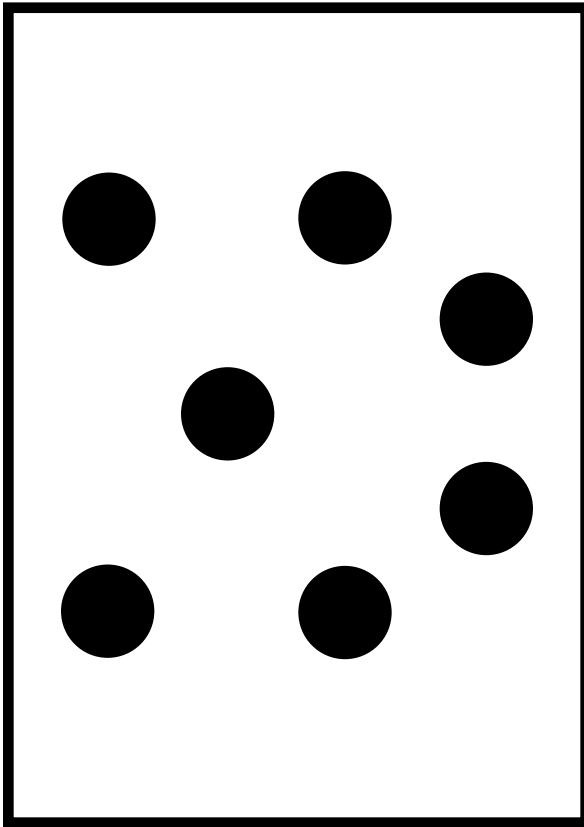

Constellations de points familiers et non familiers (1 à 10)

Format rectangulaire (suite)



The image shows four rectangular boxes arranged in a 2x2 grid, each containing a different pattern of black dots. The boxes are separated by dashed lines, and a scissors icon is located at the top right corner of the grid.

- Top-left box:** Contains 8 dots arranged in two vertical columns of four dots each.
- Top-right box:** Contains 9 dots arranged in three rows. The top row has 3 dots, the middle row has 2 dots, and the bottom row has 4 dots.
- Bottom-left box:** Contains 9 dots arranged in three rows. The top row has 3 dots, the middle row has 2 dots, and the bottom row has 4 dots.
- Bottom-right box:** Contains 10 dots arranged in two vertical columns of five dots each.



Constellations de points familiers et non familiers (1 à 10)

Format rectangulaire (suite)

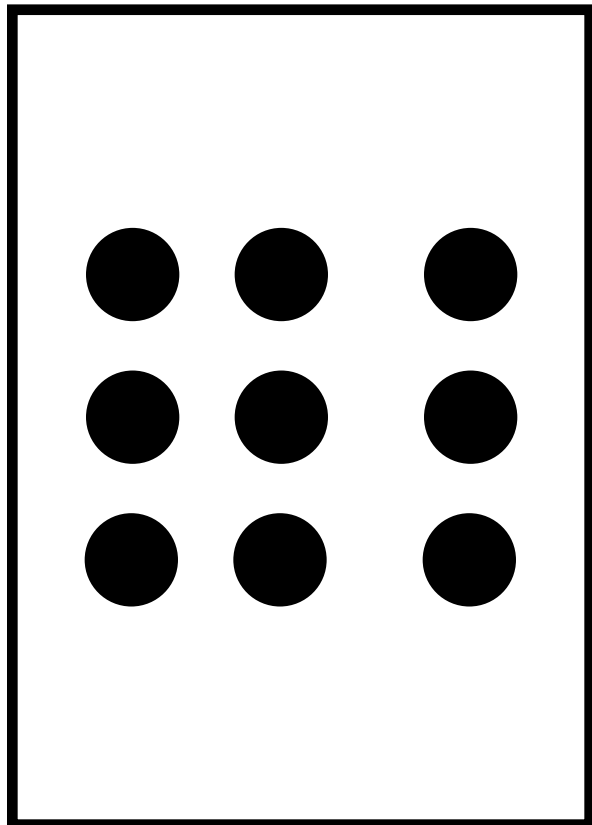
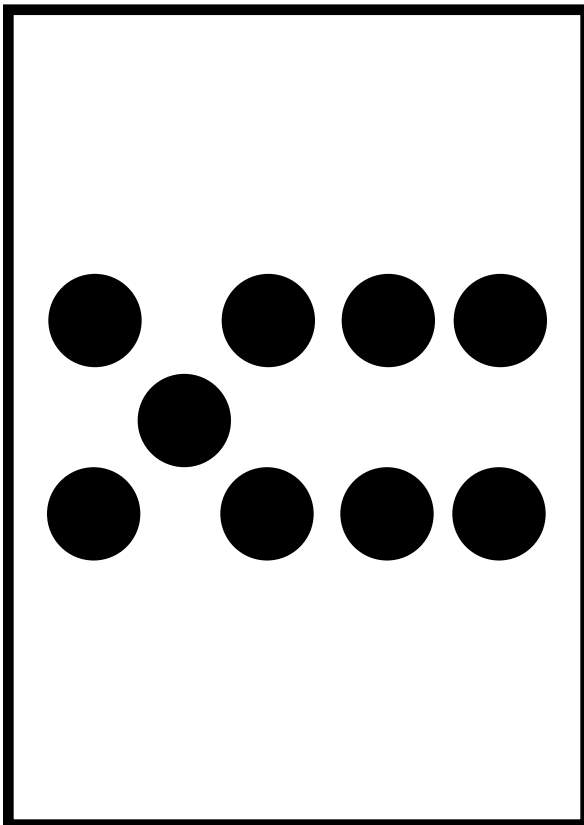
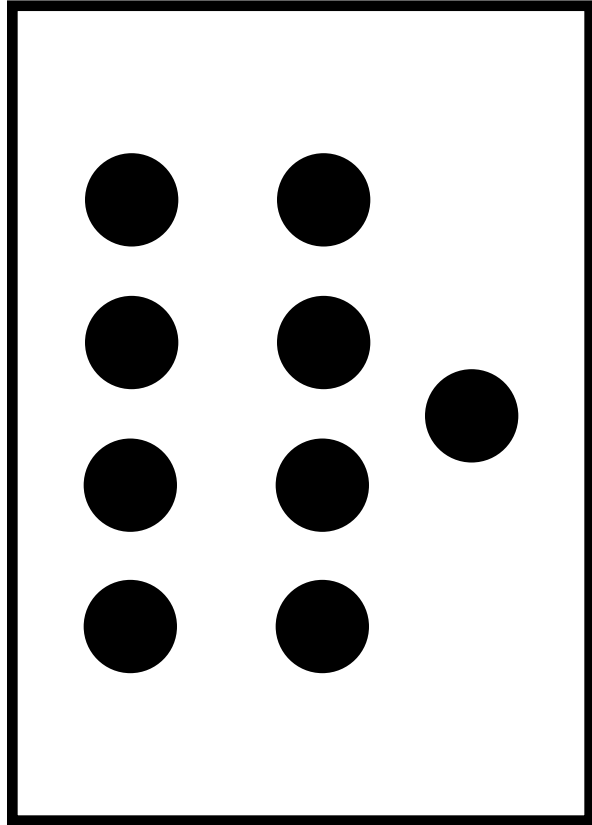
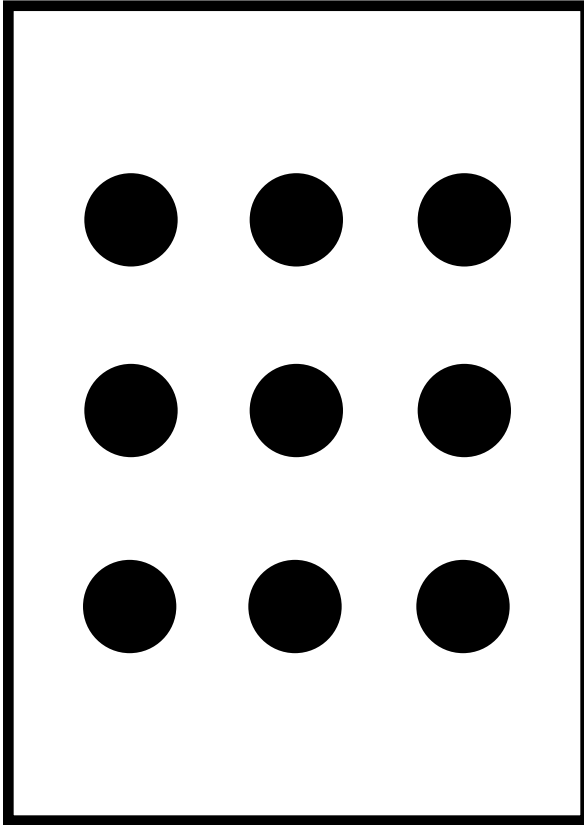

Constellations de points familiers et non familiers (1 à 10)

Format rectangulaire (suite)

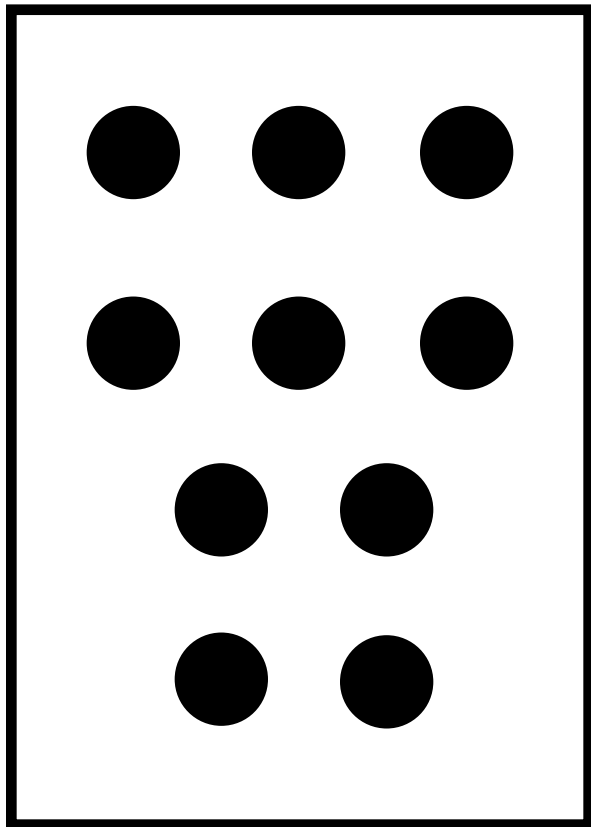
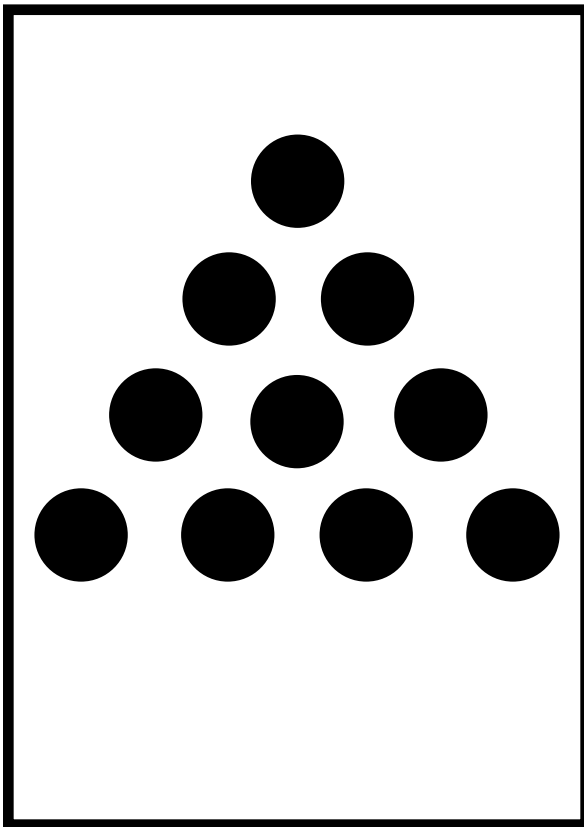
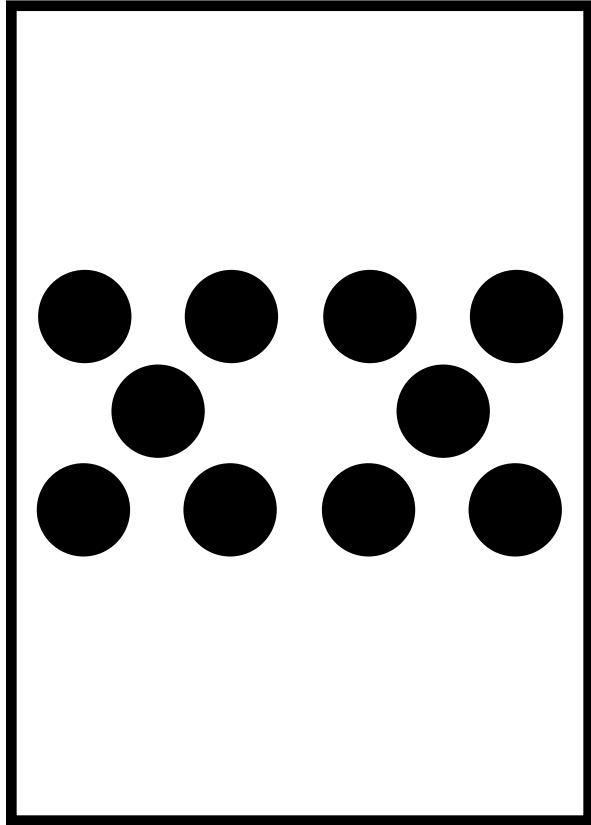
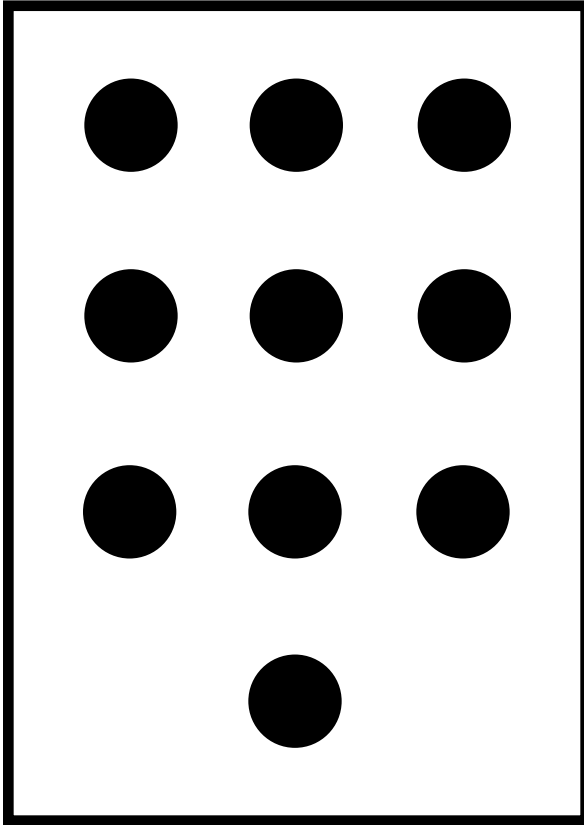

Constellations de points familiers et non familiers (1 à 10)

Format circulaire

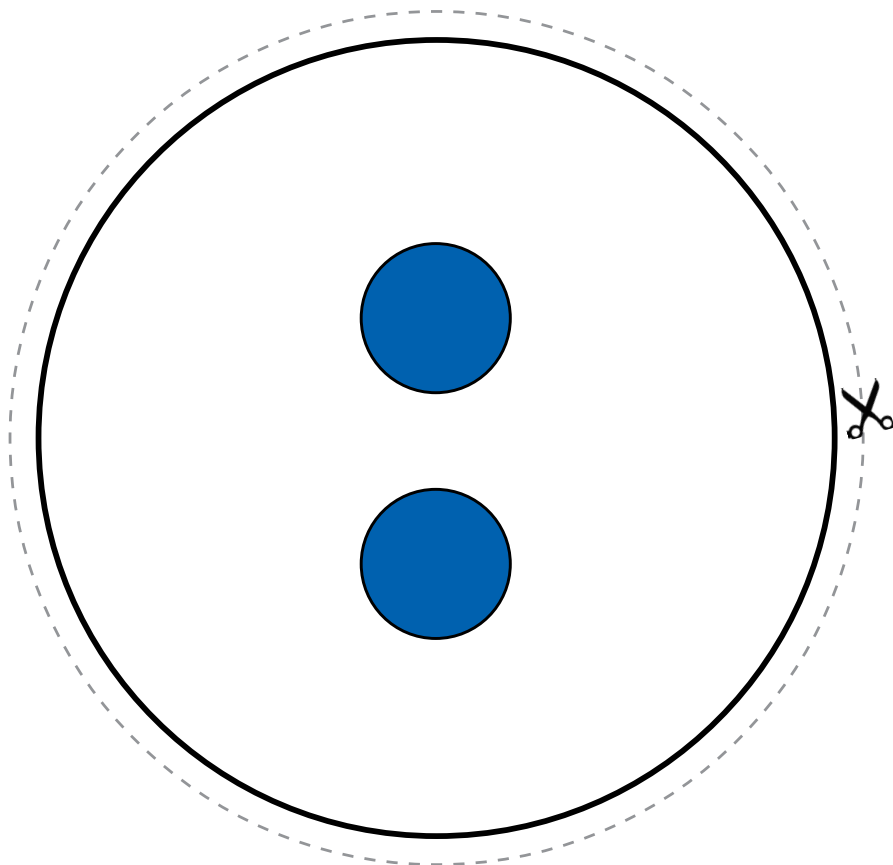
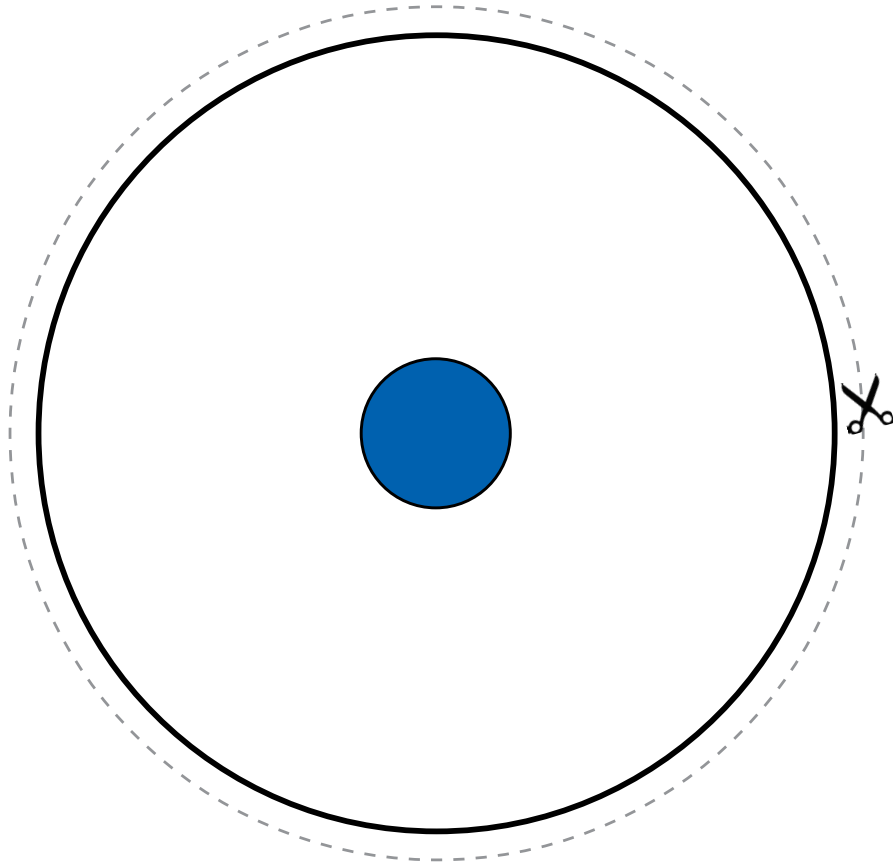

Constellations de points familiers et non familiers (1 à 10)

Format circulaire (suite)

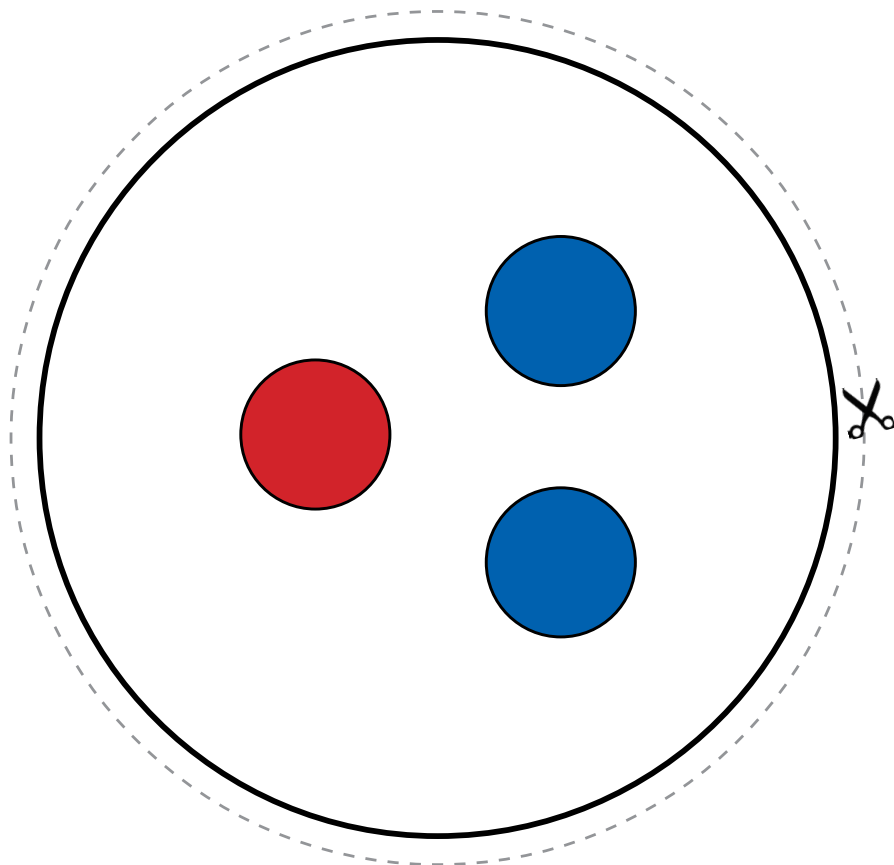
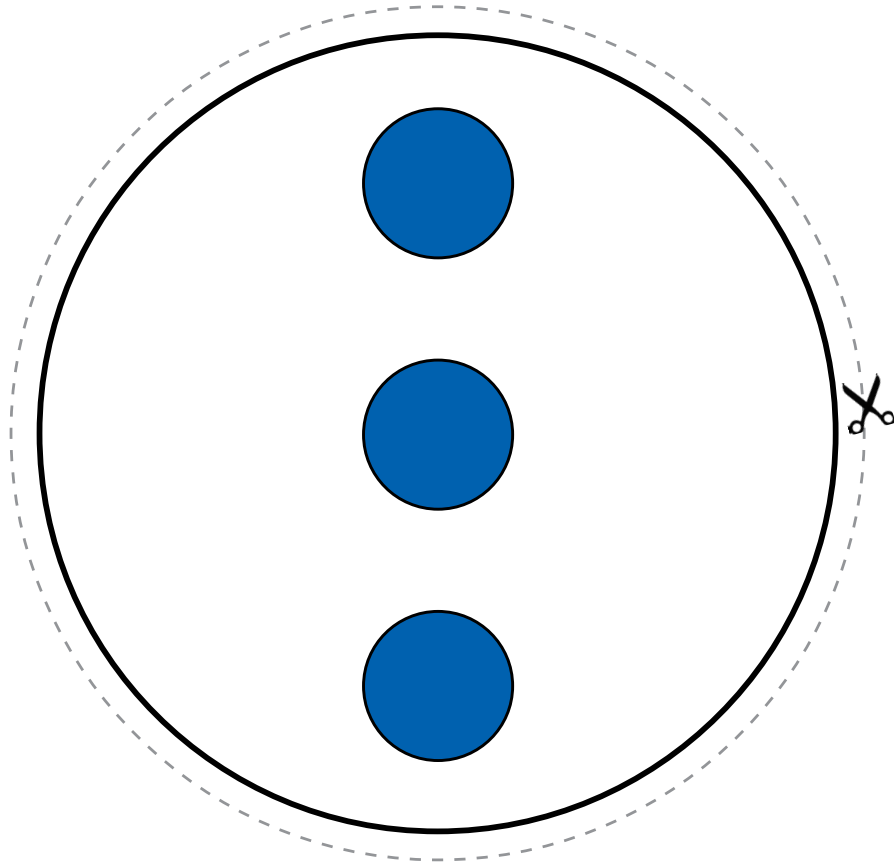

Constellations de points familiers et non familiers (1 à 10)

Format circulaire (suite)

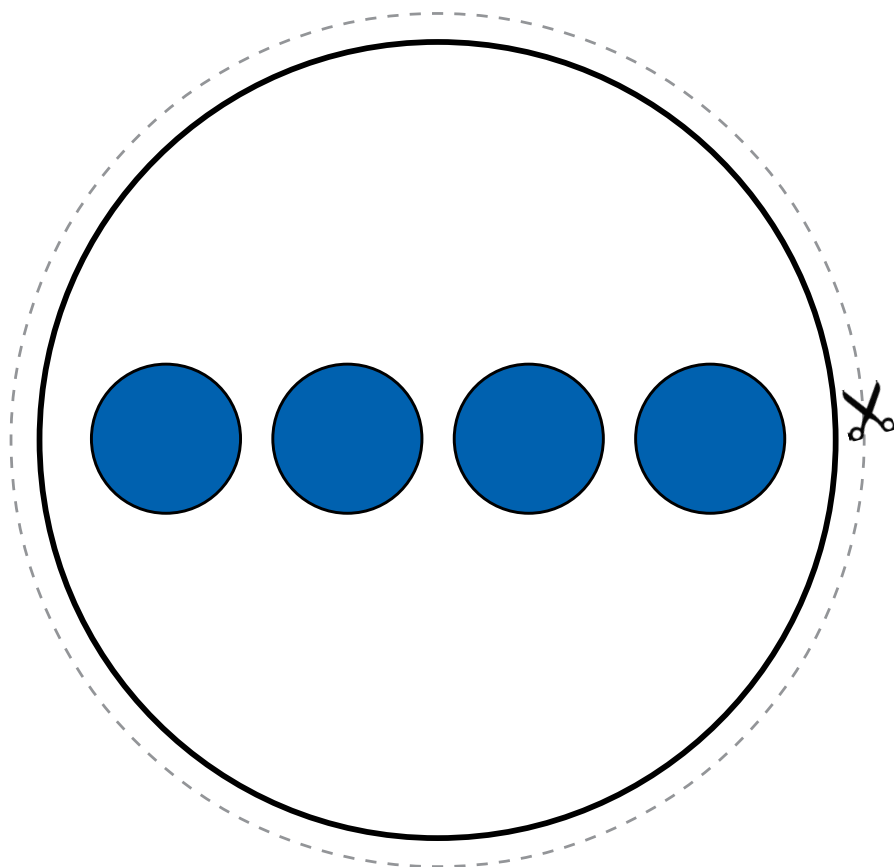
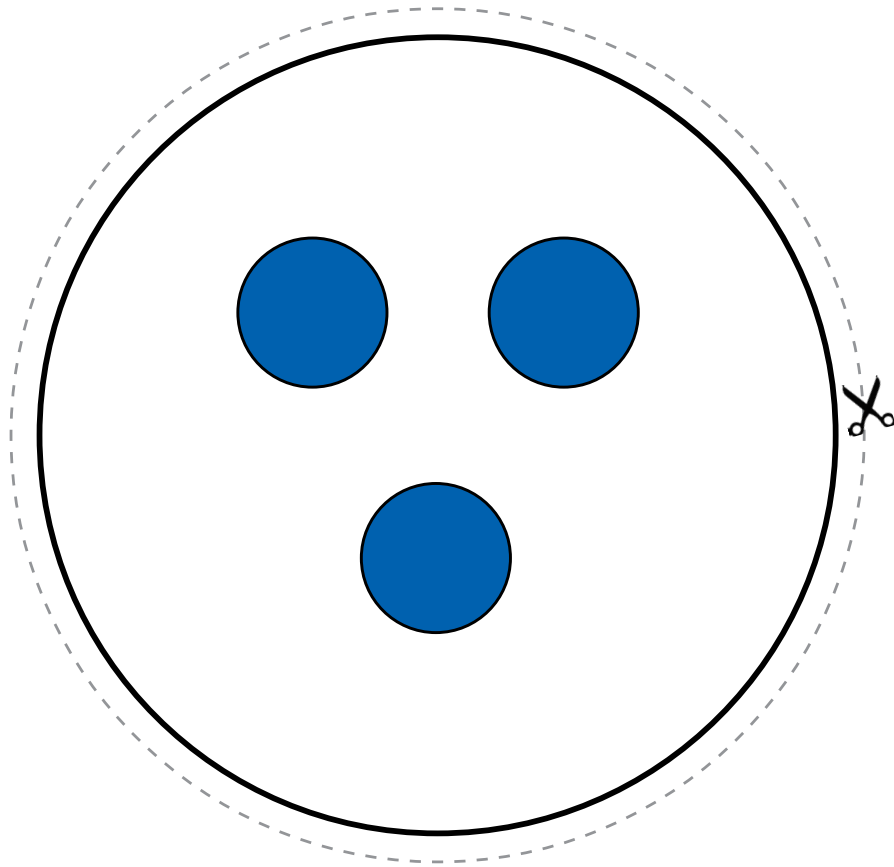

Constellations de points familiers et non familiers (1 à 10)

Format circulaire (suite)

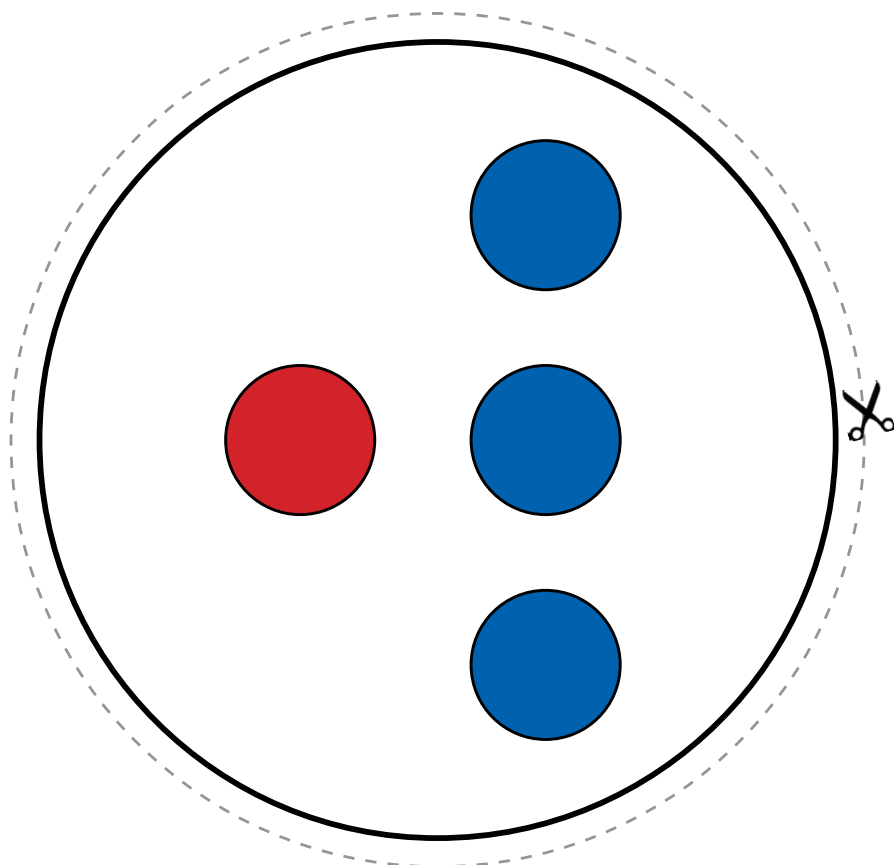
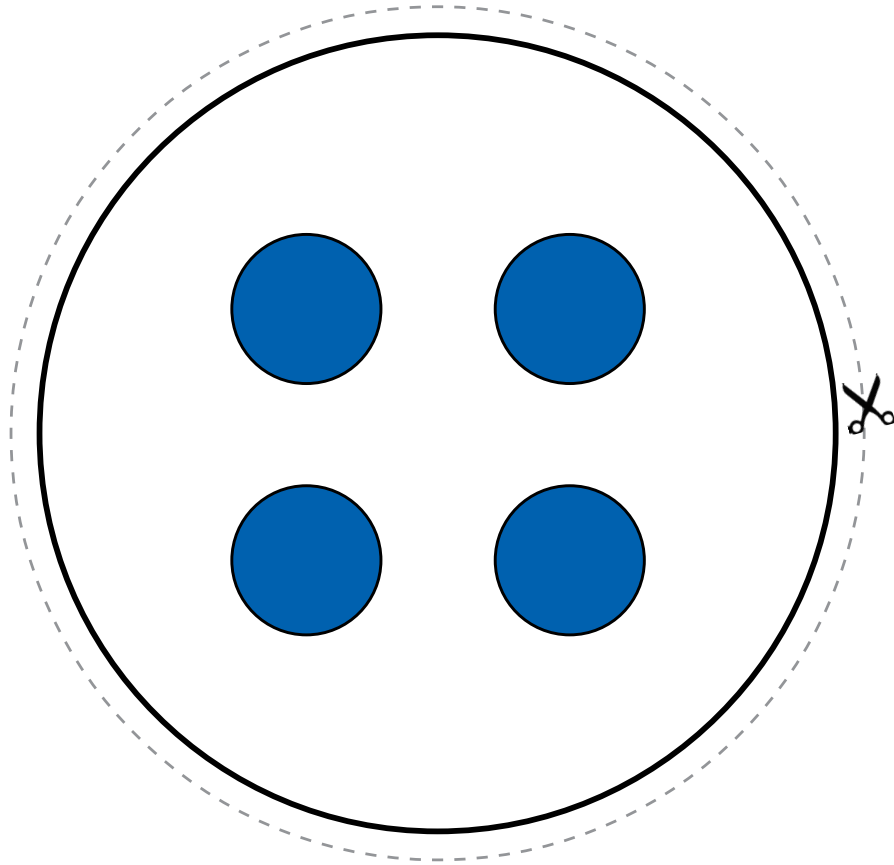

Constellations de points familiers et non familiers (1 à 10)

Format circulaire (suite)

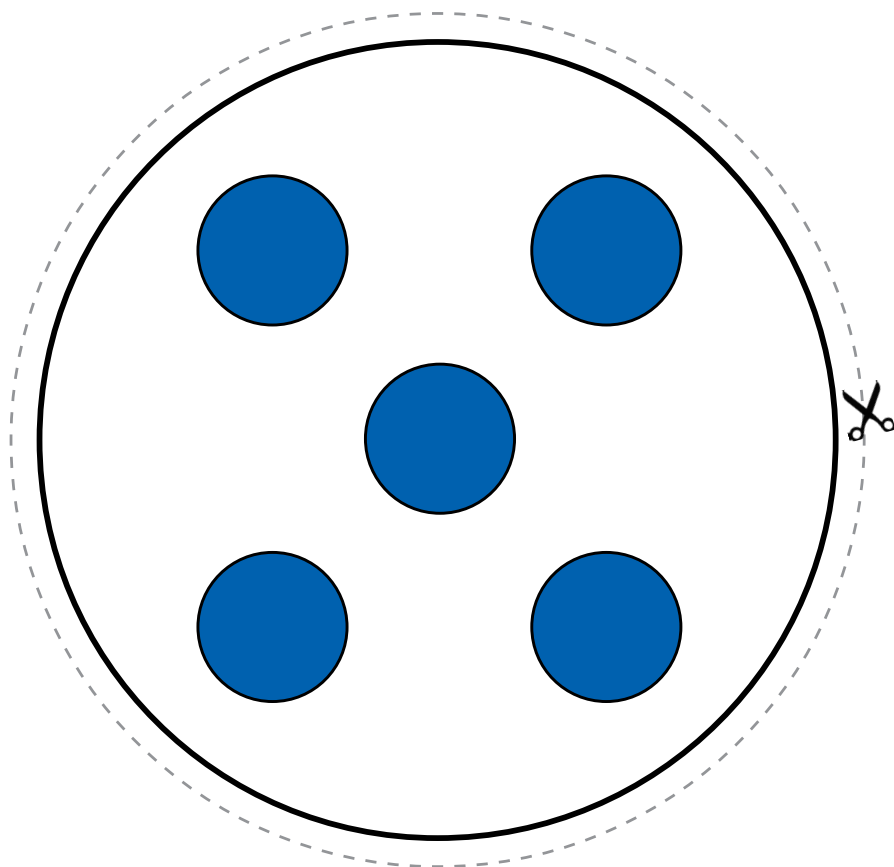
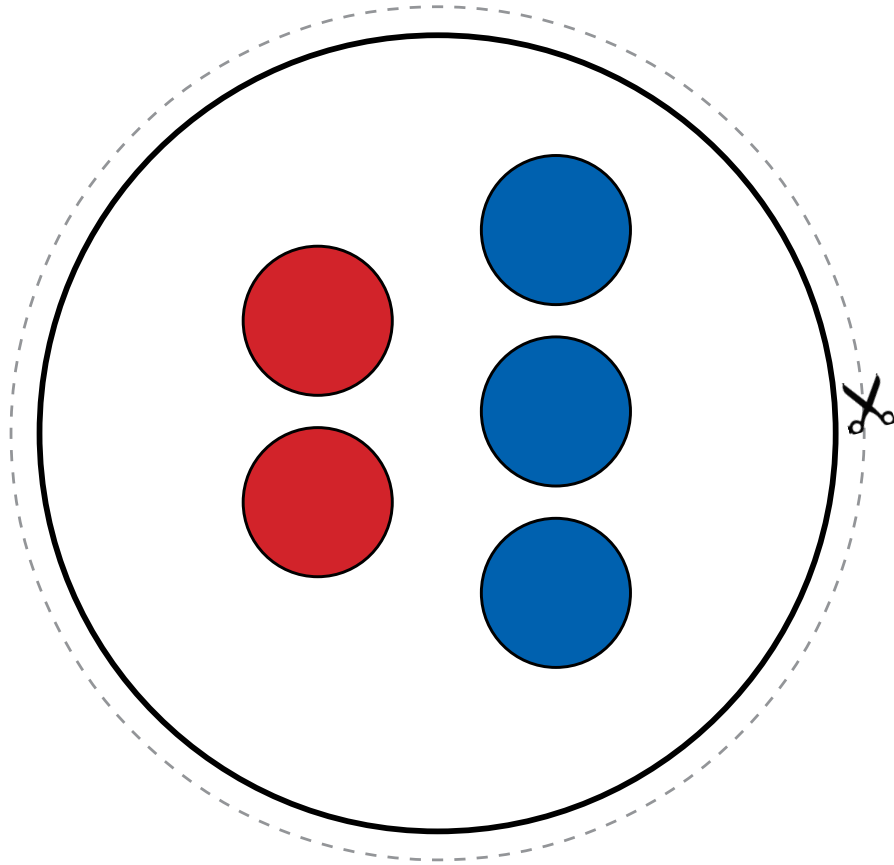

Constellations de points familiers et non familiers (1 à 10)

Format circulaire (suite)

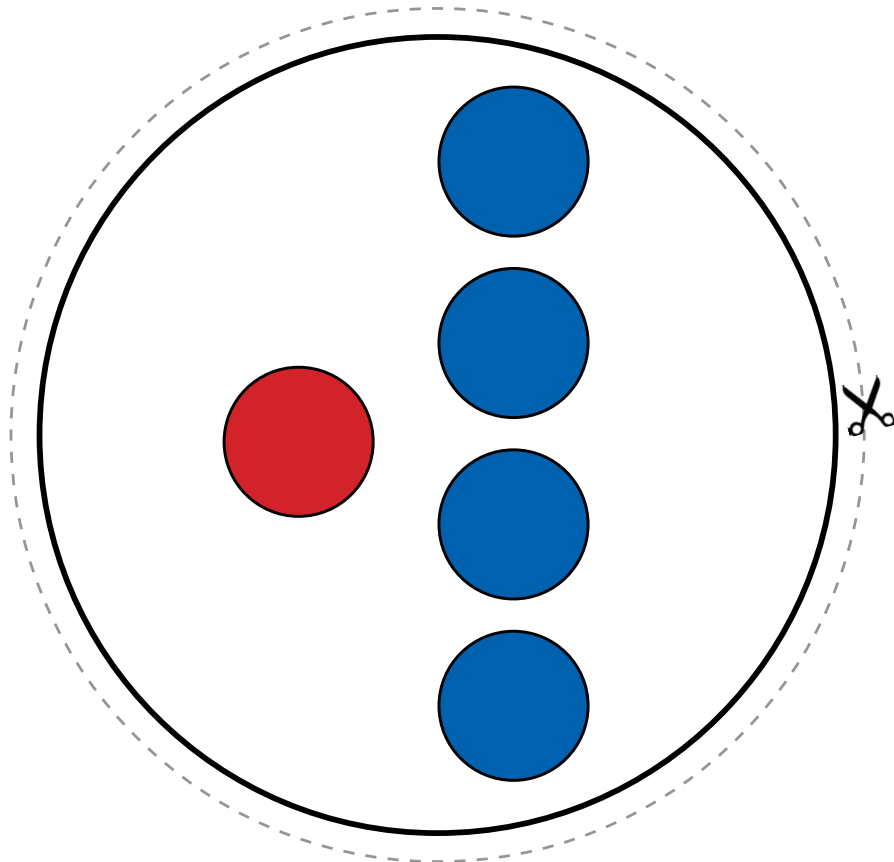
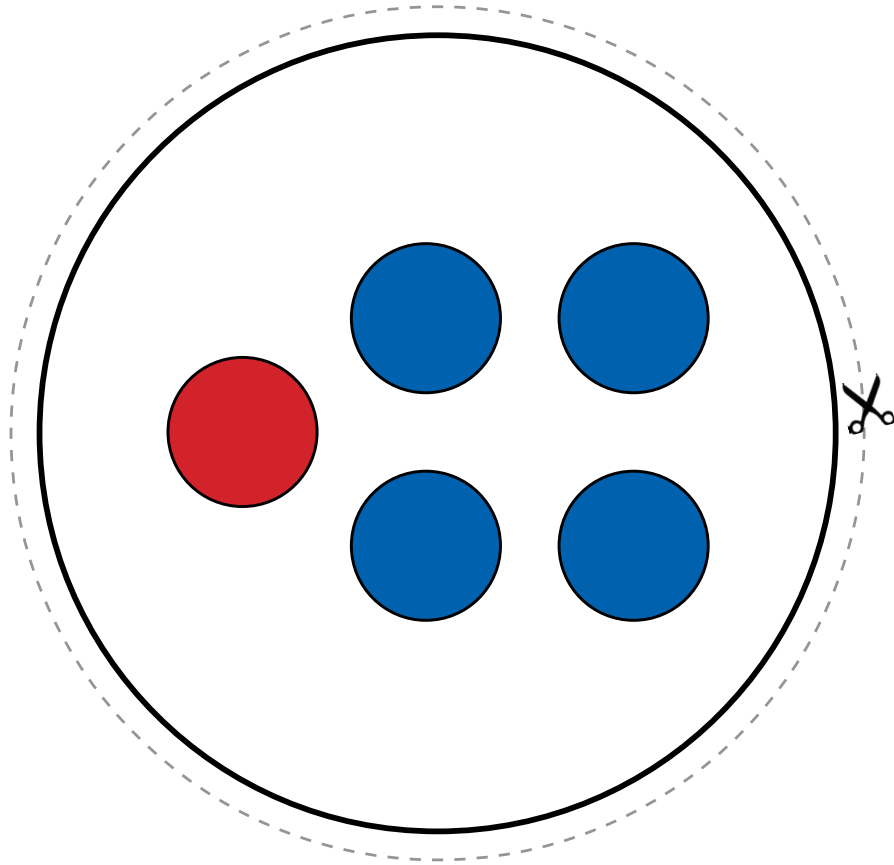

Constellations de points familiers et non familiers (1 à 10)

Format circulaire (suite)

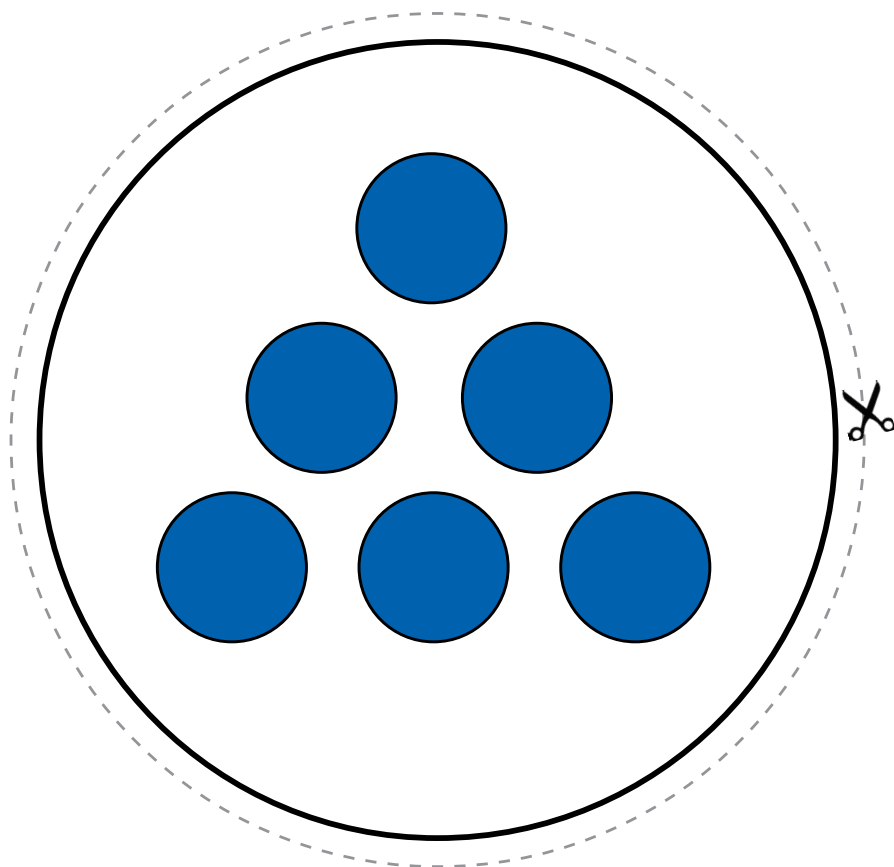
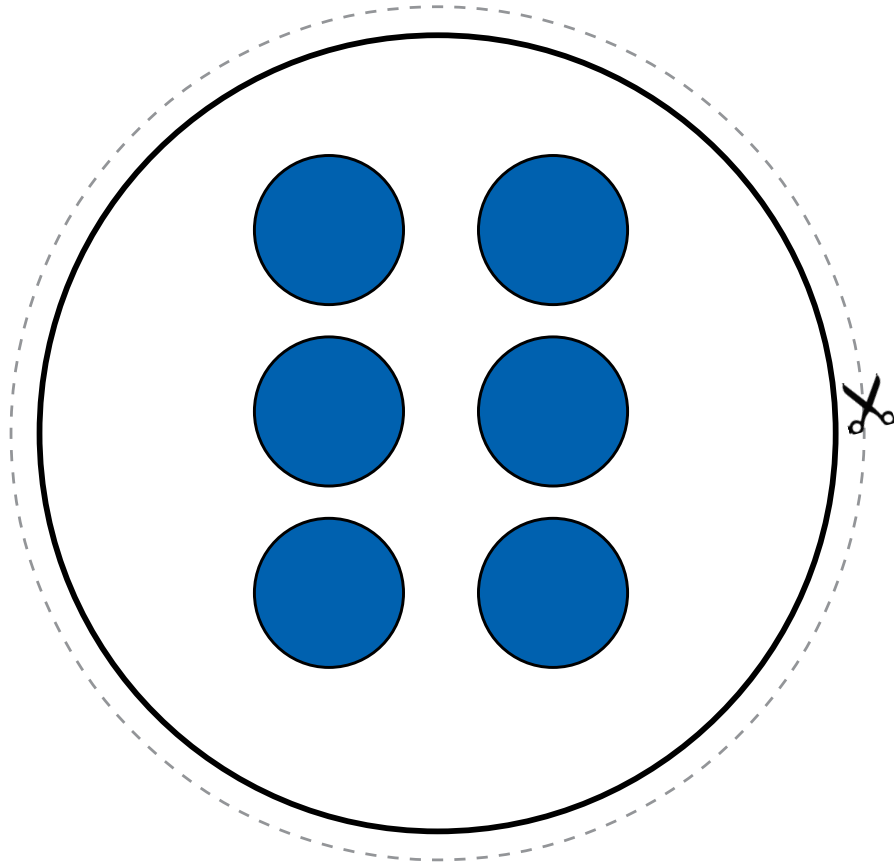

Constellations de points familiers et non familiers (1 à 10)

Format circulaire (suite)

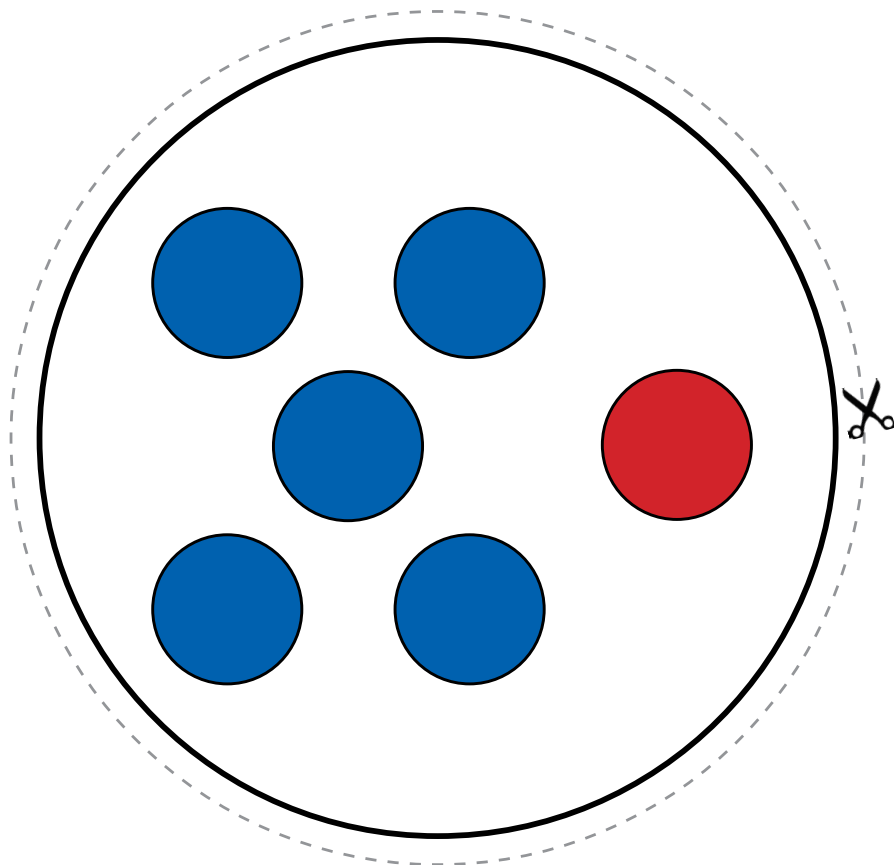
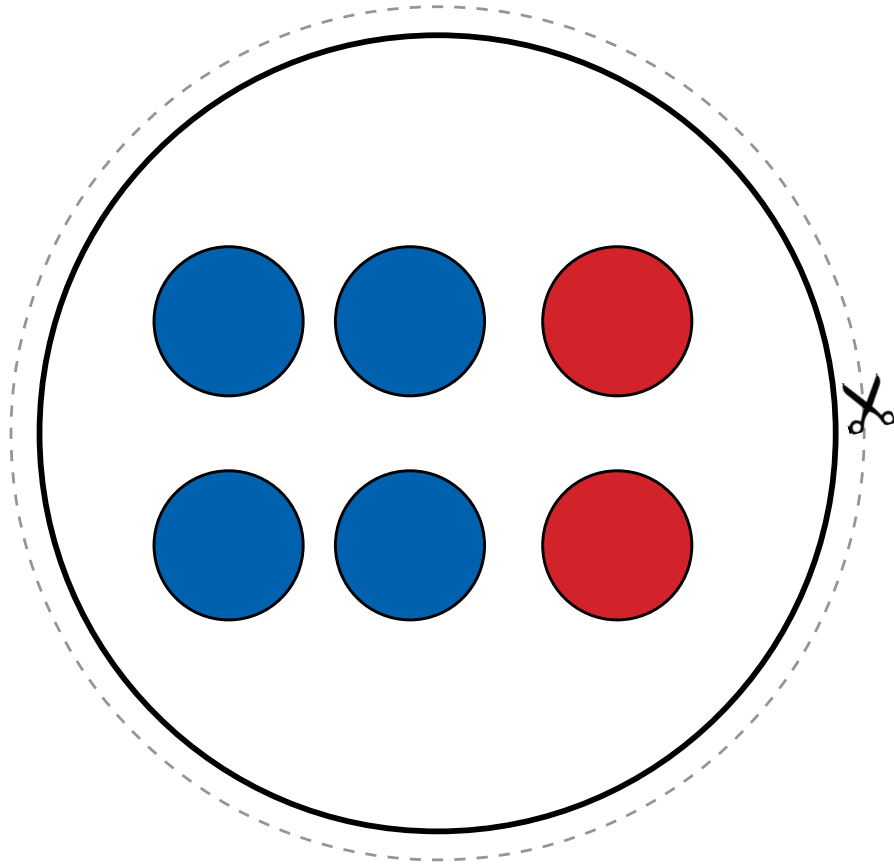

Constellations de points familiers et non familiers (1 à 10)

Format circulaire (suite)

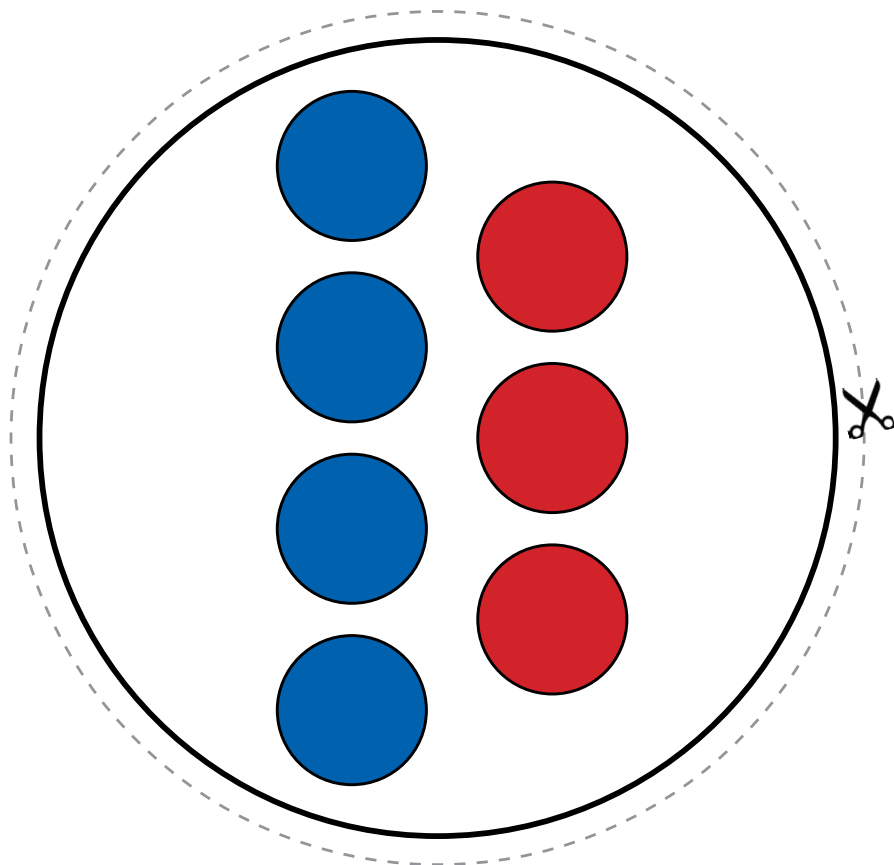
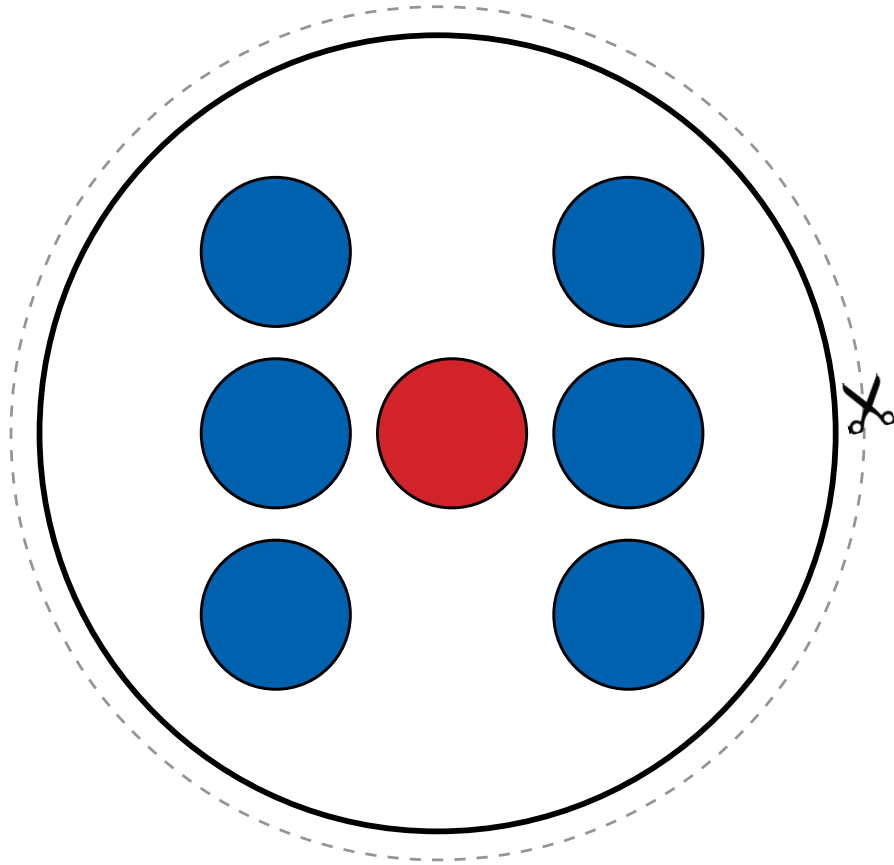

Constellations de points familiers et non familiers (1 à 10)

Format circulaire (suite)

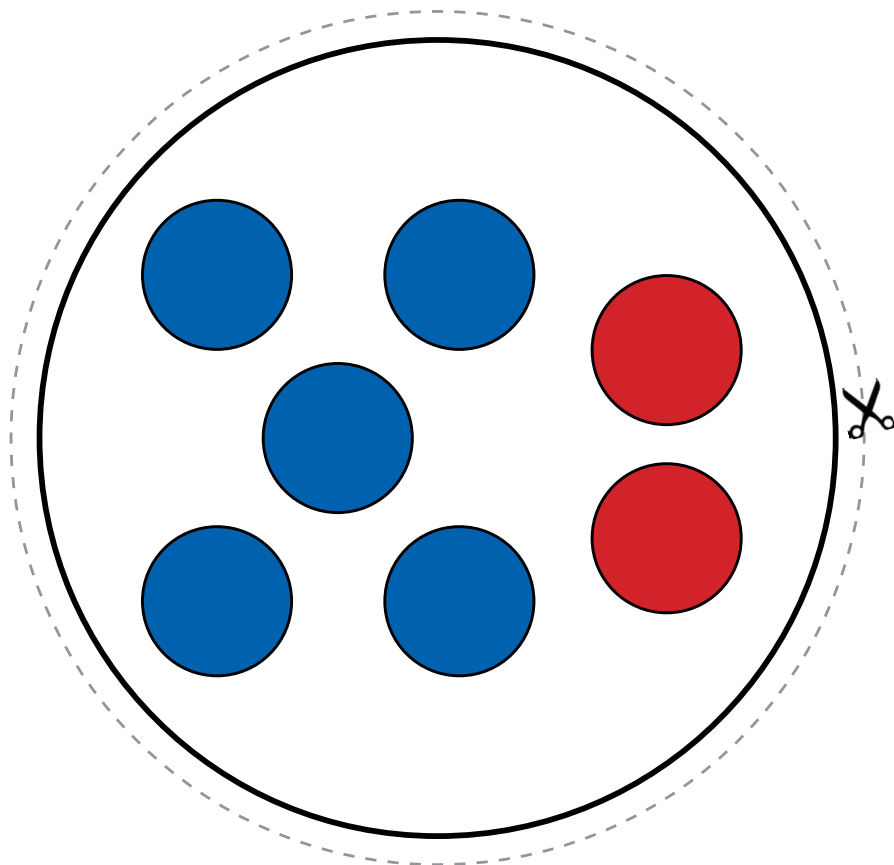
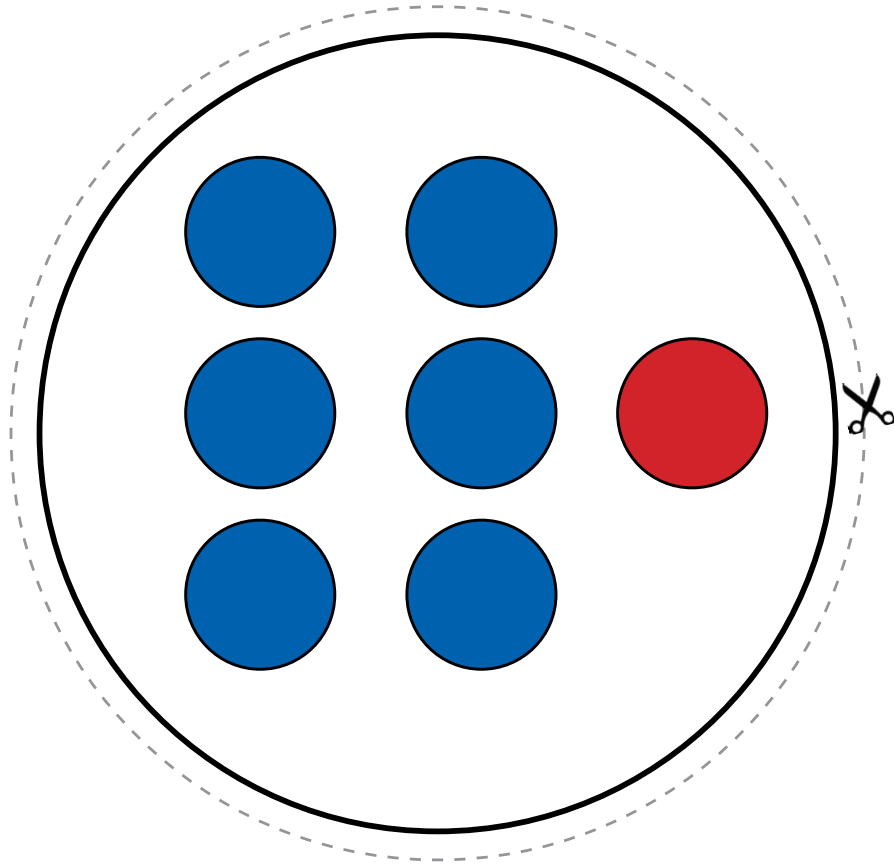

Constellations de points familiers et non familiers (1 à 10)

Format circulaire (suite)

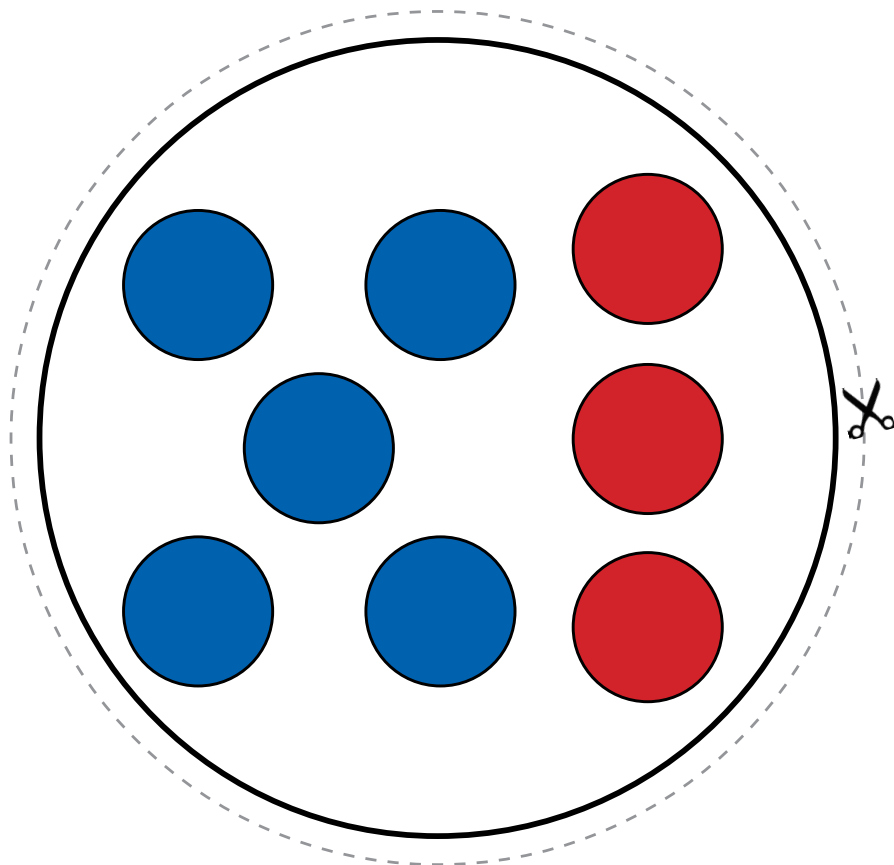
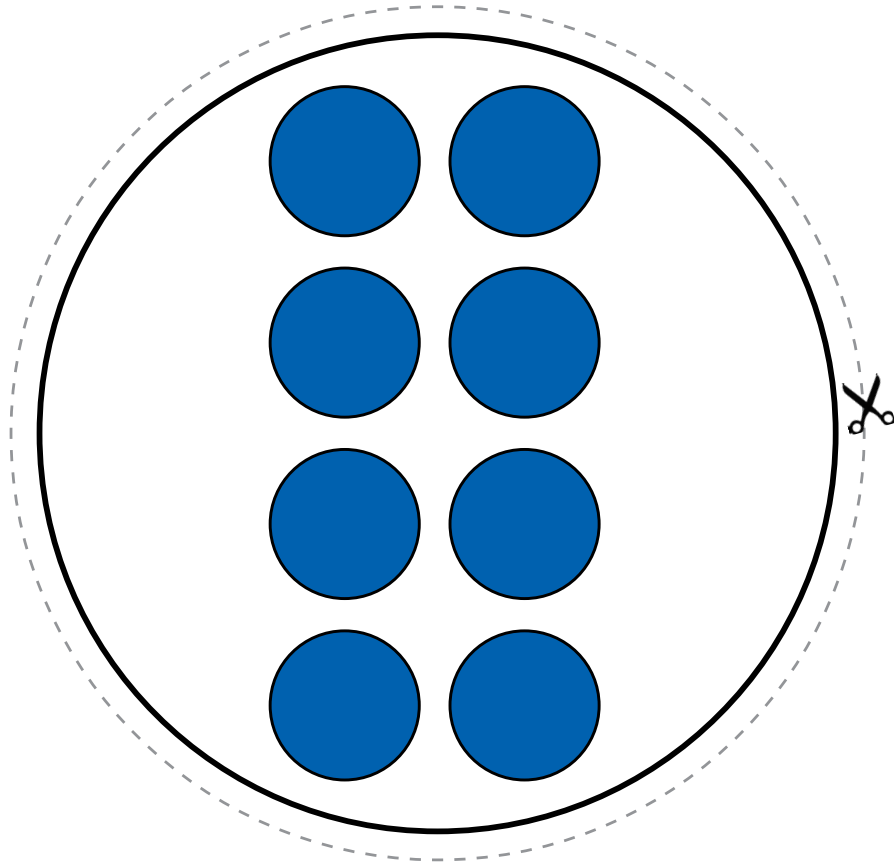

Constellations de points familiers et non familiers (1 à 10)

Format circulaire (suite)

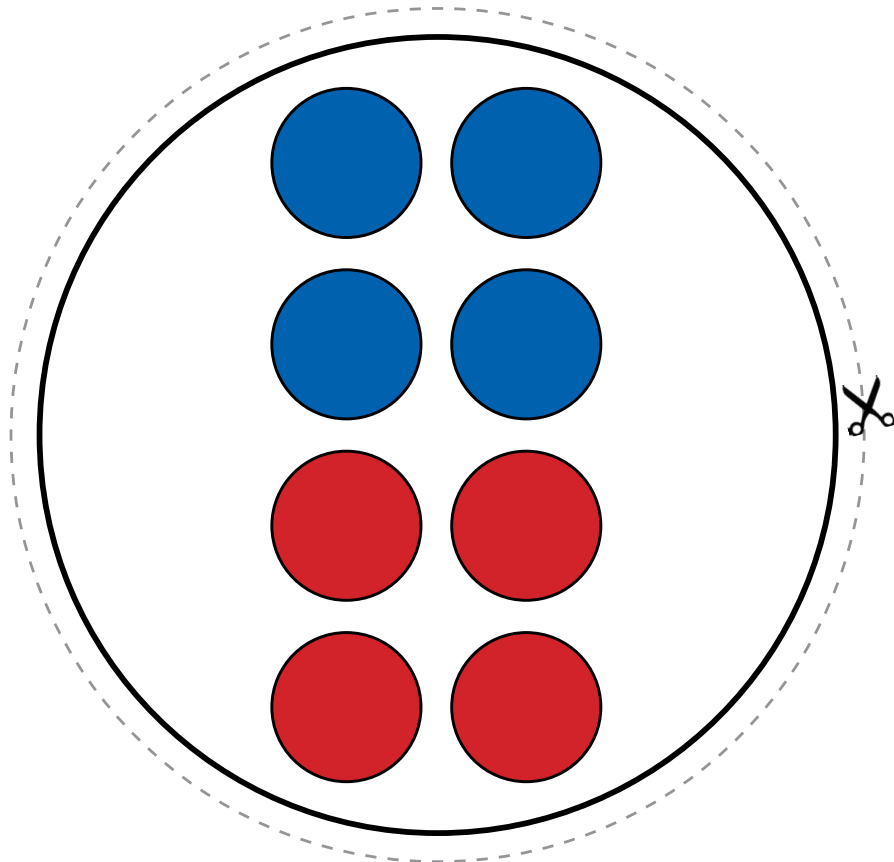
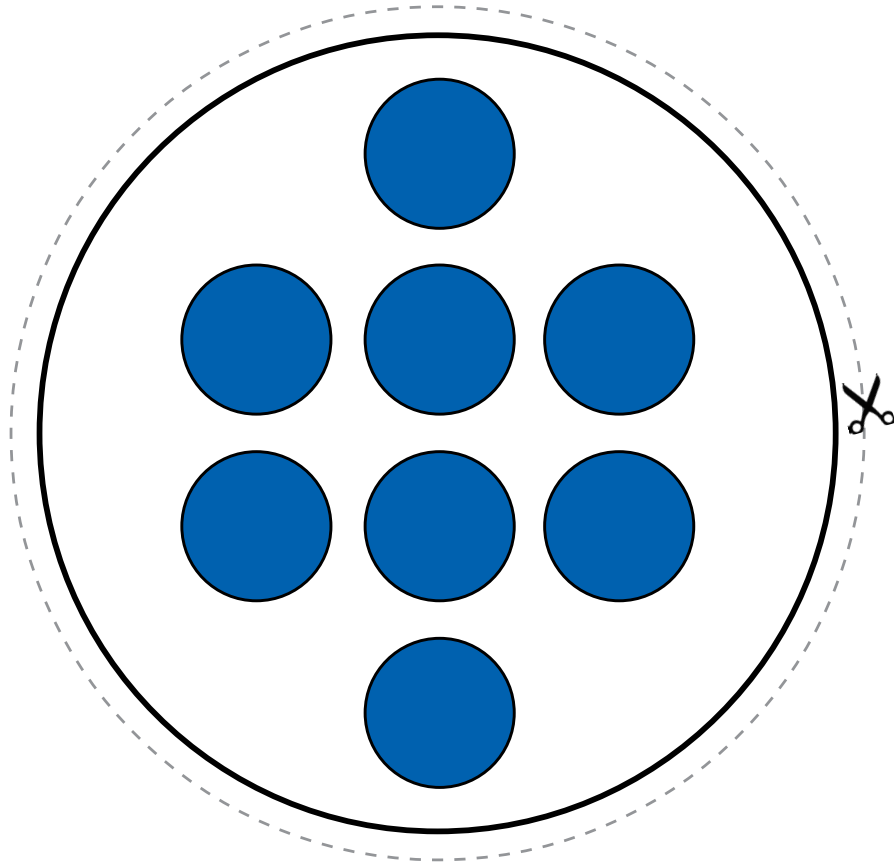

Constellations de points familiers et non familiers (1 à 10)

Format circulaire (suite)

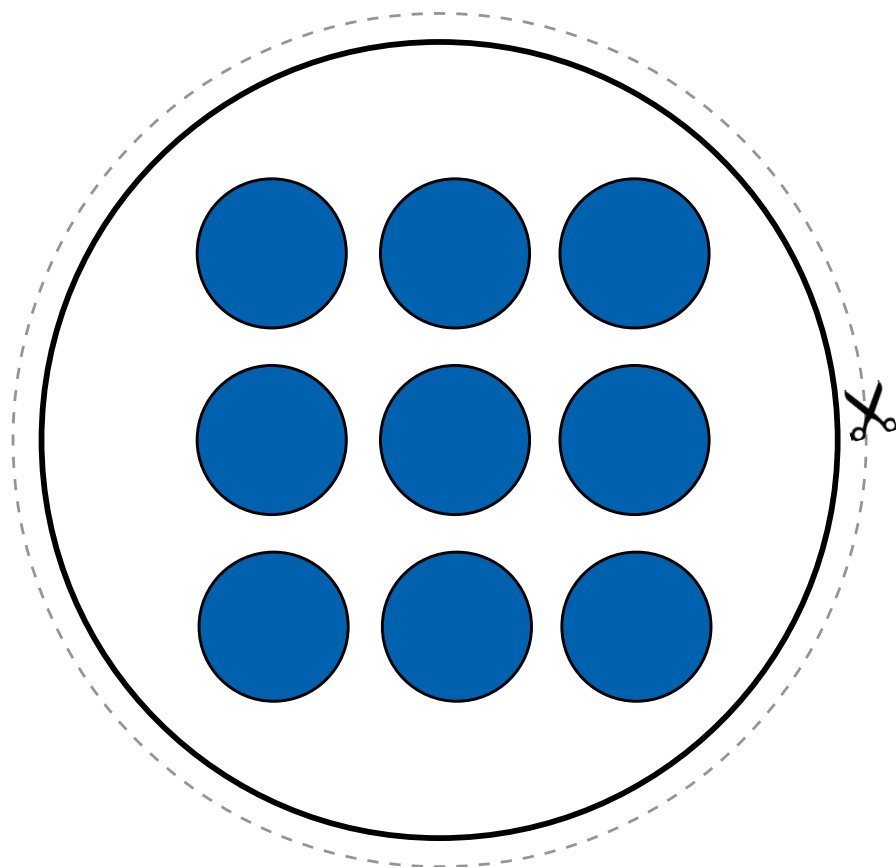
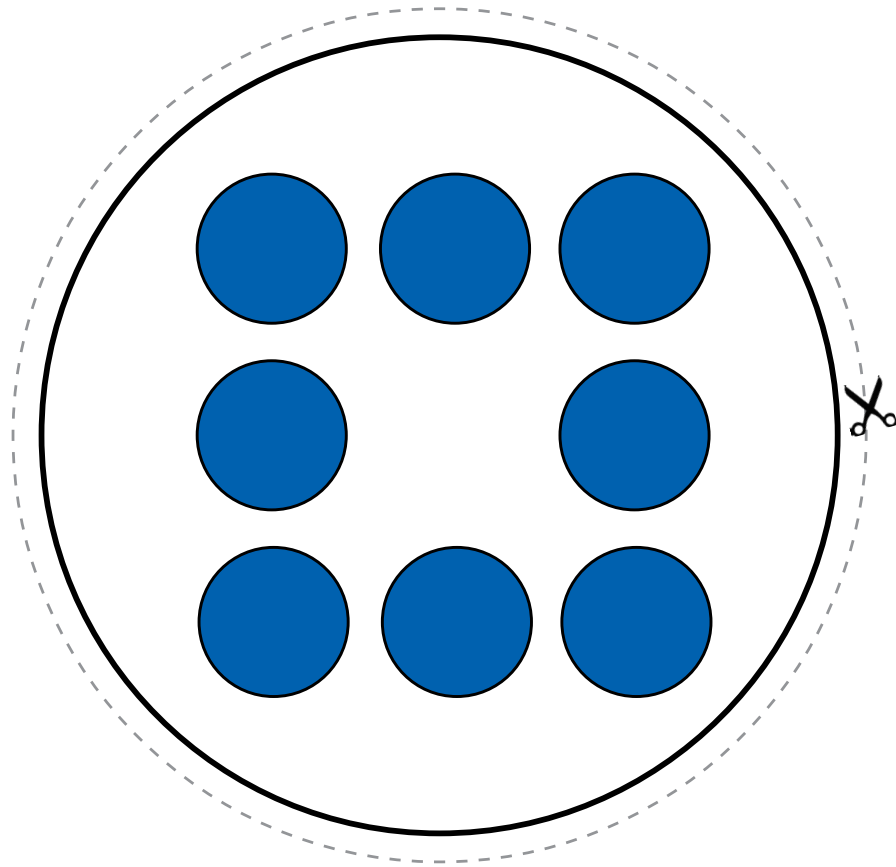

Constellations de points familiers et non familiers (1 à 10)

Format circulaire (suite)

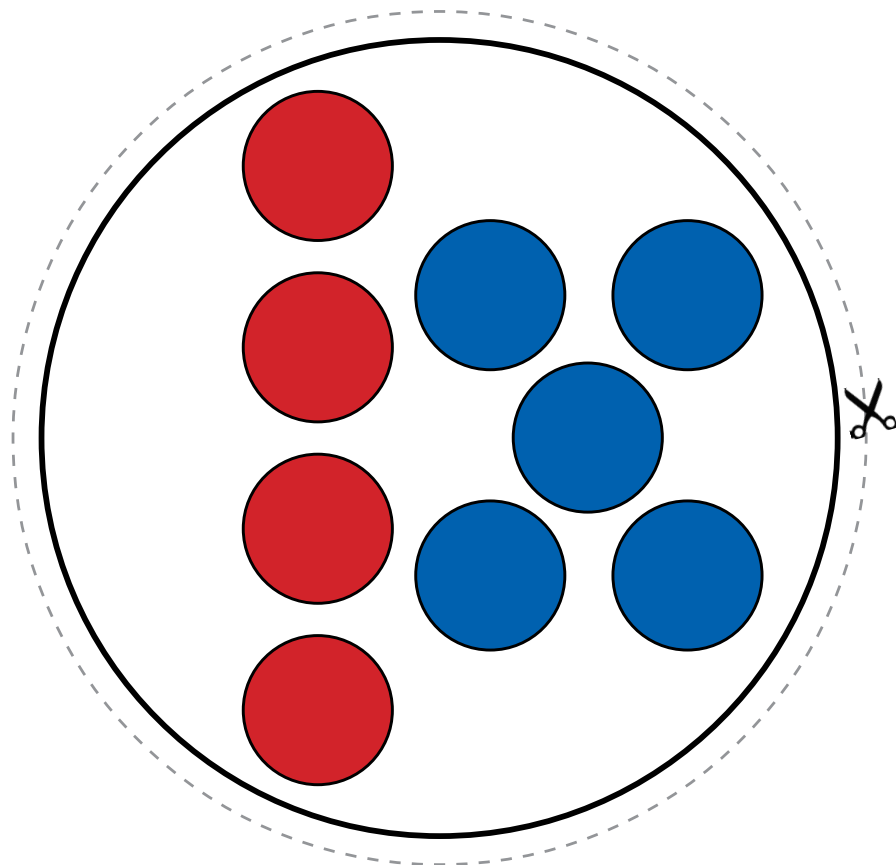
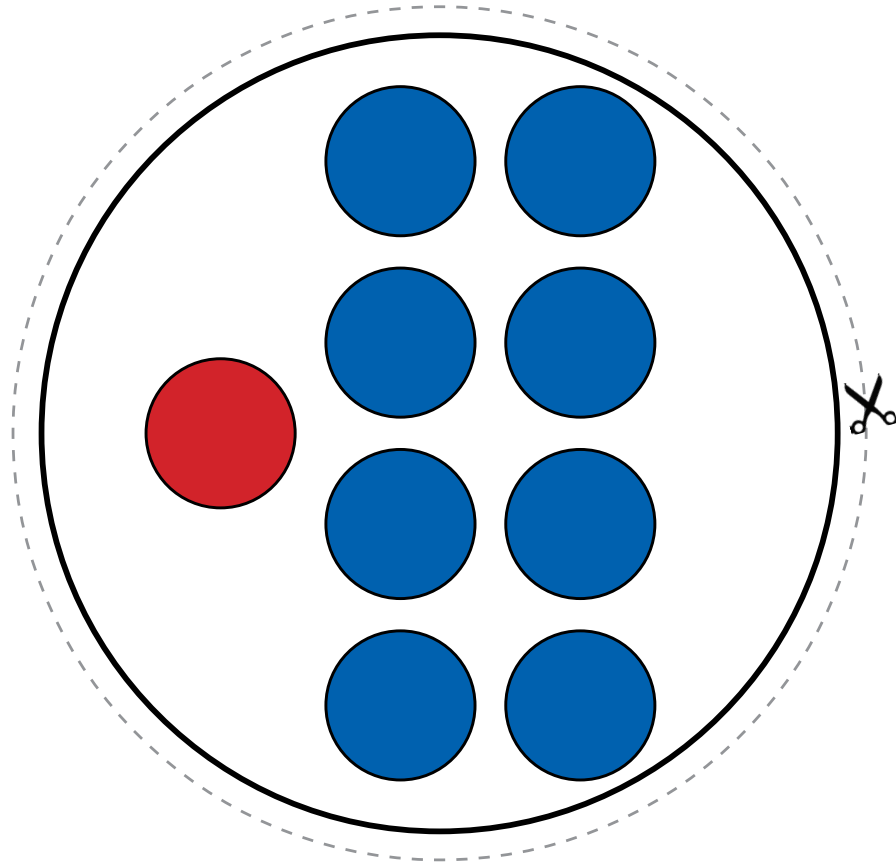

Constellations de points familiers et non familiers (1 à 10)

Format circulaire (suite)

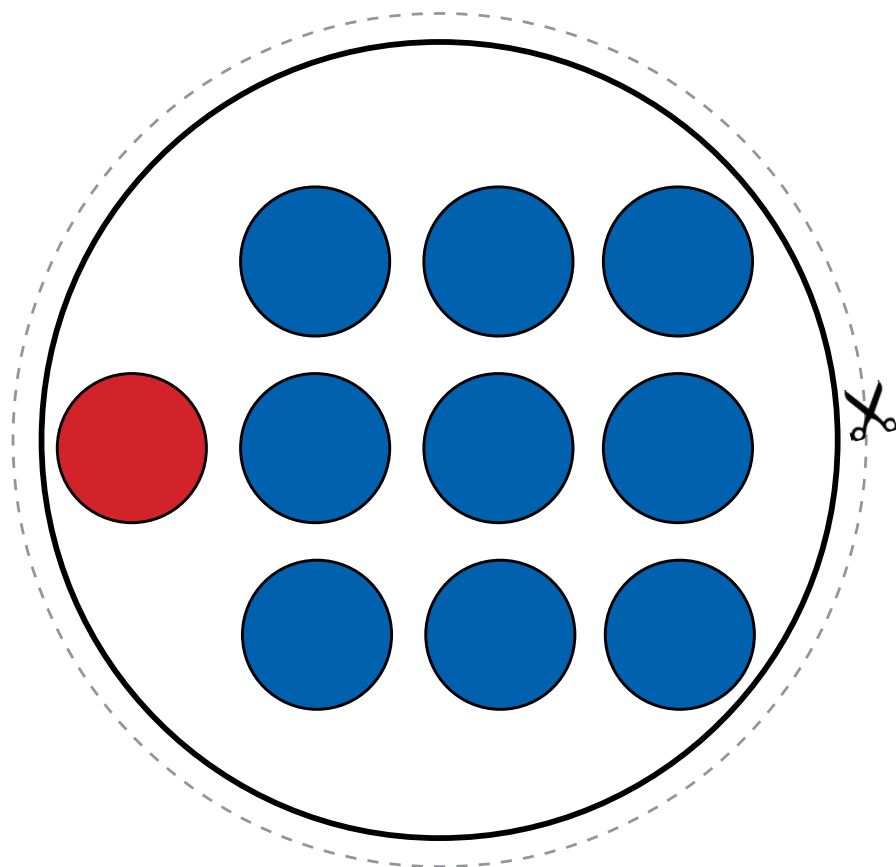
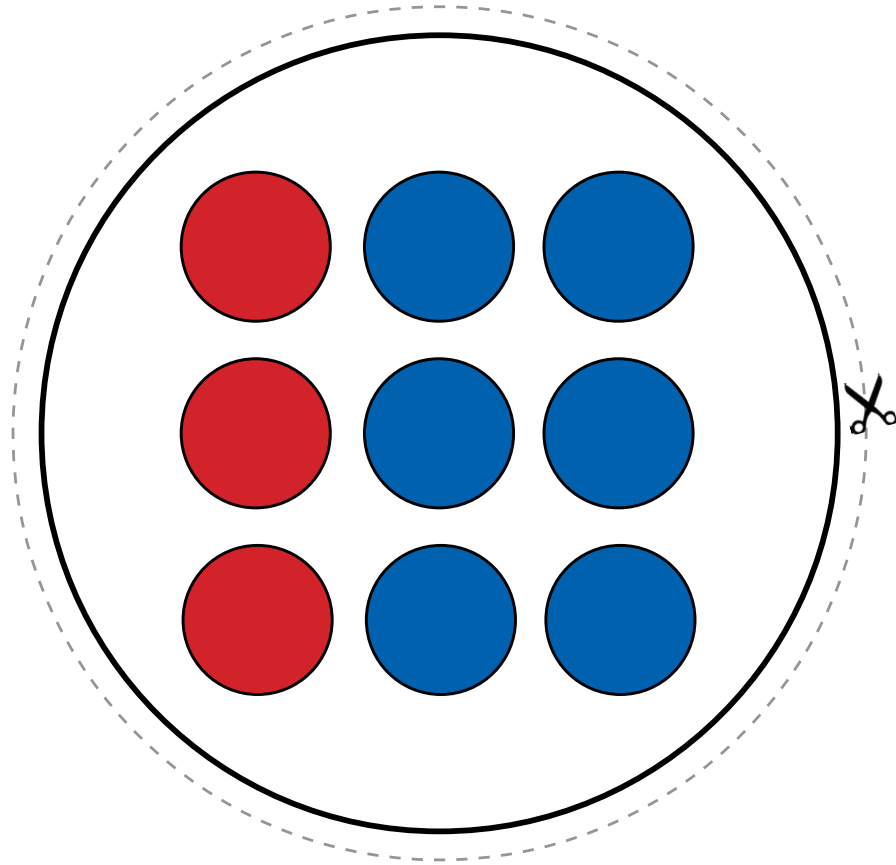

Constellations de points familiers et non familiers (1 à 10)

Format circulaire (suite)

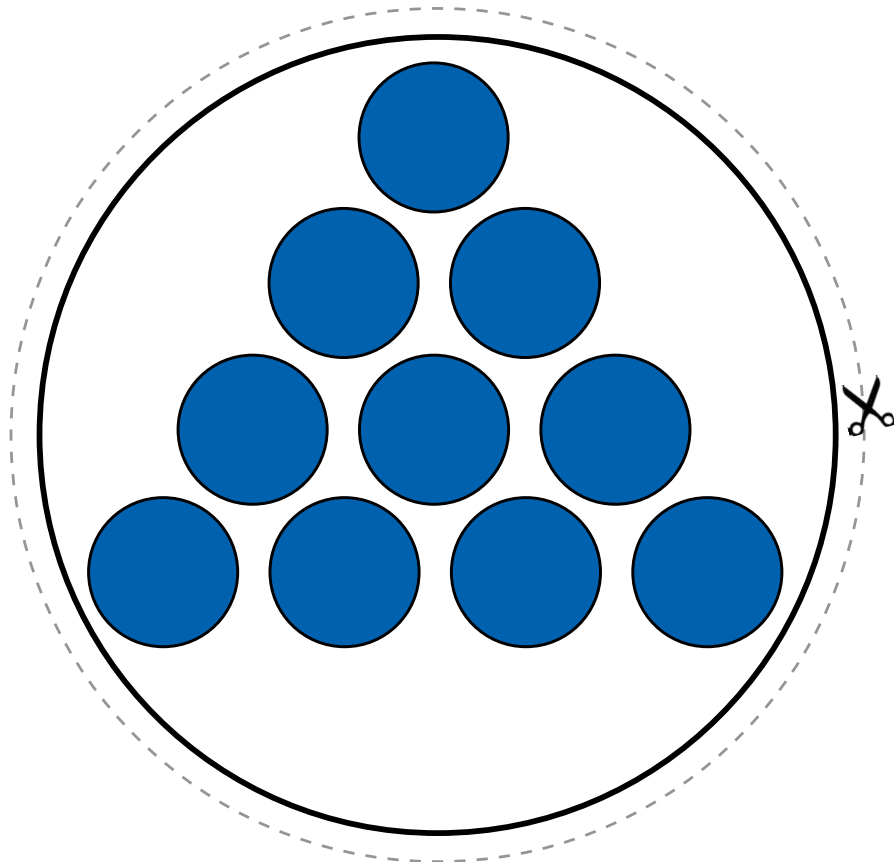
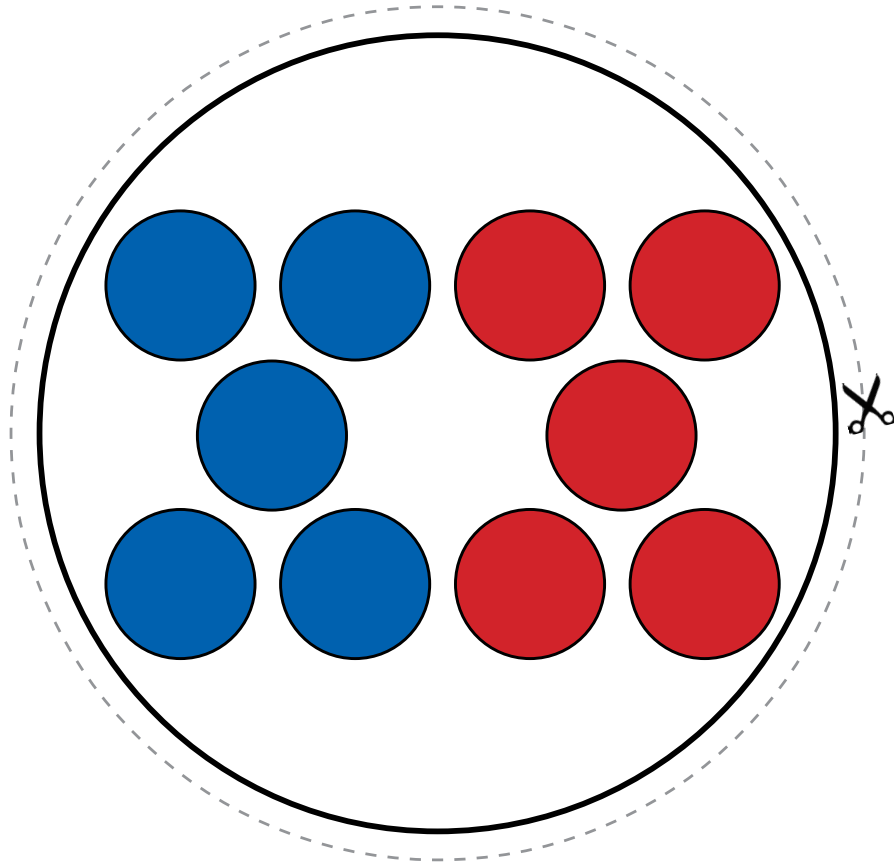

Constellations de points familiers (1 à 6)

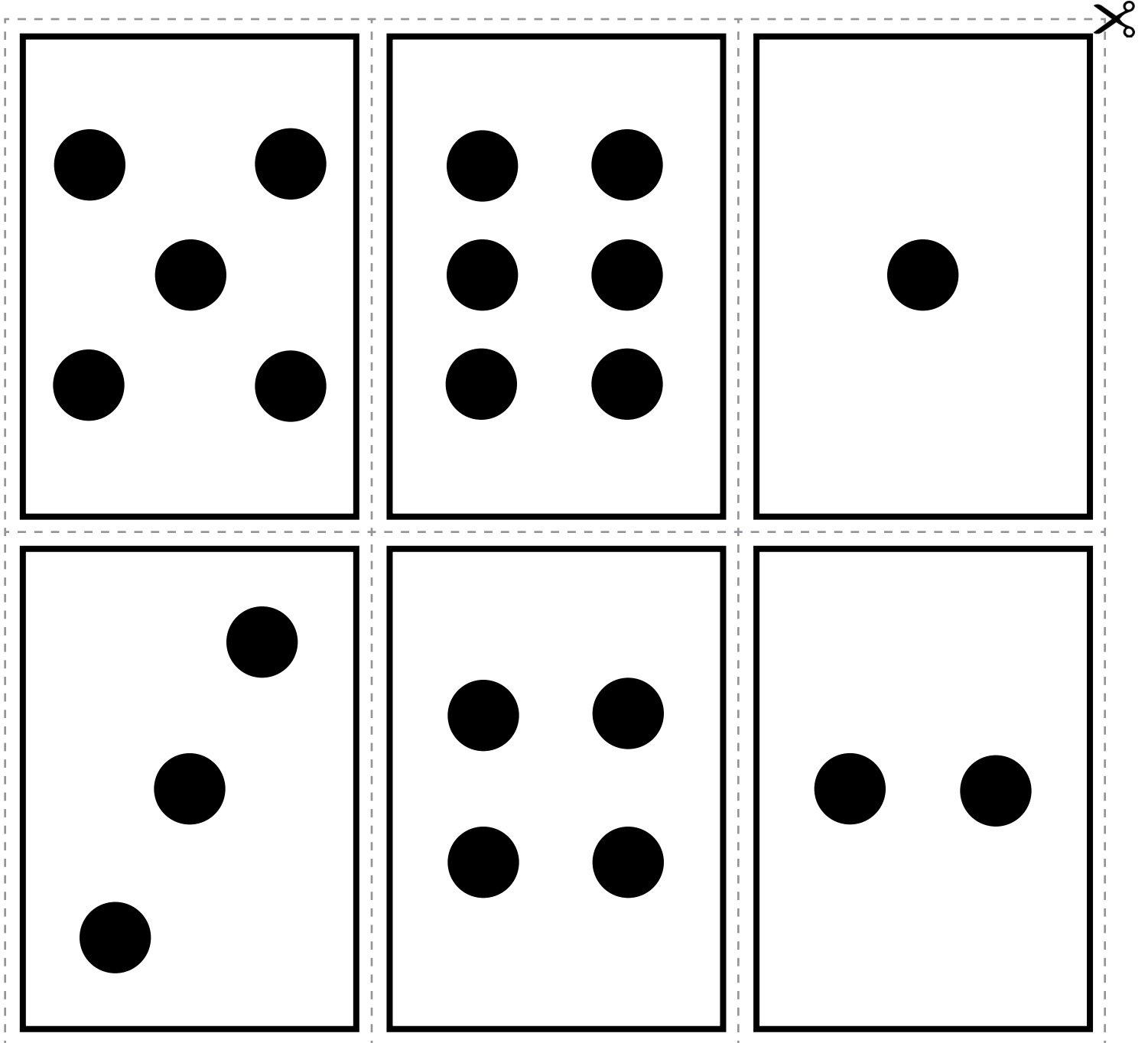

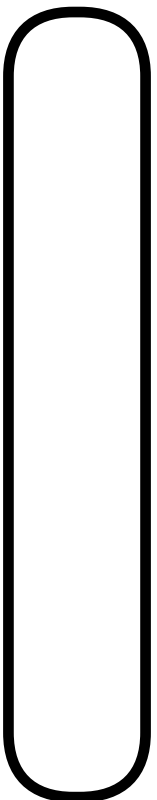

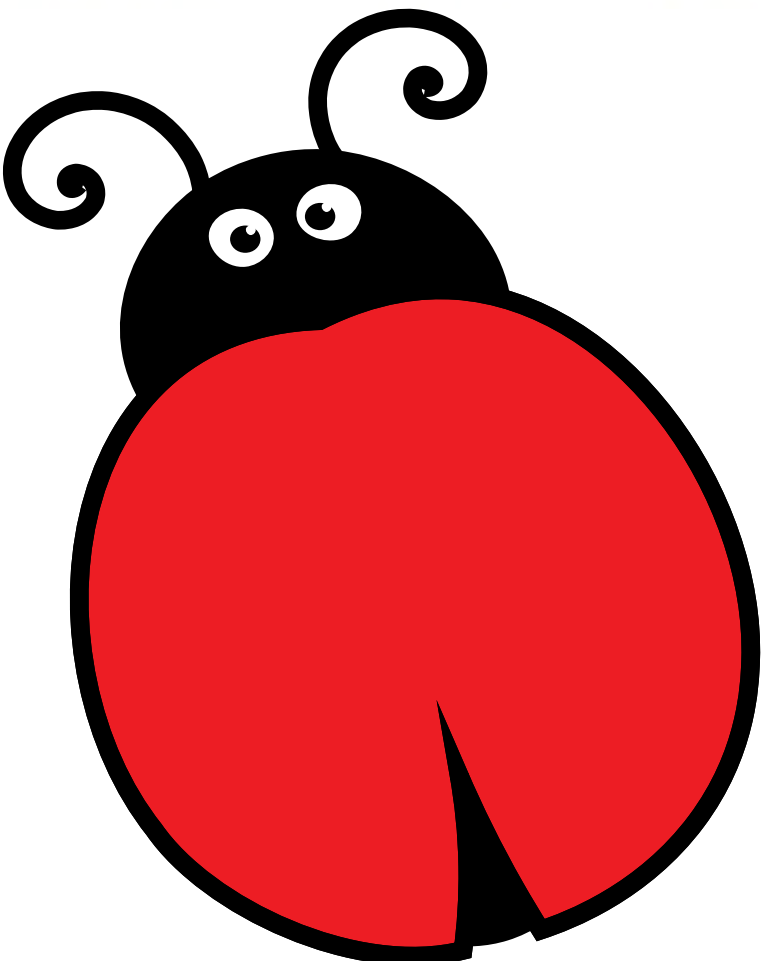

un





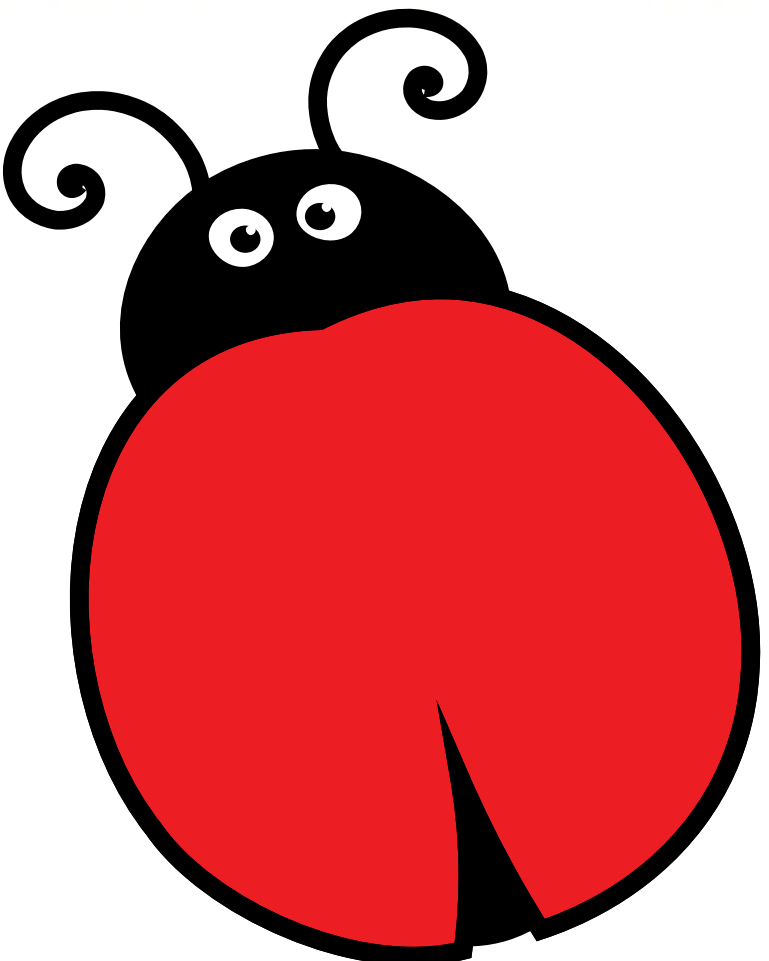

deux





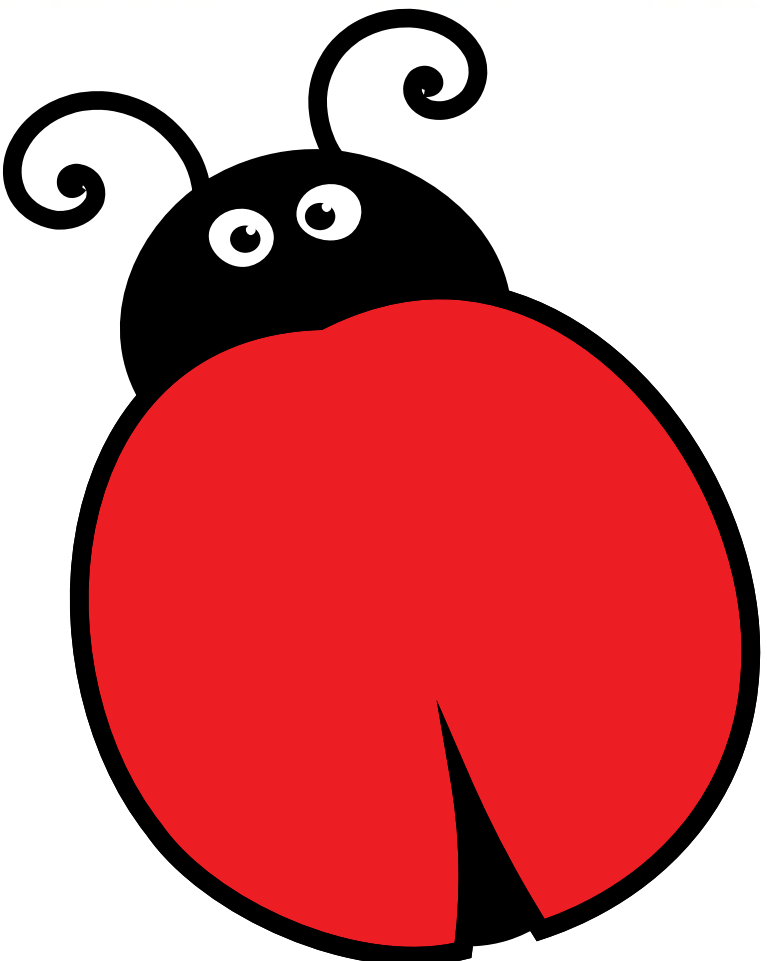

trois



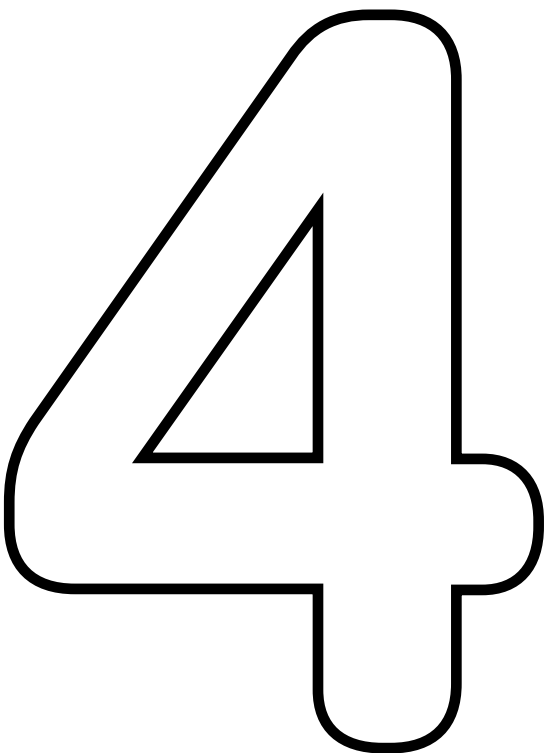

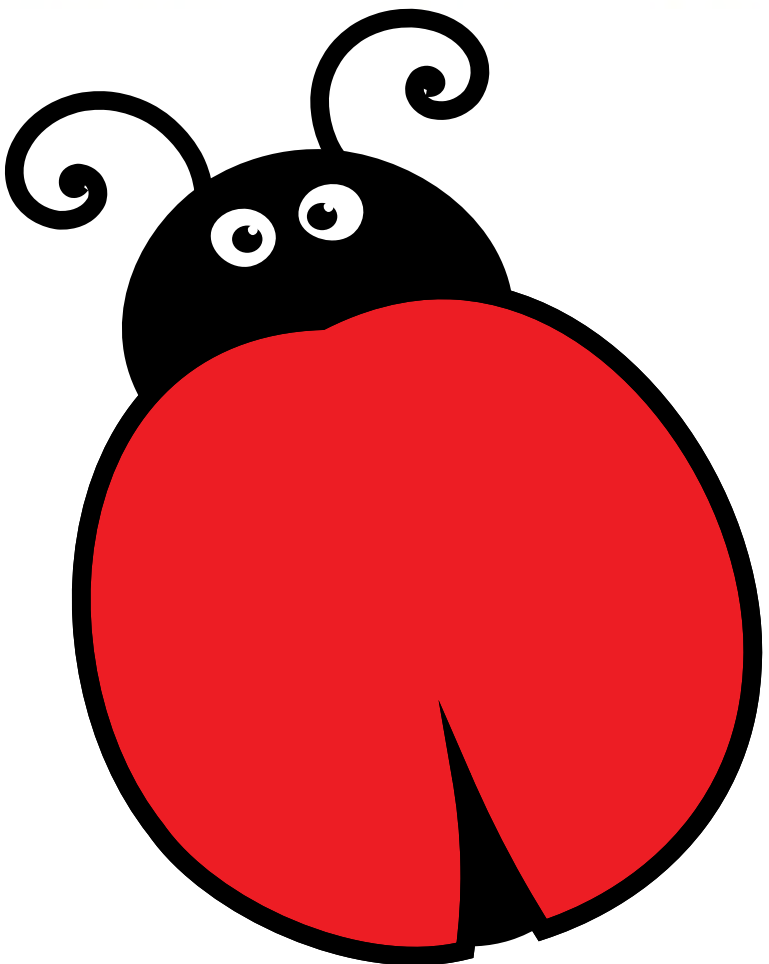
A 2x5 grid of empty rectangular boxes, intended for representing the number 4 using concrete objects or symbols.

quatre

The word "quatre" is written in a large, bold, black sans-serif font, centered below the ladybug illustration.



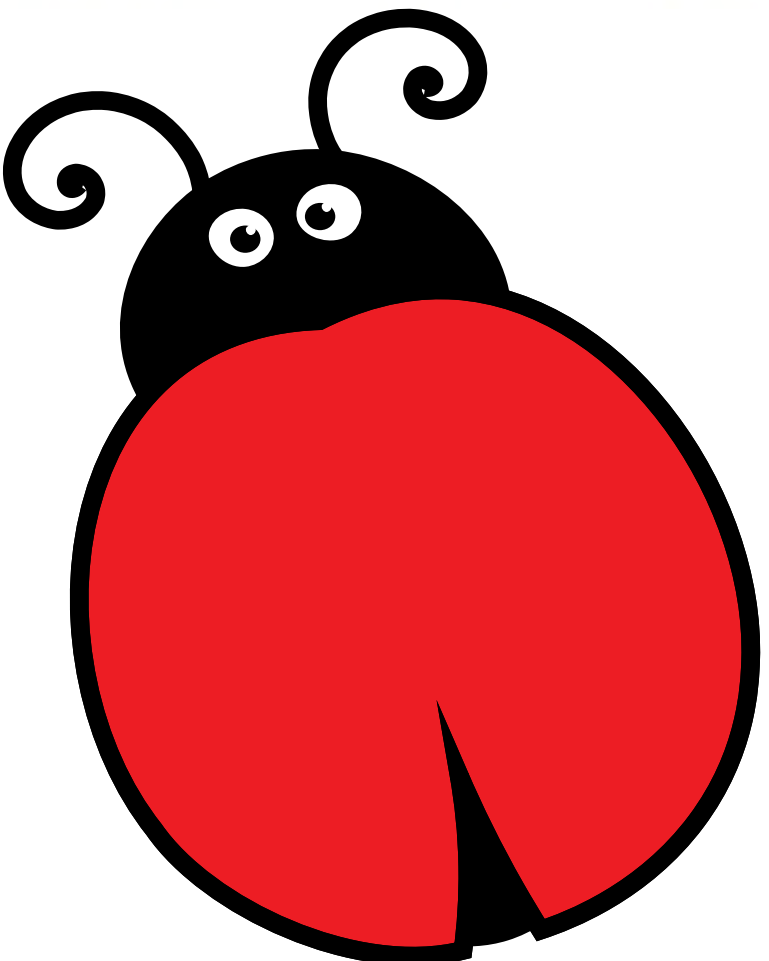

cinq



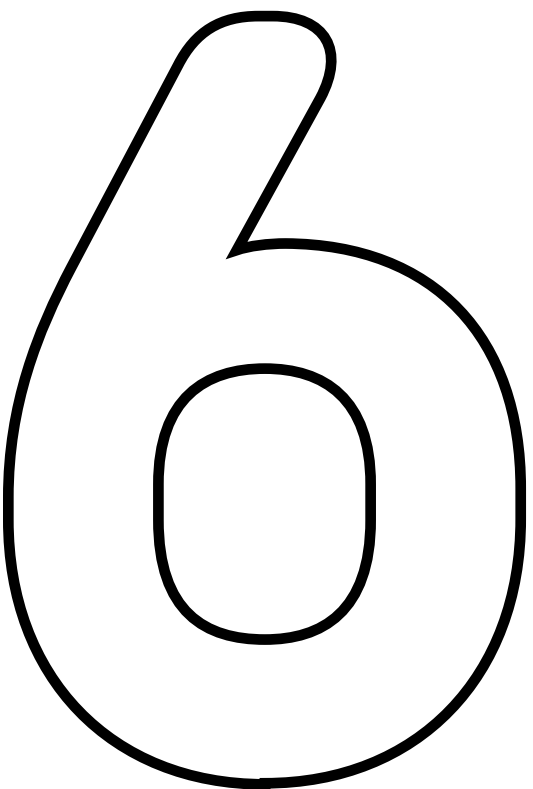

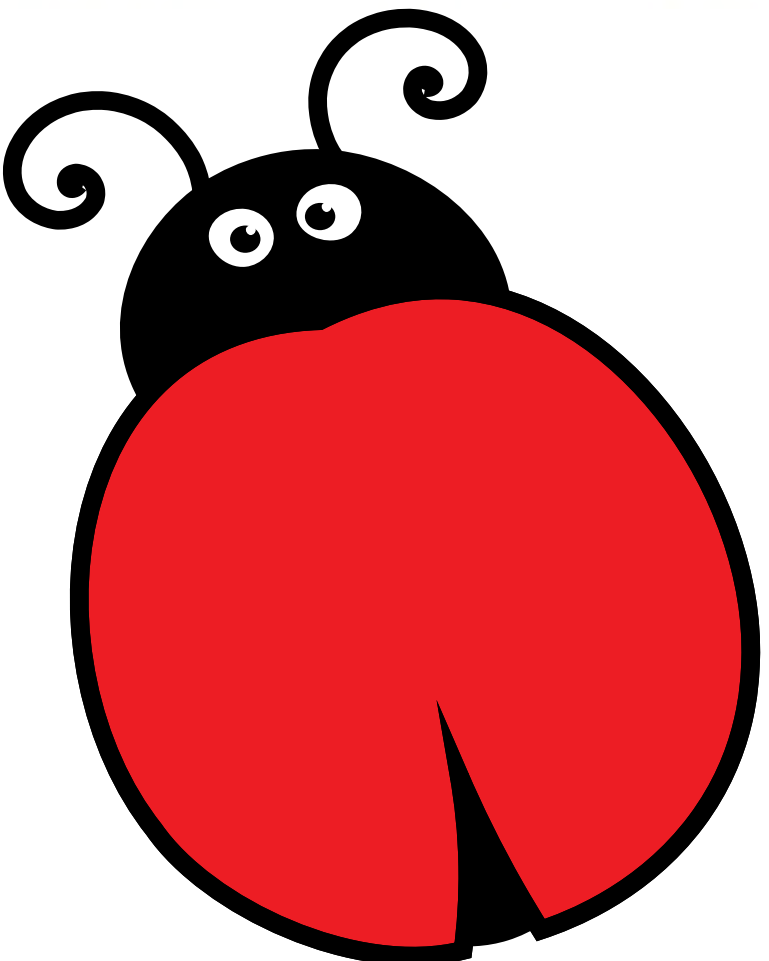

six



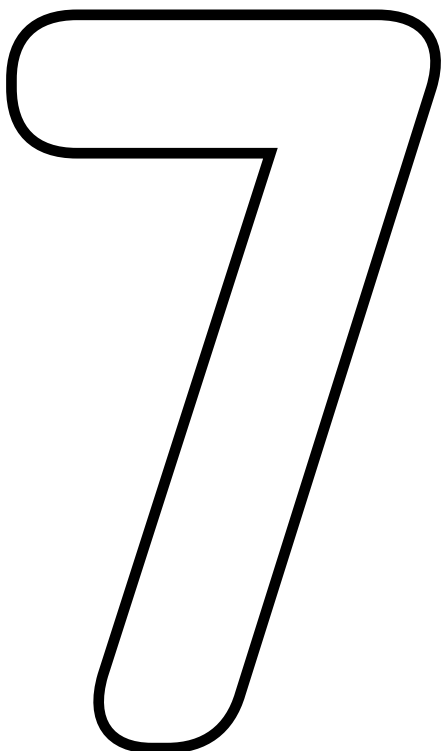

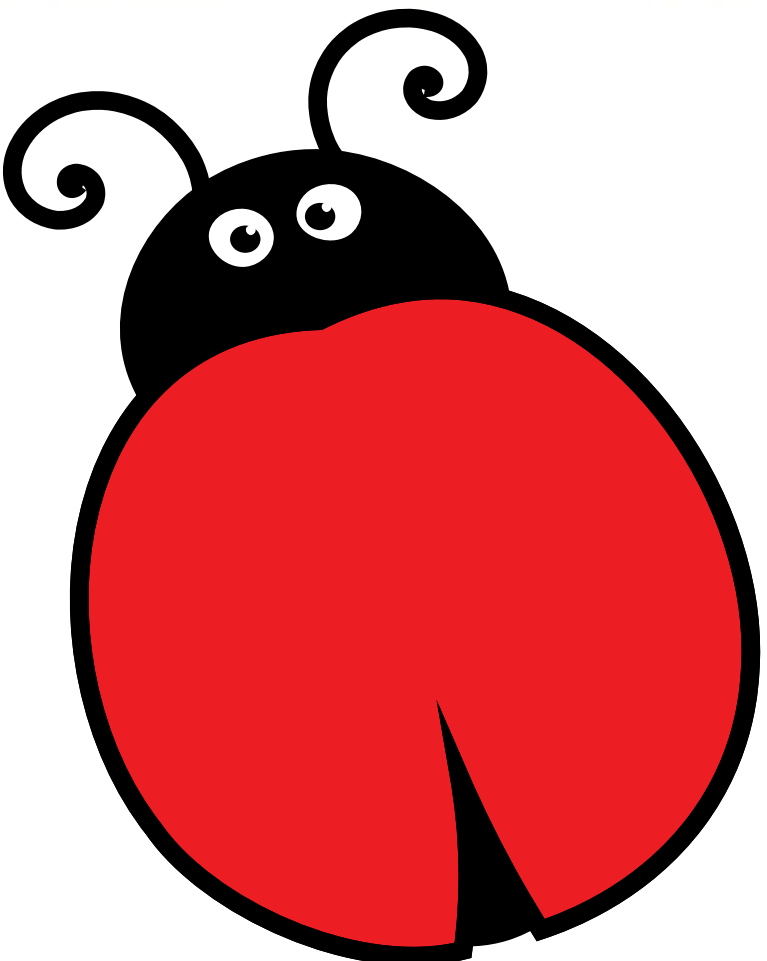

sept



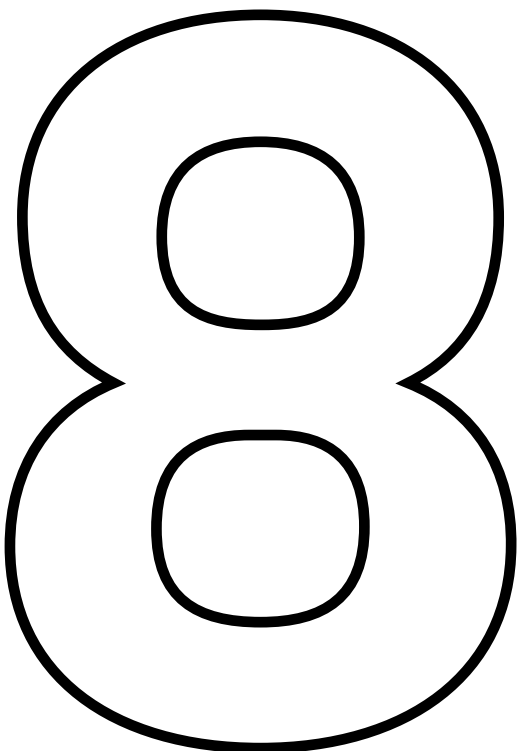

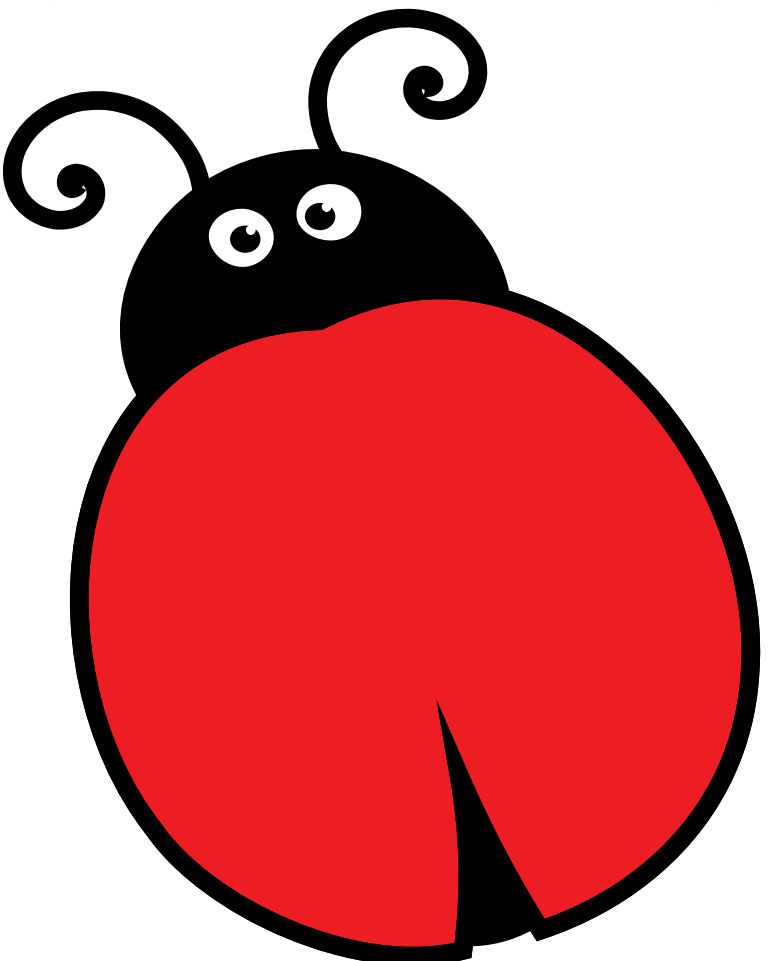

huit



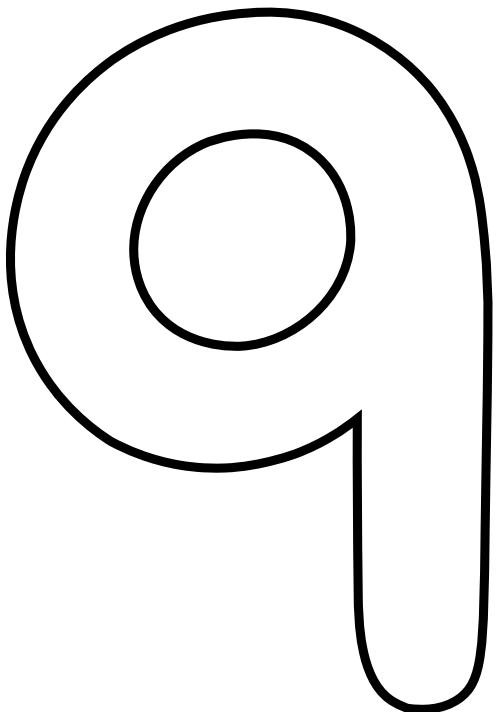

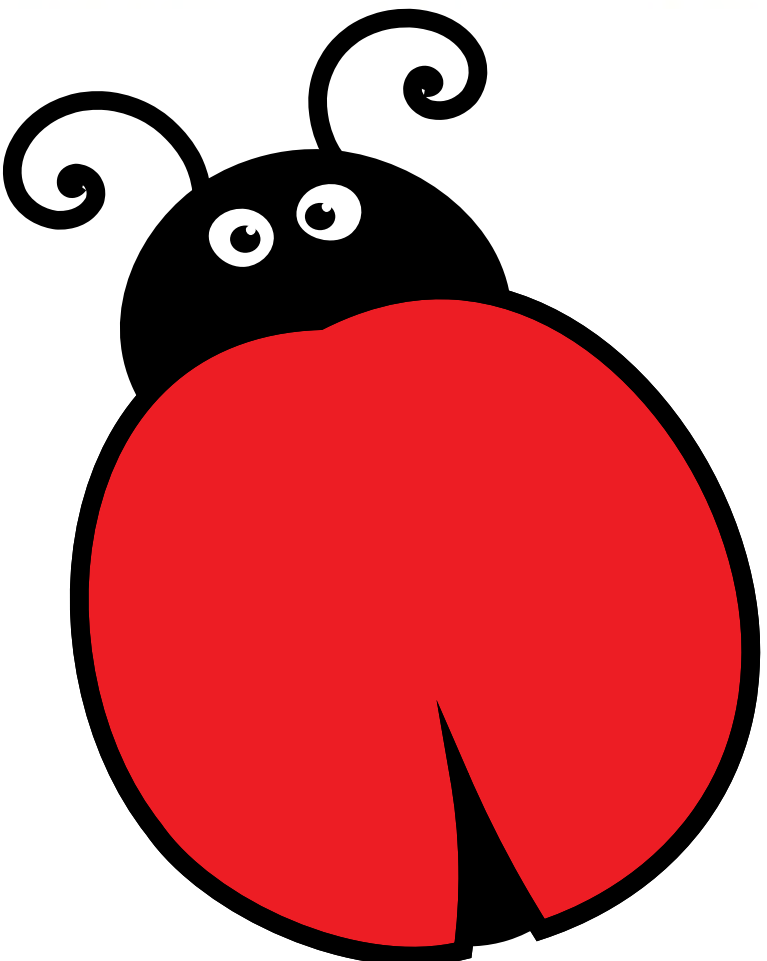

neuf



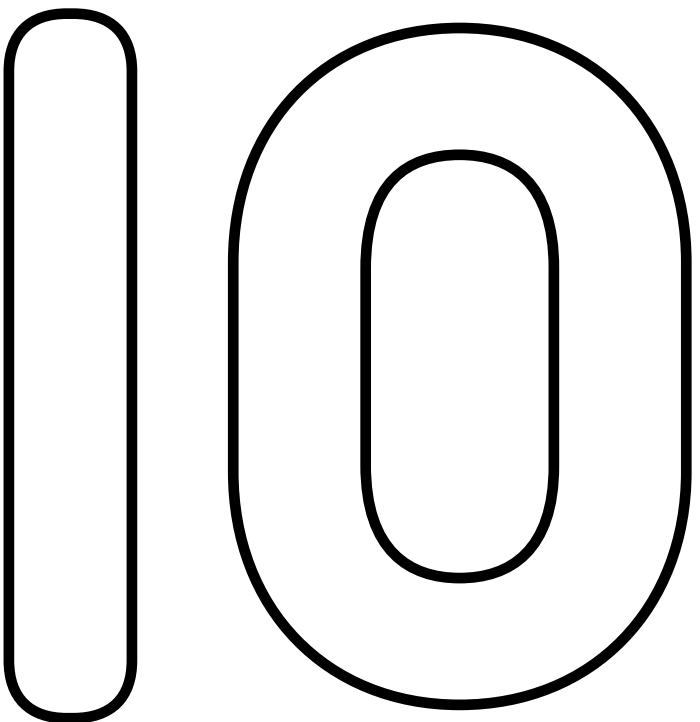

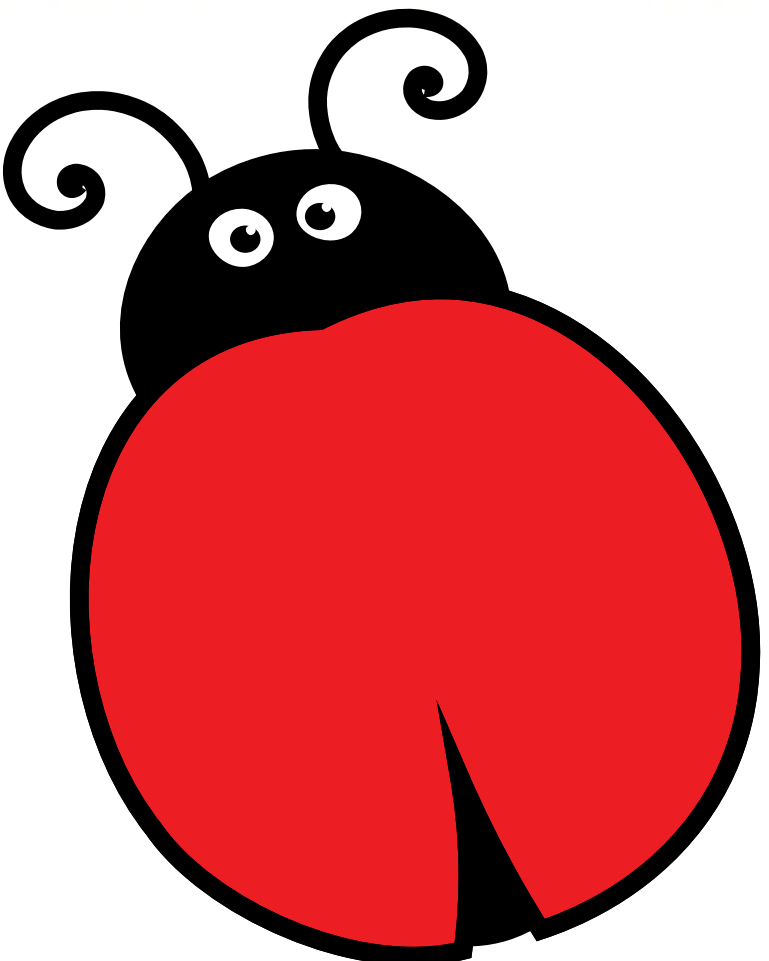

dix



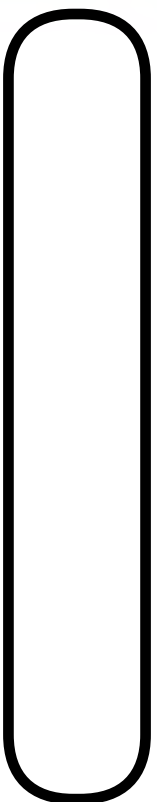

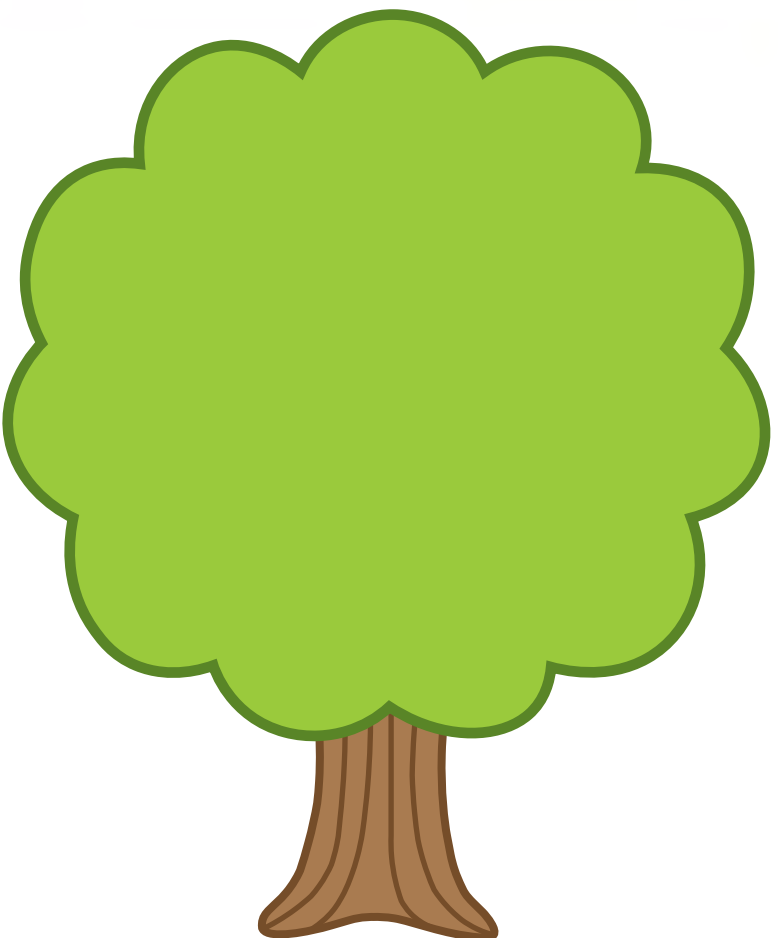

un





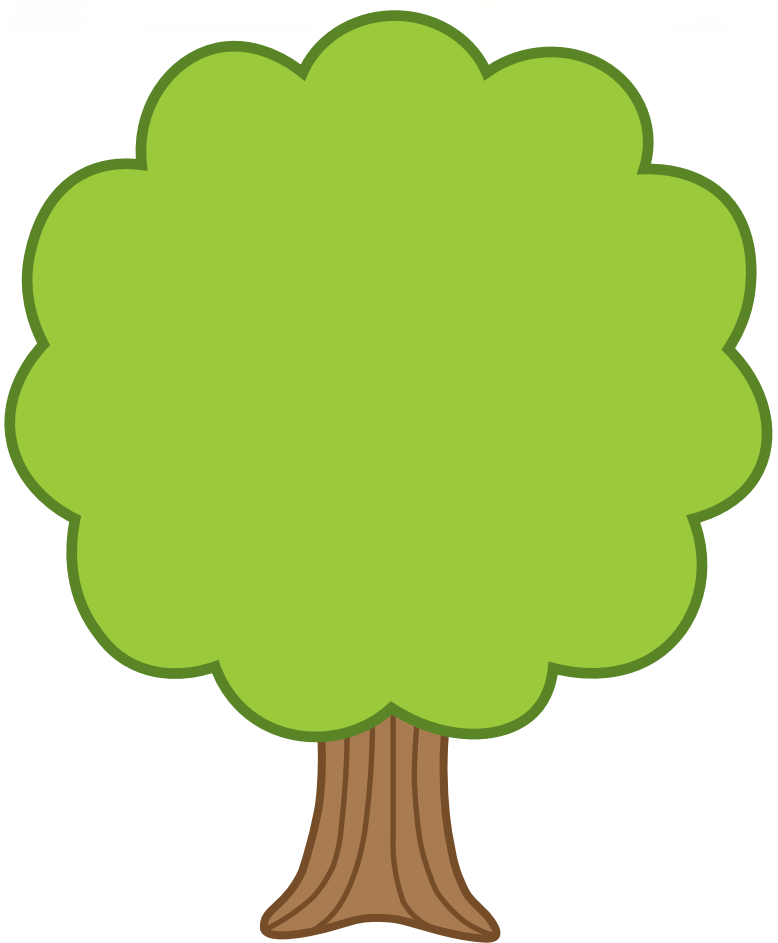

deux





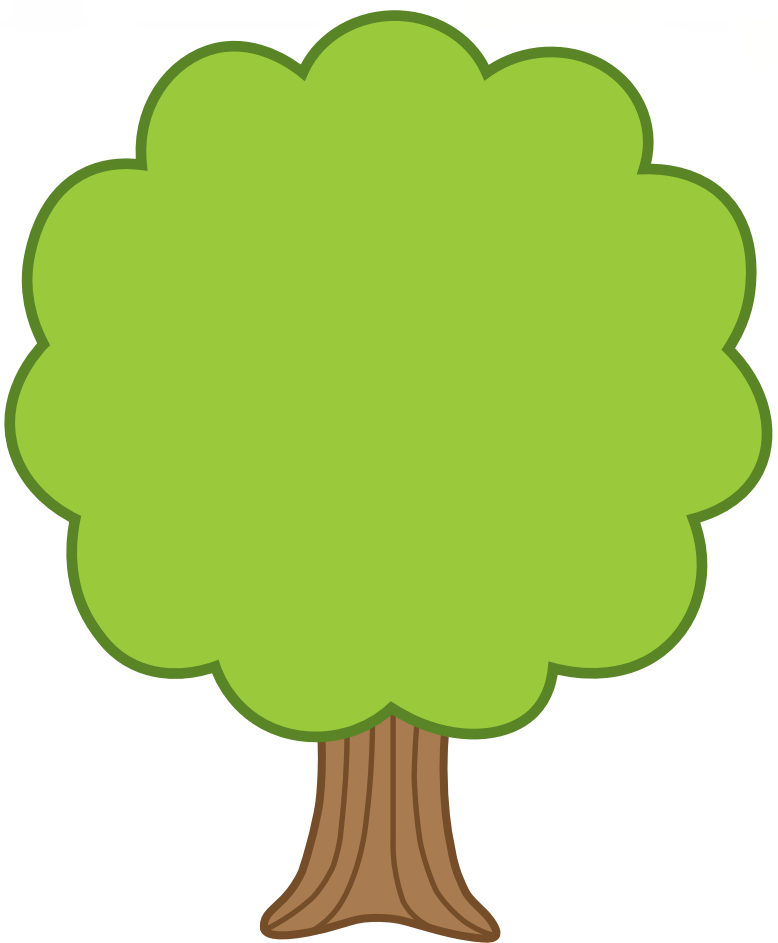

trois



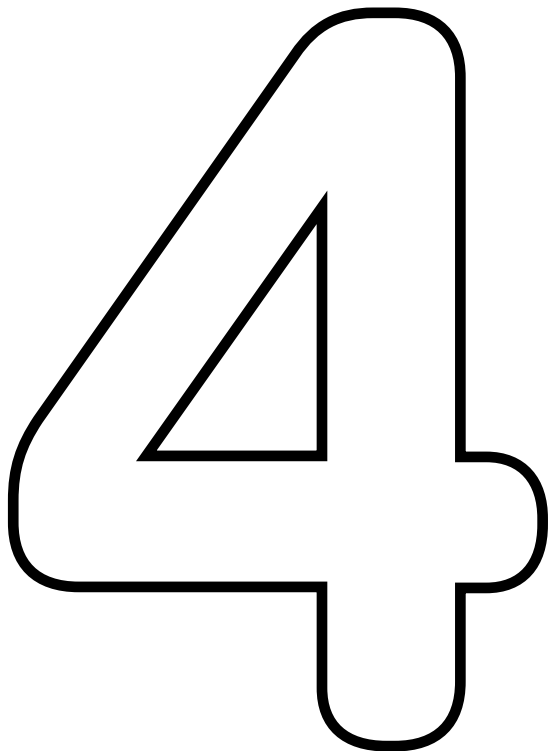

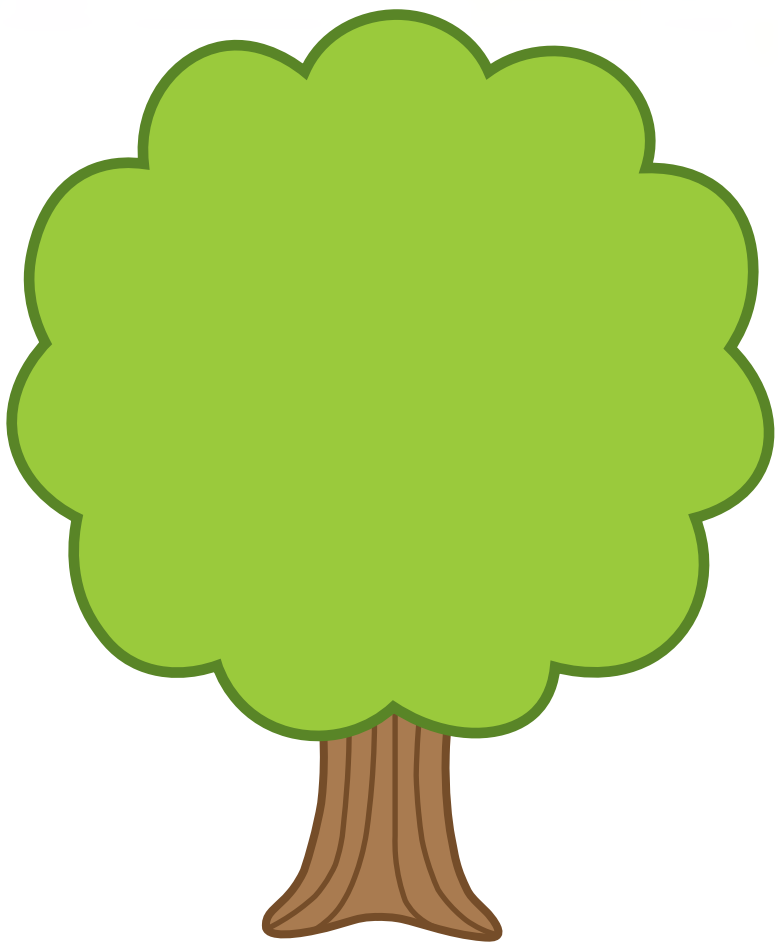

quatre



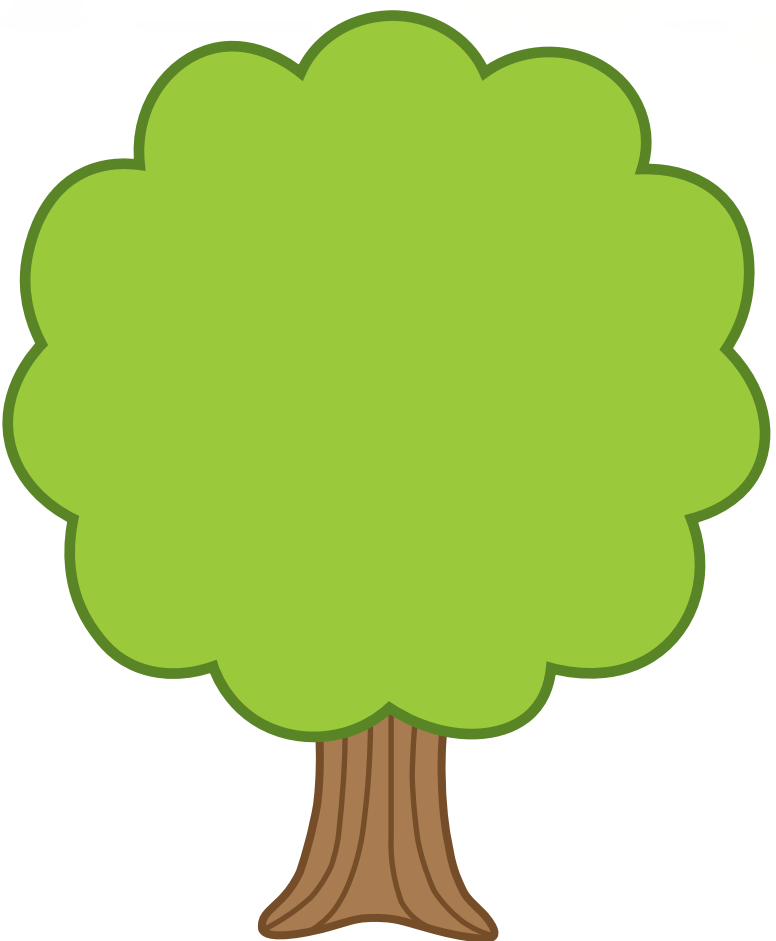

cinq





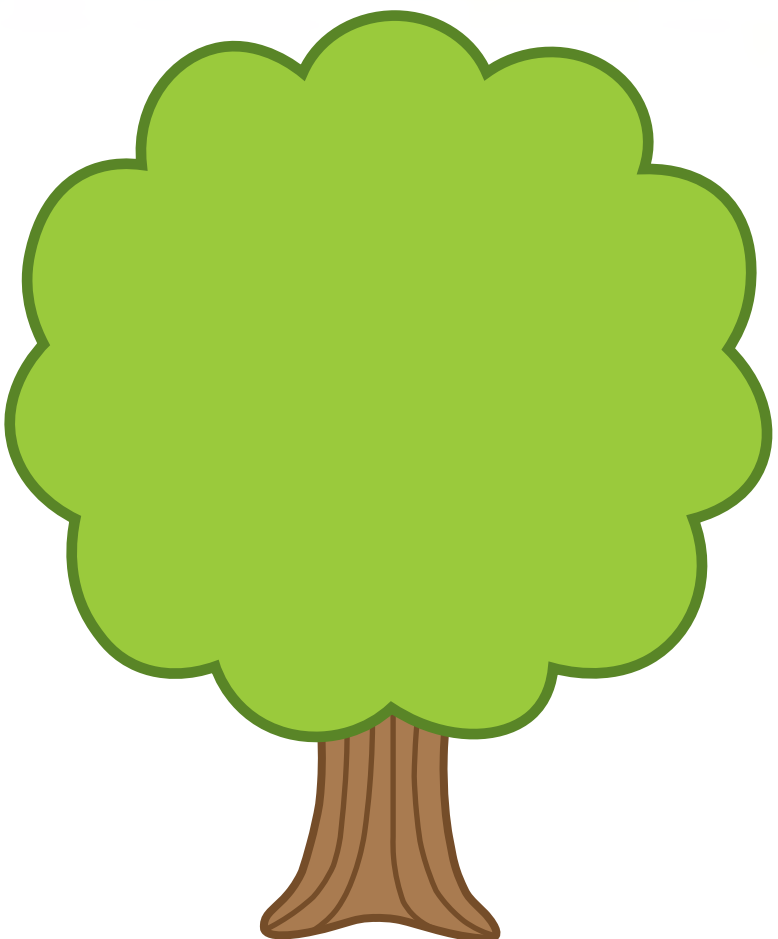

six



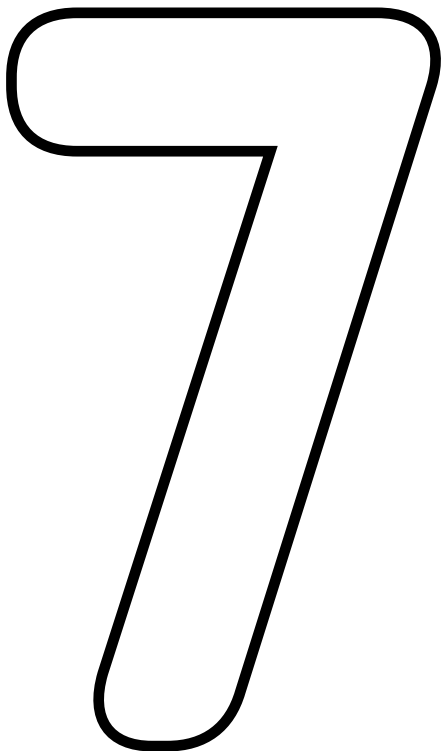

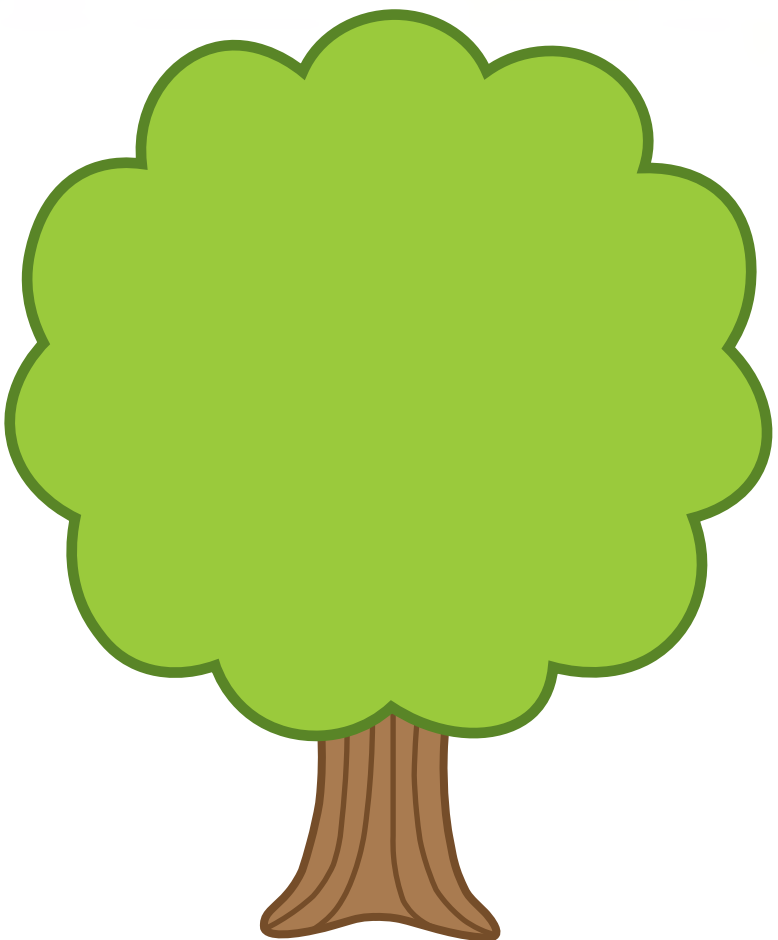

sept



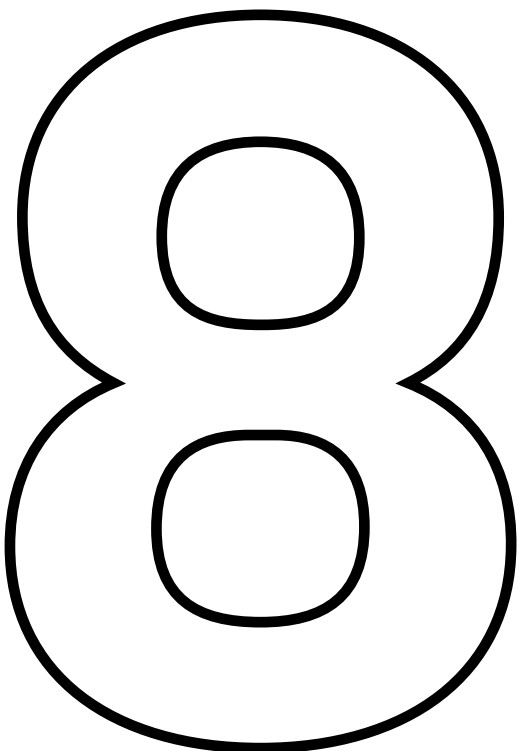

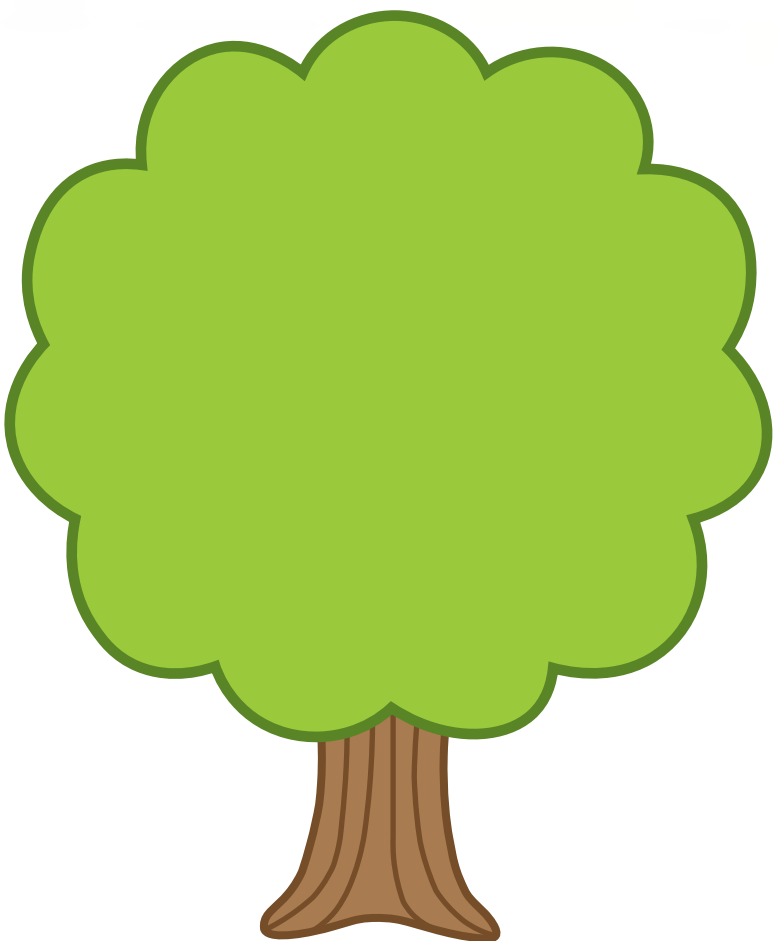

huit



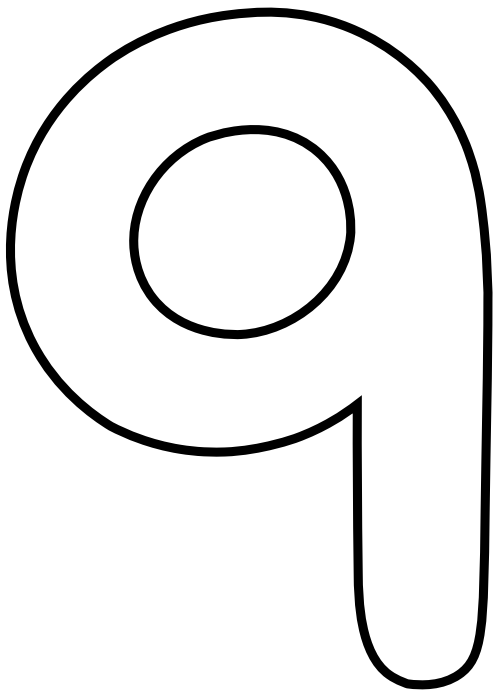

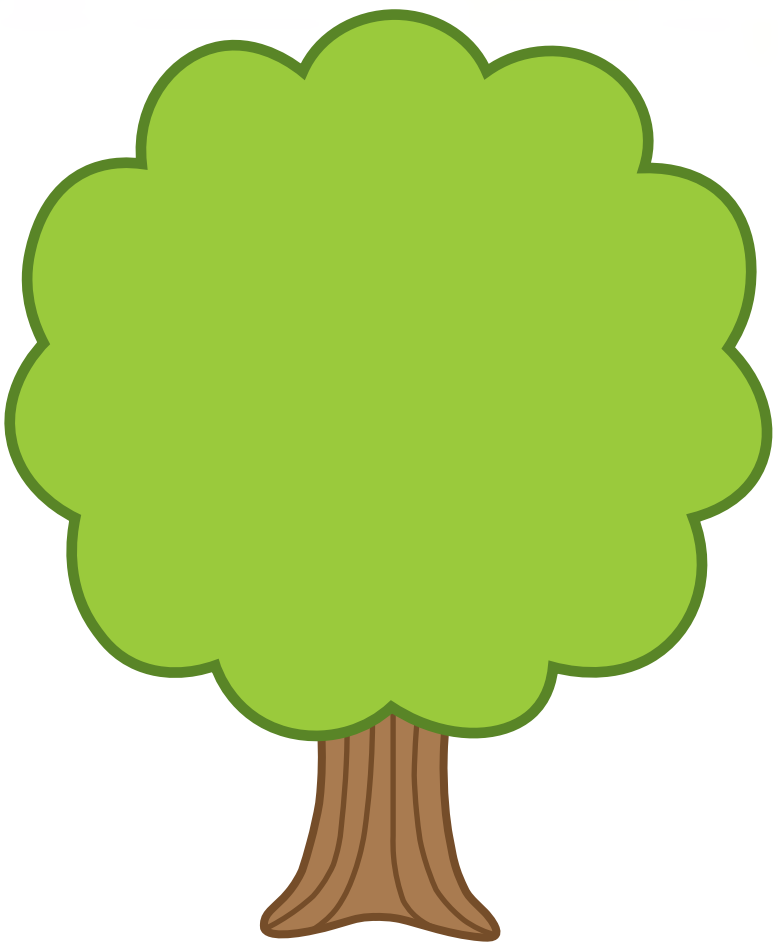

neuf



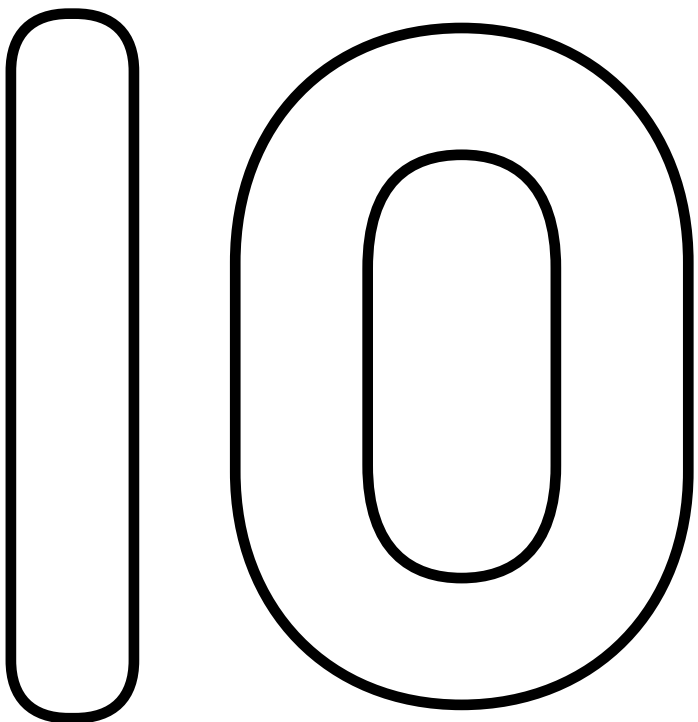

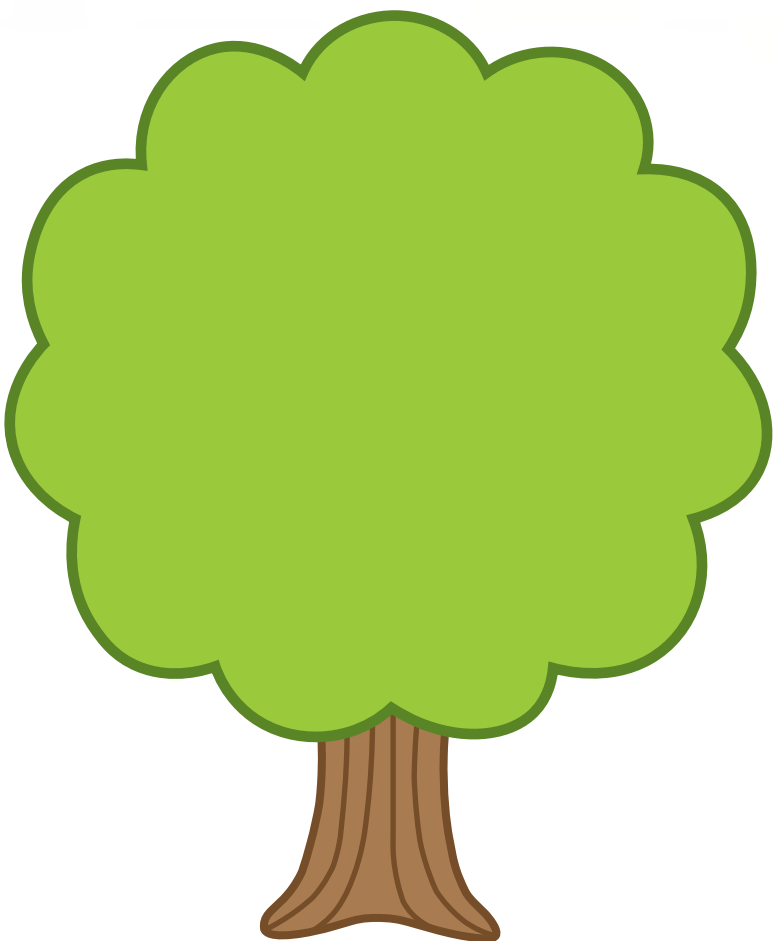

dix



Cartes de représentations imagée et symbolique des nombres - Appariements (1 à 10)

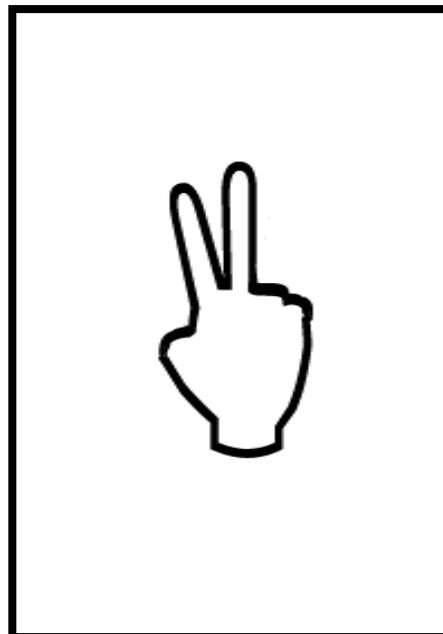
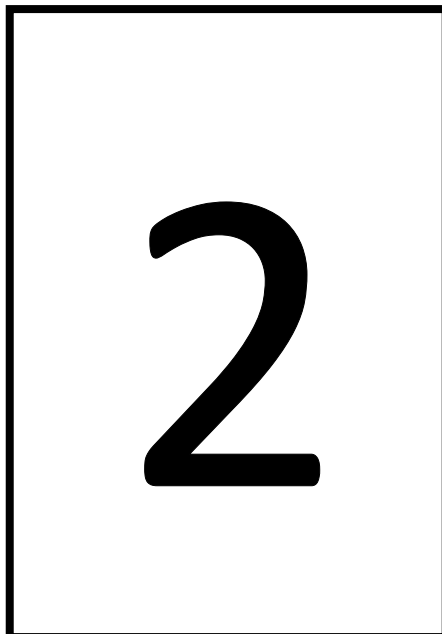
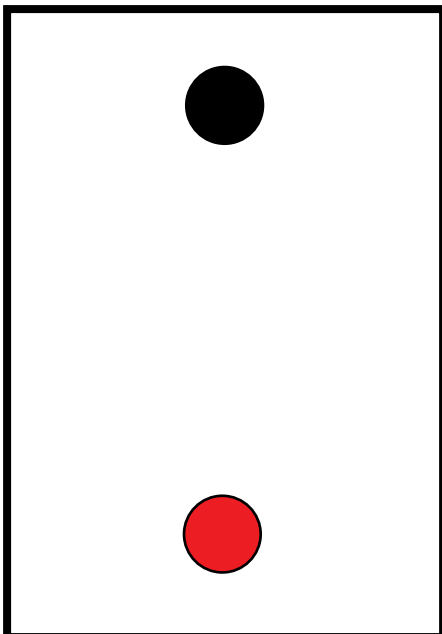
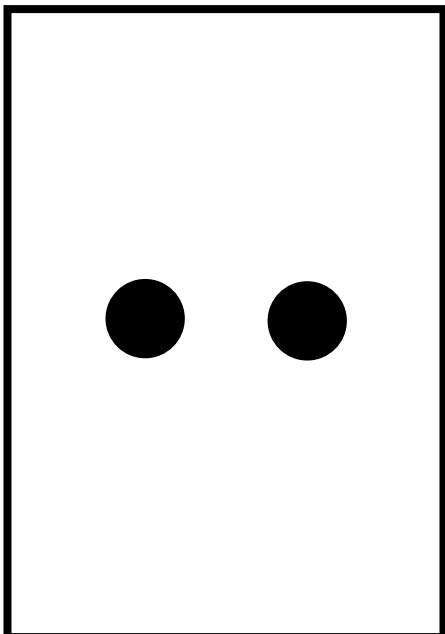
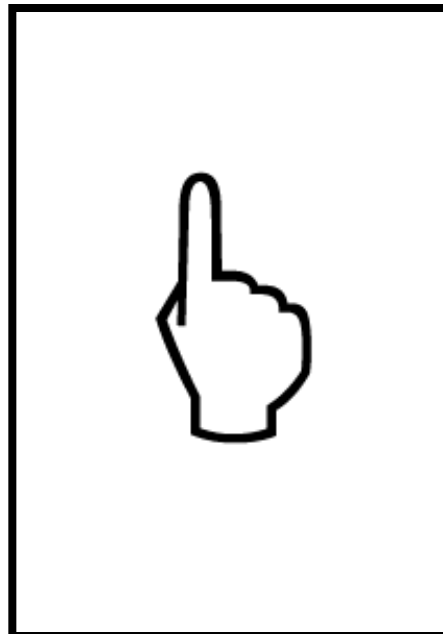
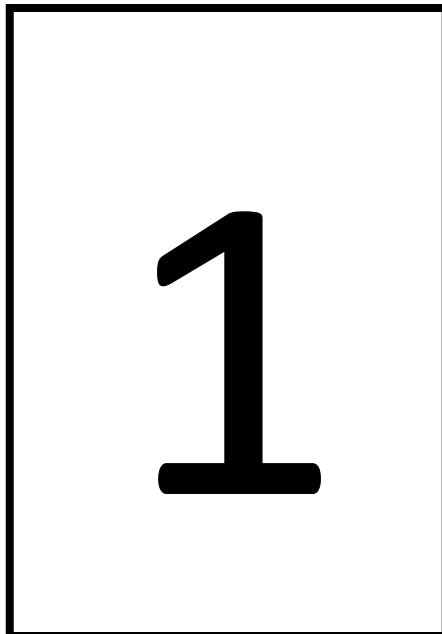
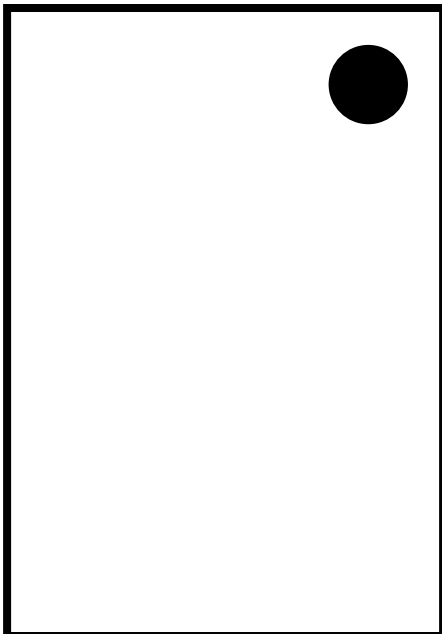
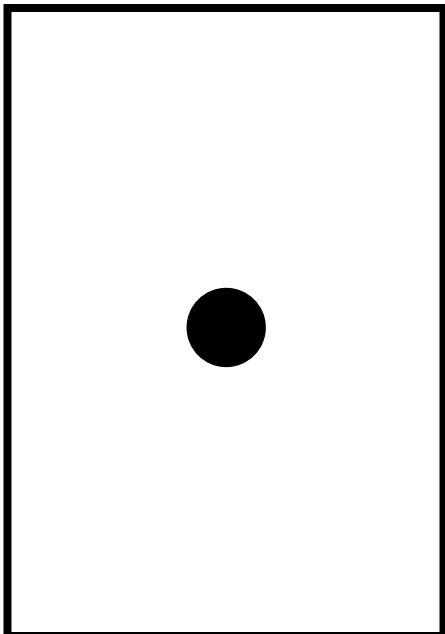

Cartes de représentations imagée et symbolique des nombres - Appariements (1 à 10) (suite)

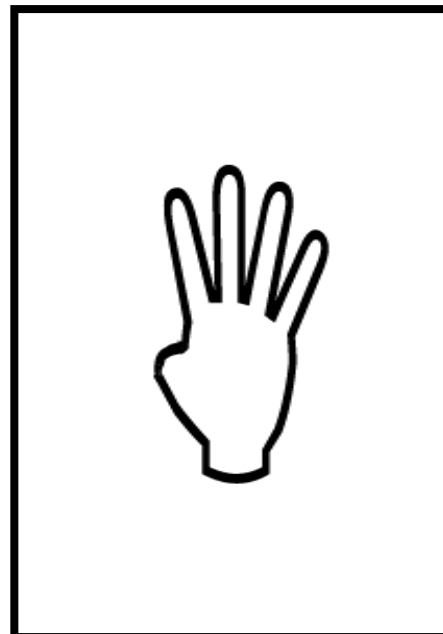
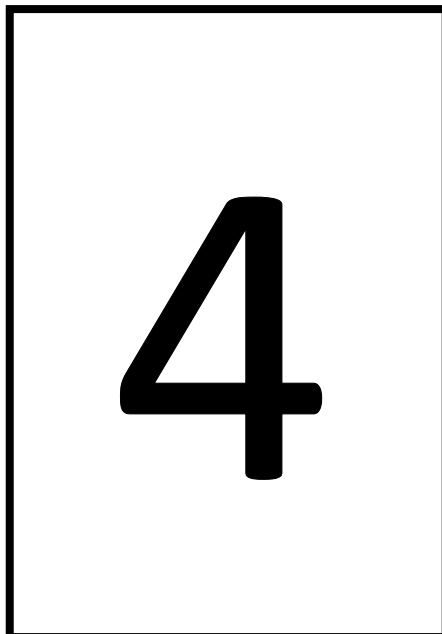
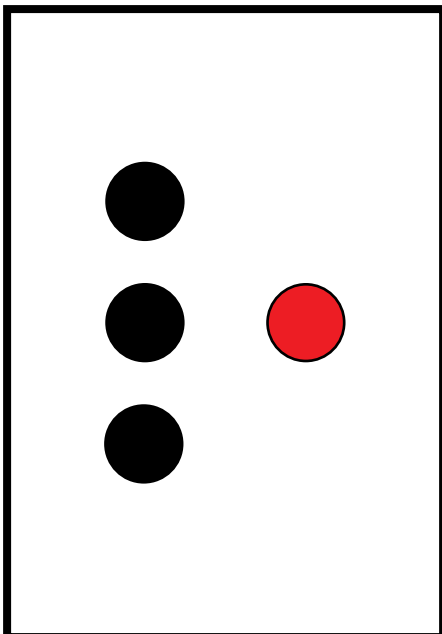
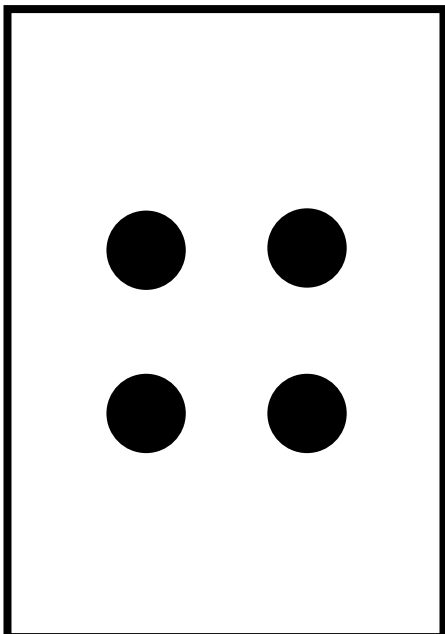
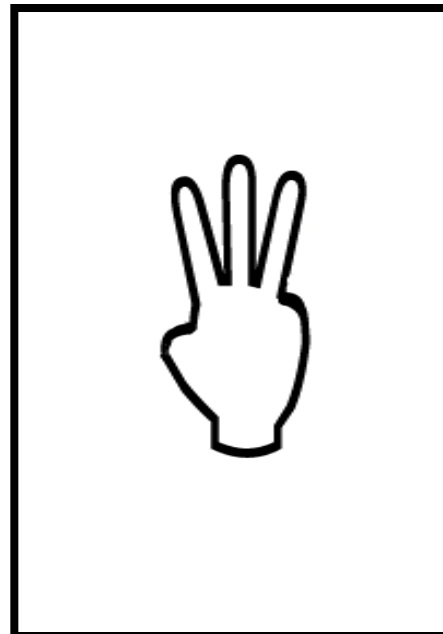
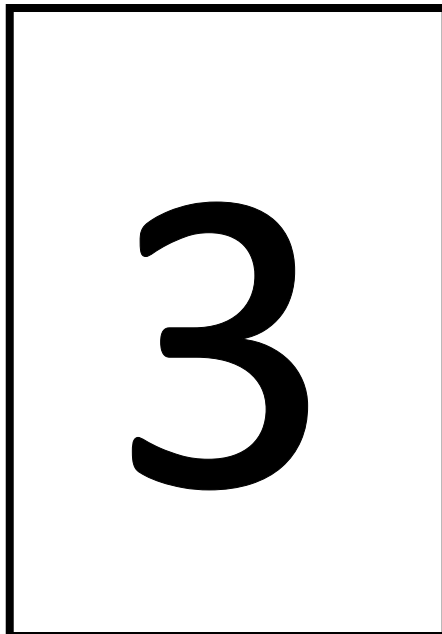
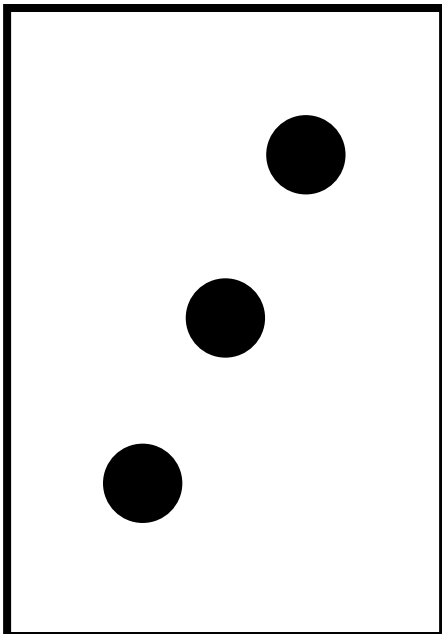
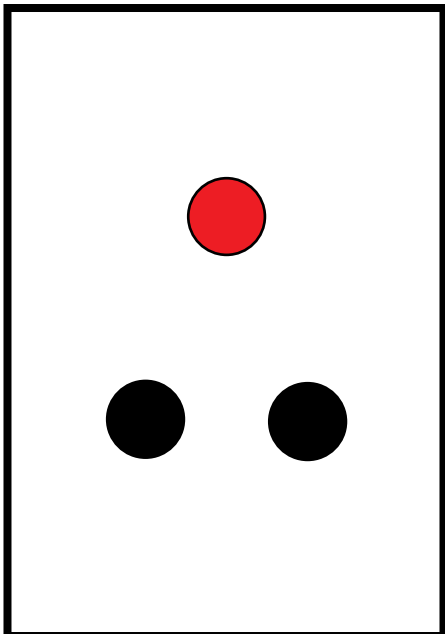

Cartes de représentations imagée et symbolique des nombres - Appariements (1 à 10) (suite)

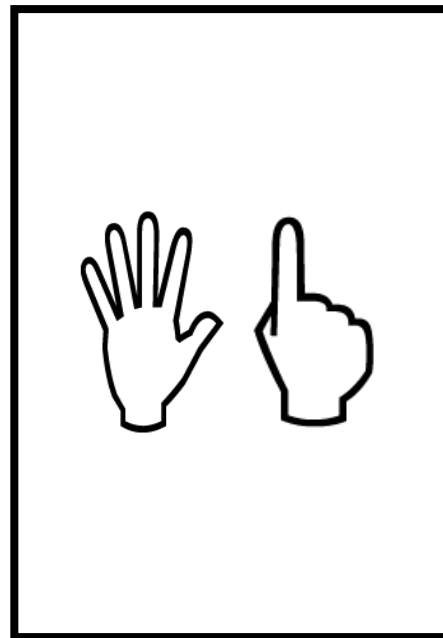
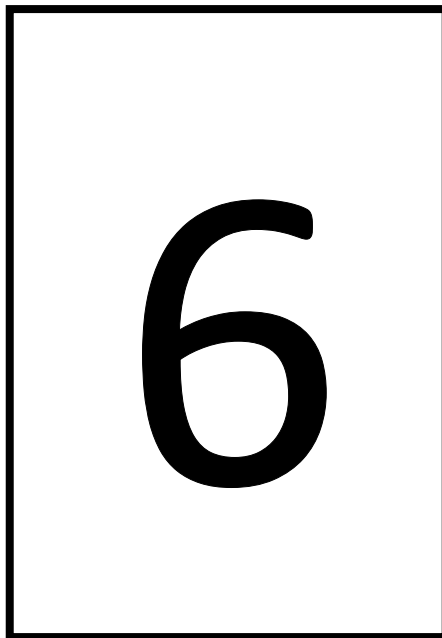
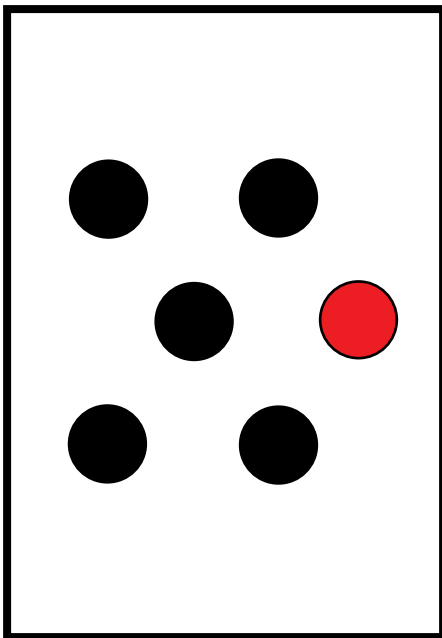
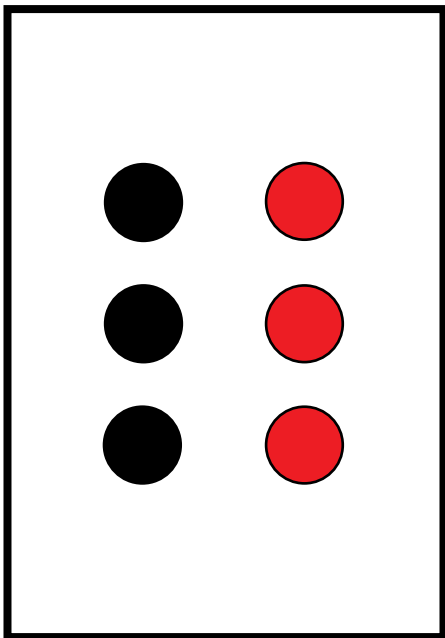
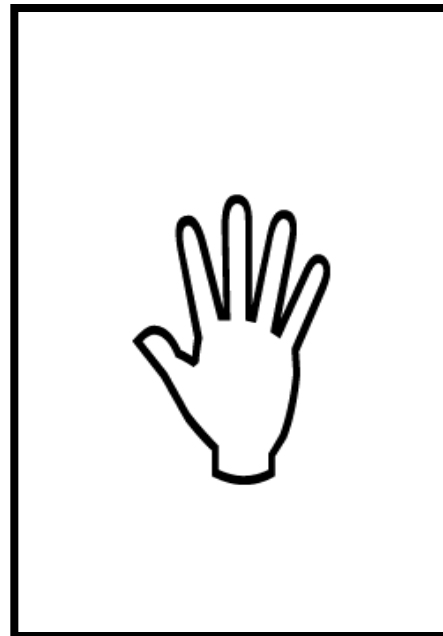
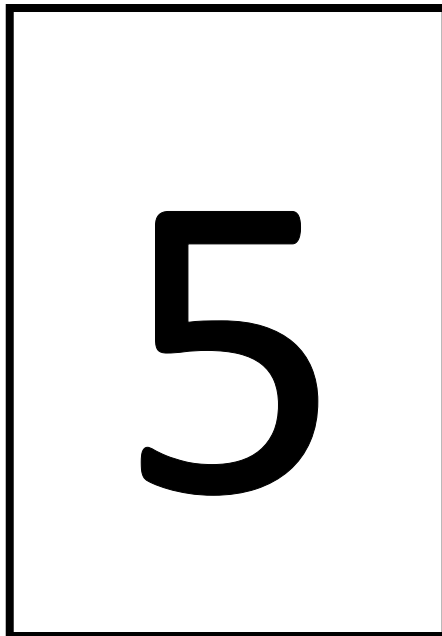
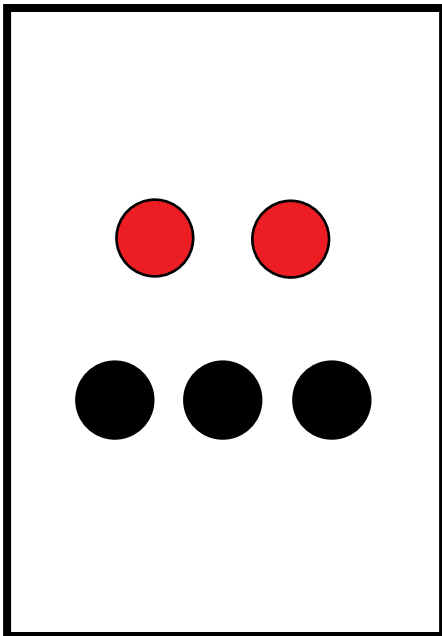
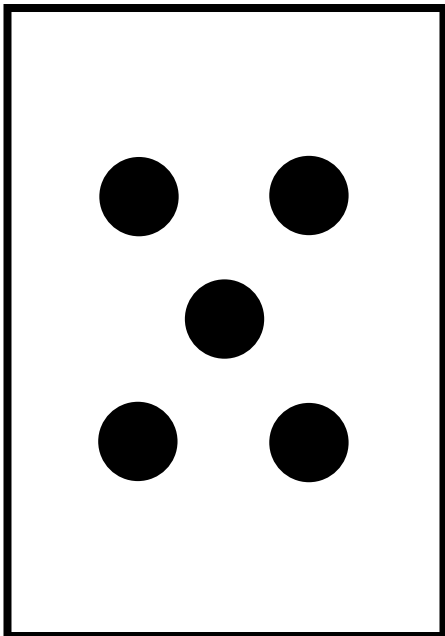

Cartes de représentations imagée et symbolique des nombres - Appariements (1 à 10) (suite)

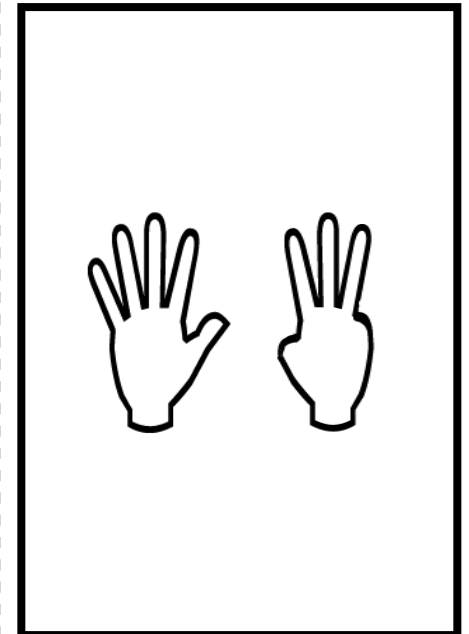
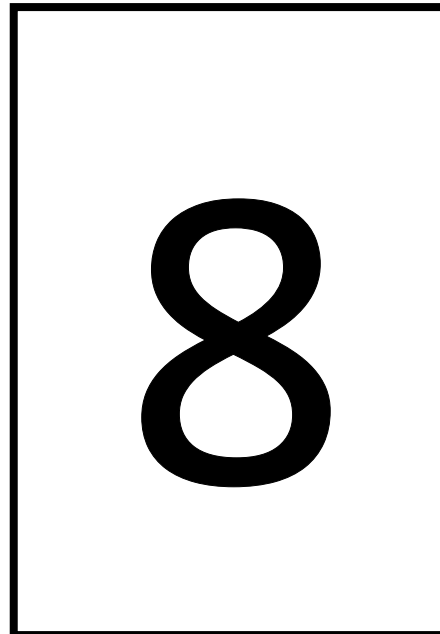
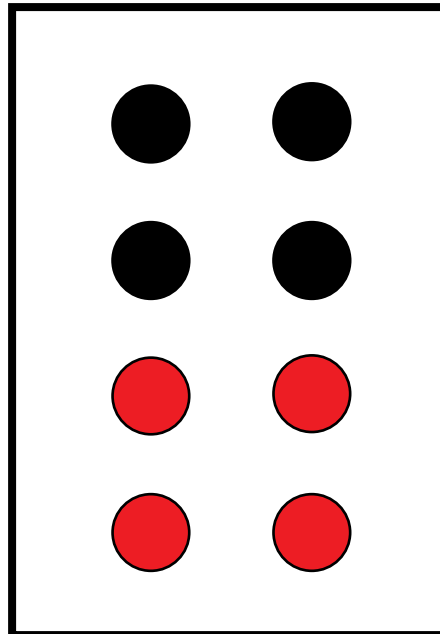
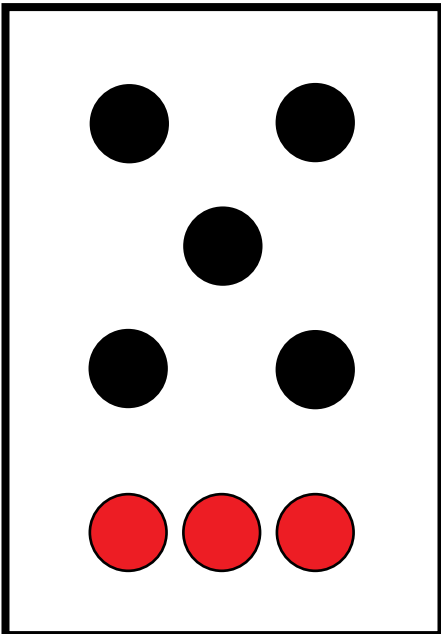
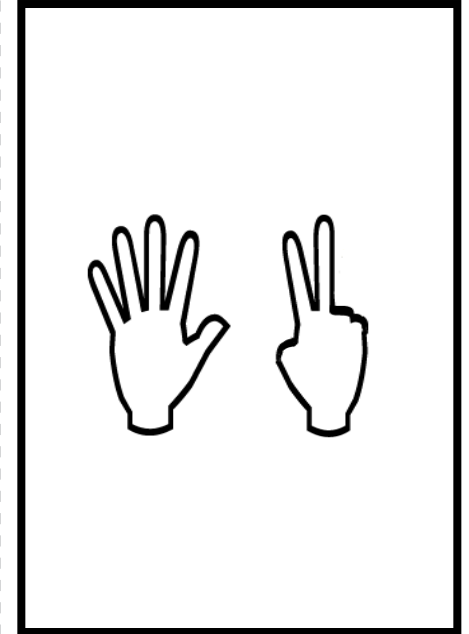
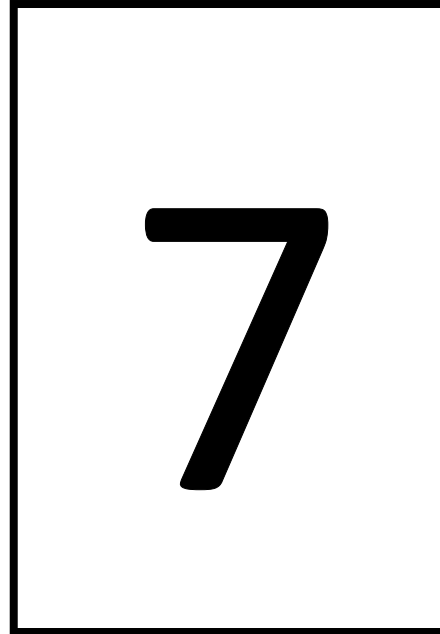
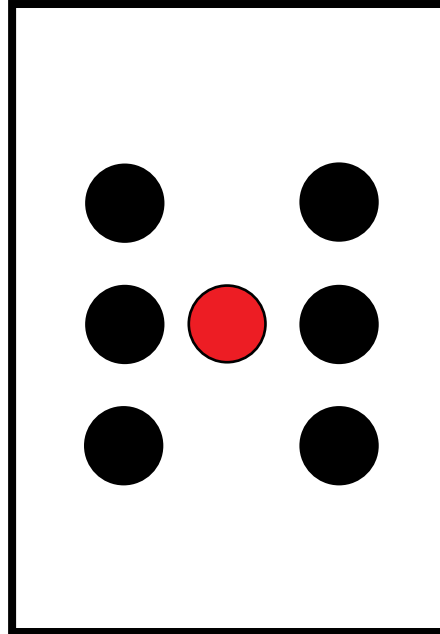
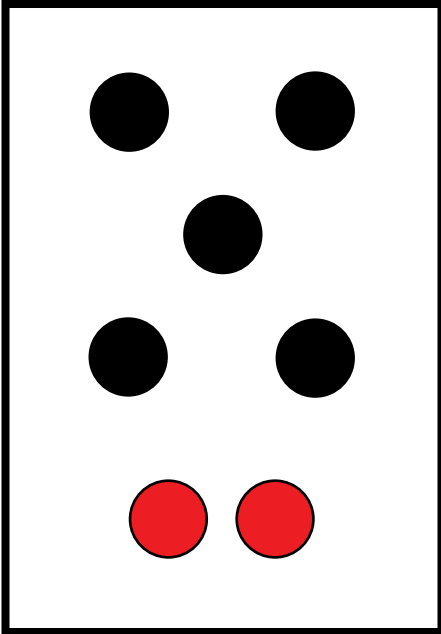

Cartes de représentations imagée et symbolique des nombres - Appariements (1 à 10) (suite)

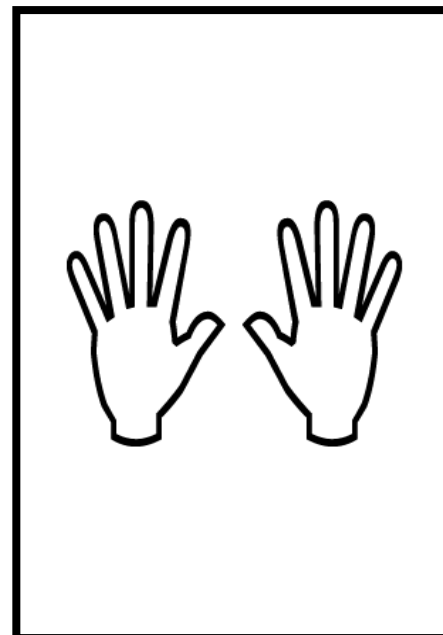
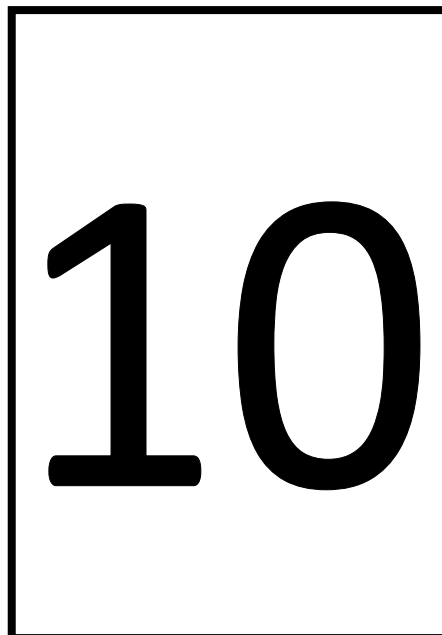
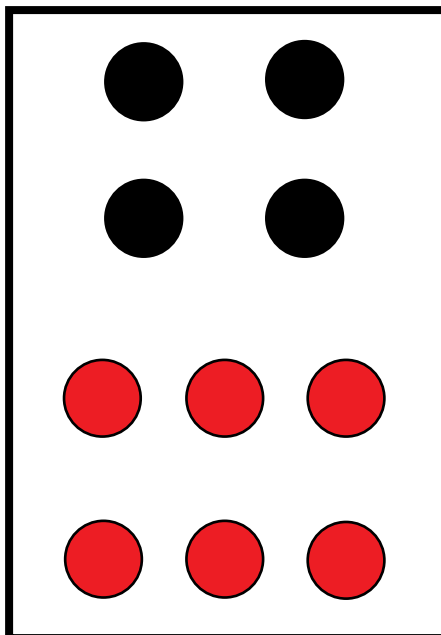
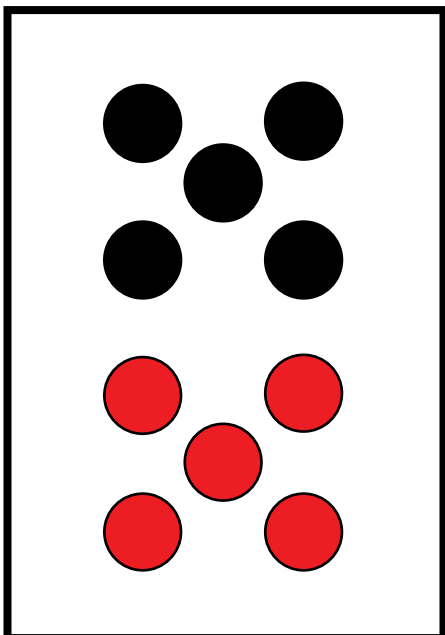
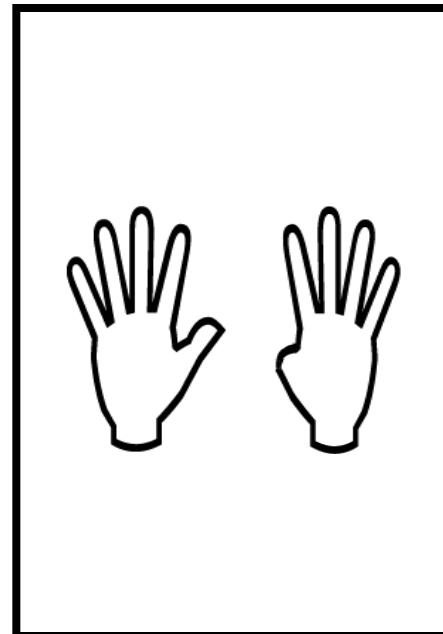
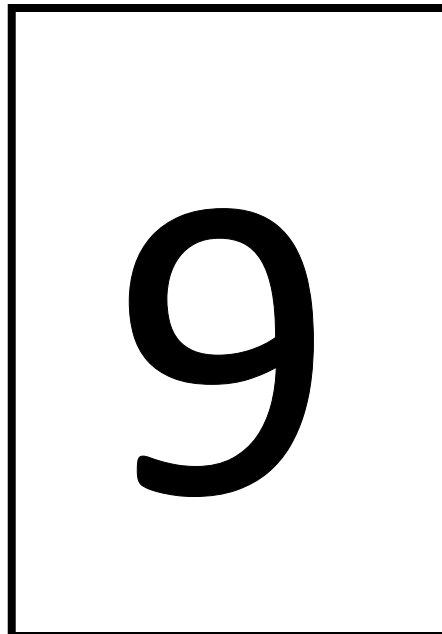
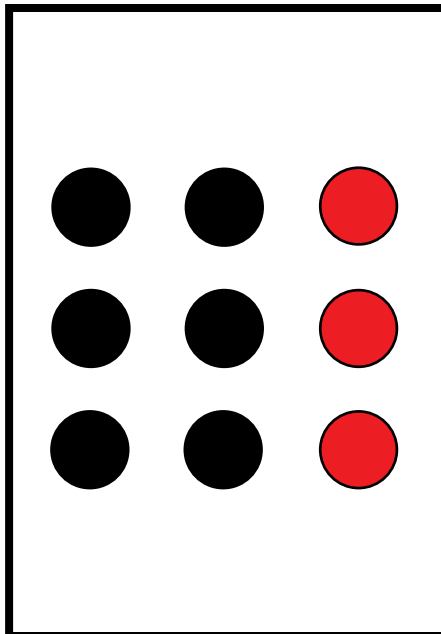
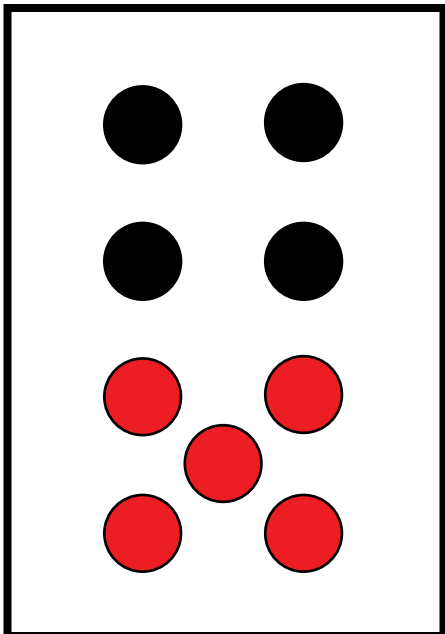

Cartes de représentations imagée et symbolique des nombres

Chiffres et en lettres (1 à 20)

1	2	3	4	5
6	7	8	9	10
11	12	13	14	15
16	17	18	19	20

Cartes de représentations imagée et symbolique des nombres
Chiffres et en lettres (1 à 20) (suite)

un	six
deux	sept
trois	huit
quatre	neuf
cing	dix

Cartes de représentations imagée et symbolique des nombres
Chiffres et en lettres (1 à 20) (suite)

onze	seize
douze	dix-sept
treize	dix-huit
quatorze	dix-neuf
quinze	vingt





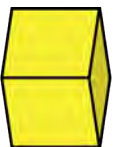
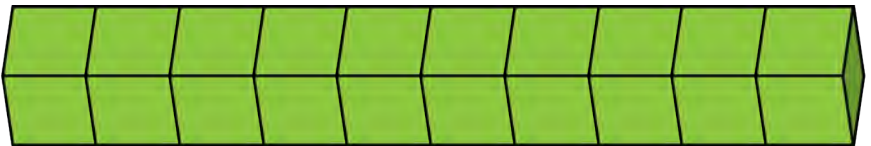





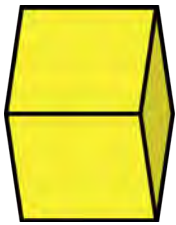









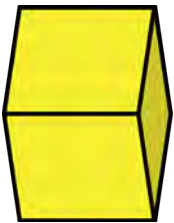



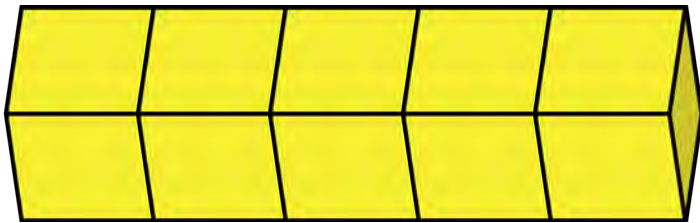

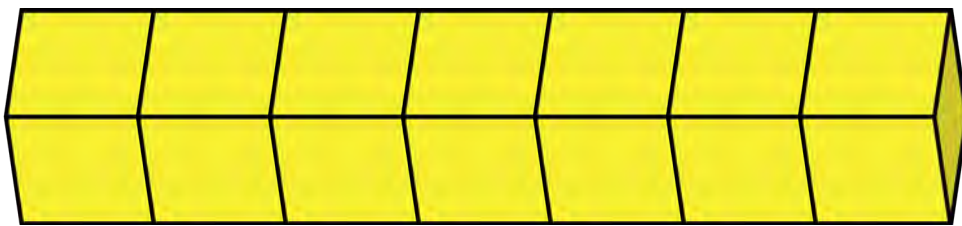



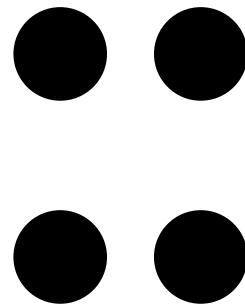
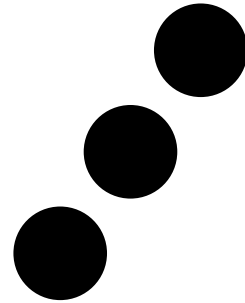

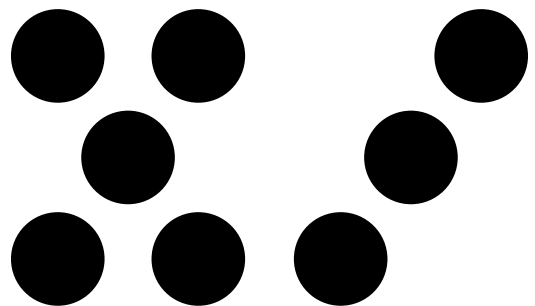
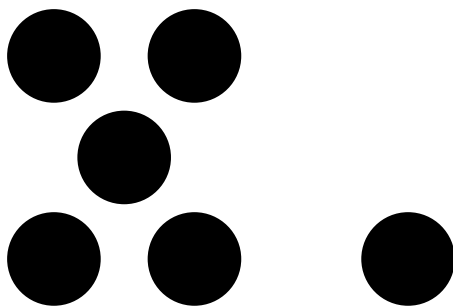
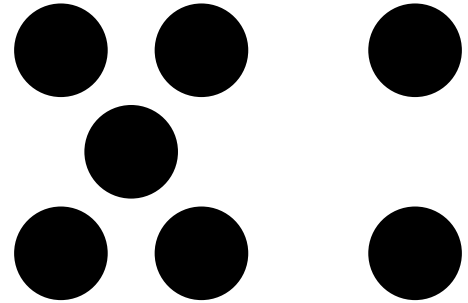
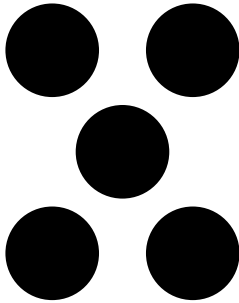

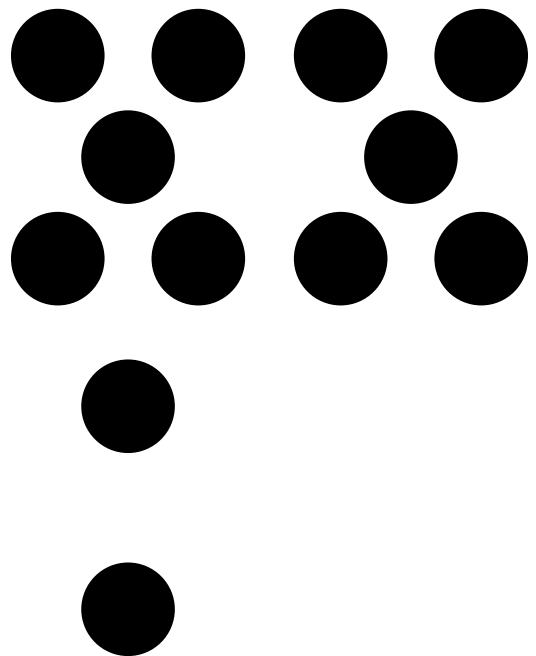
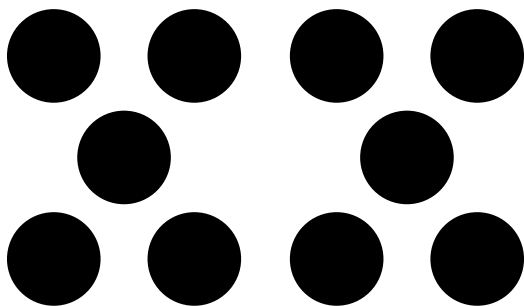
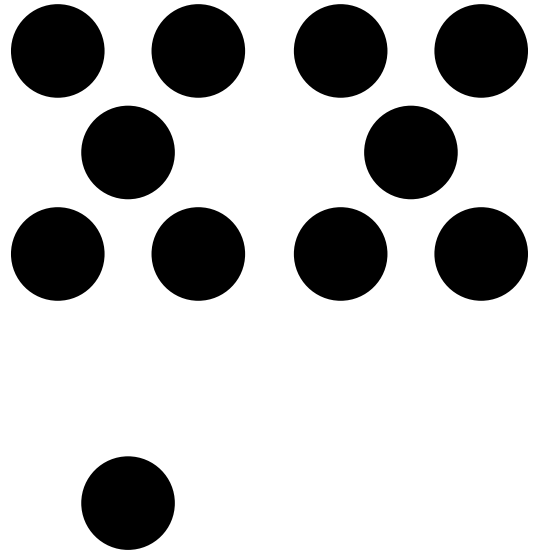
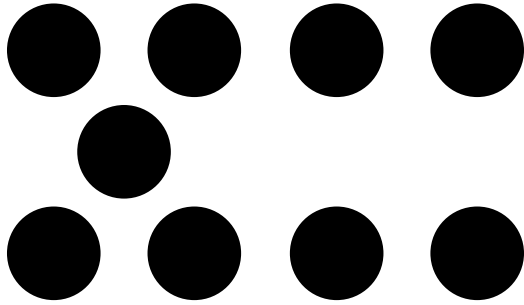

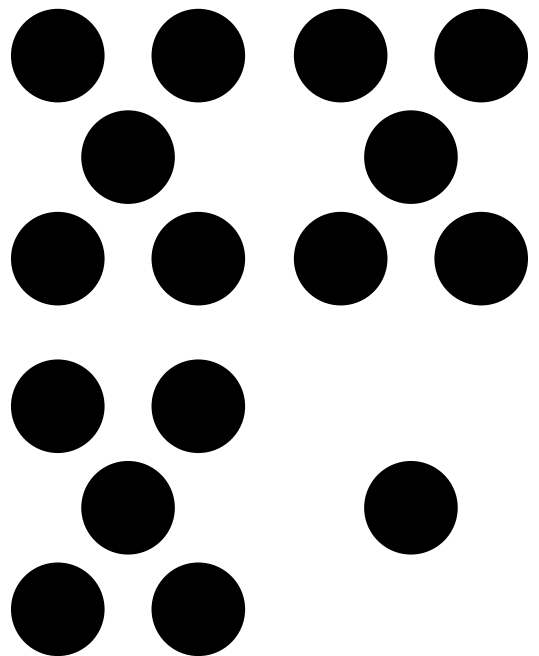
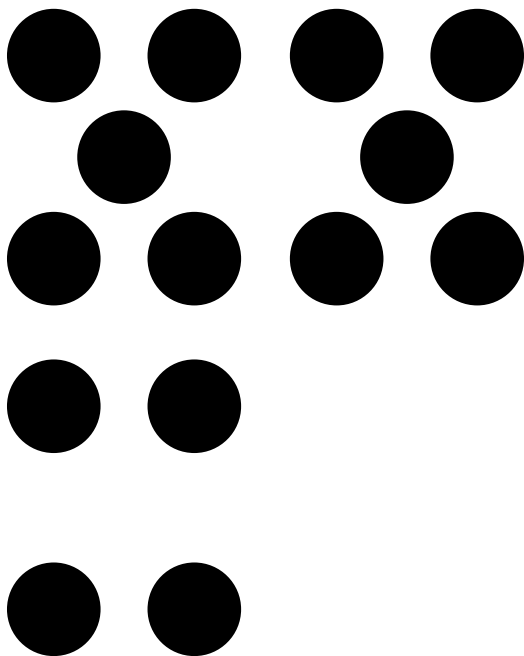
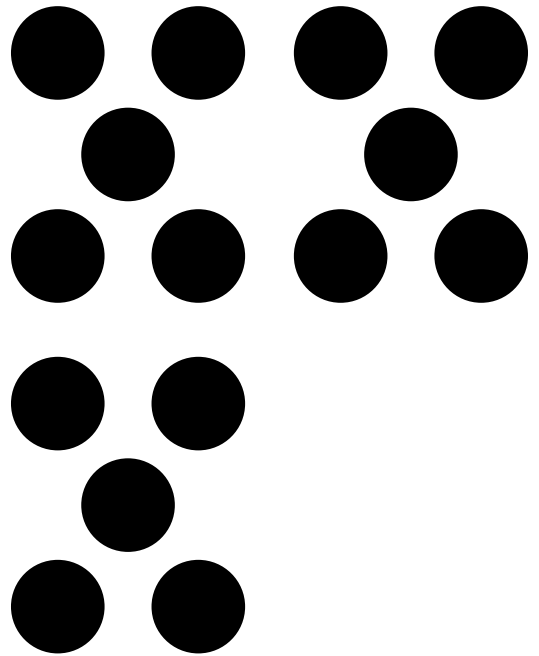
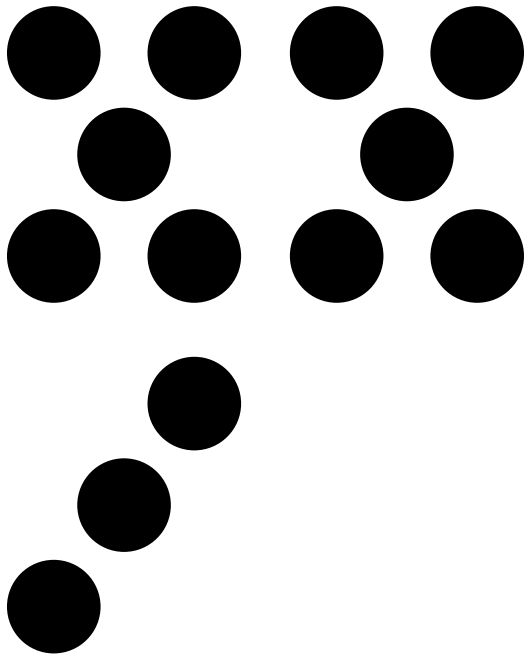

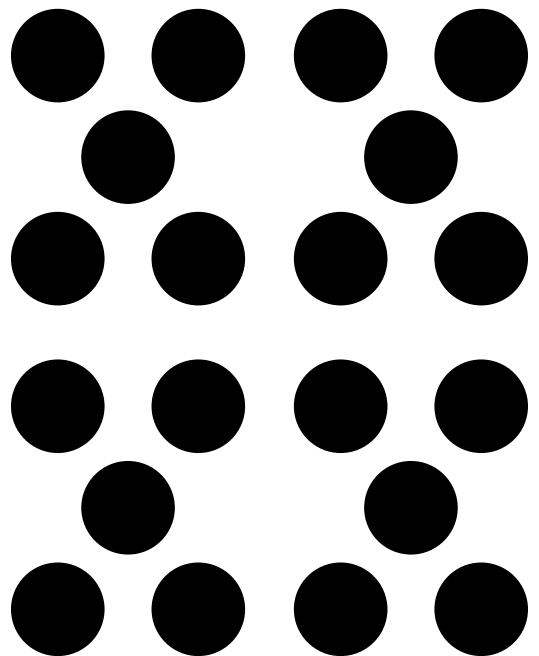
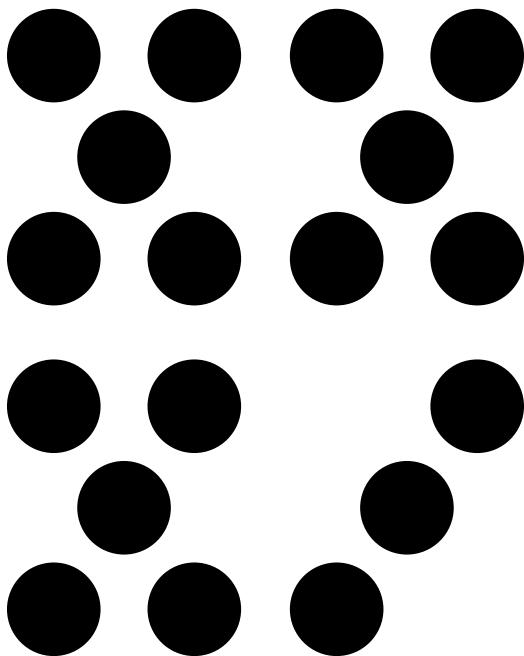
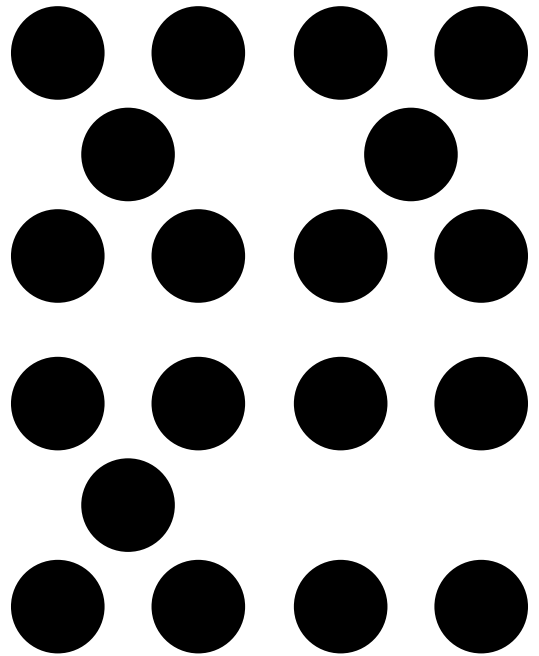
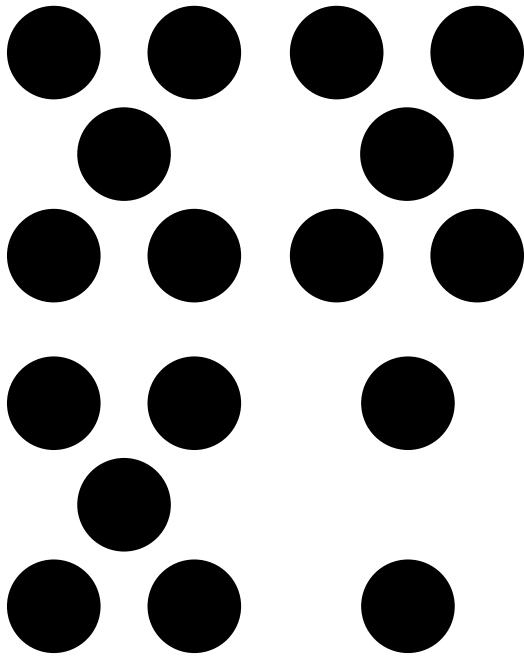

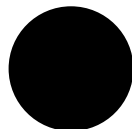
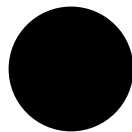
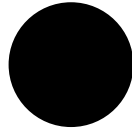

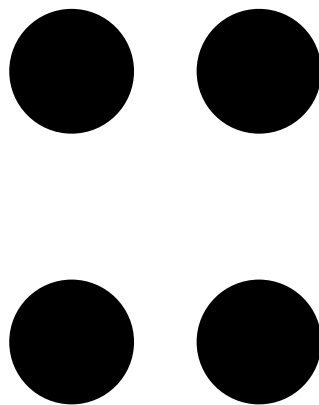
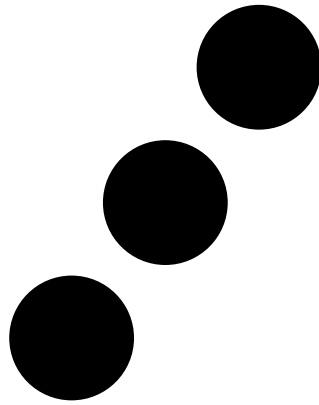

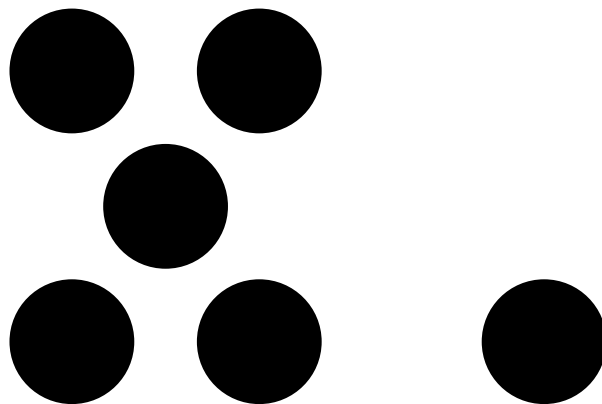
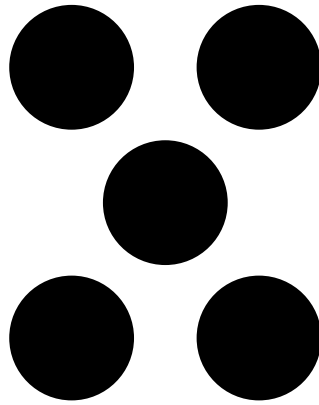

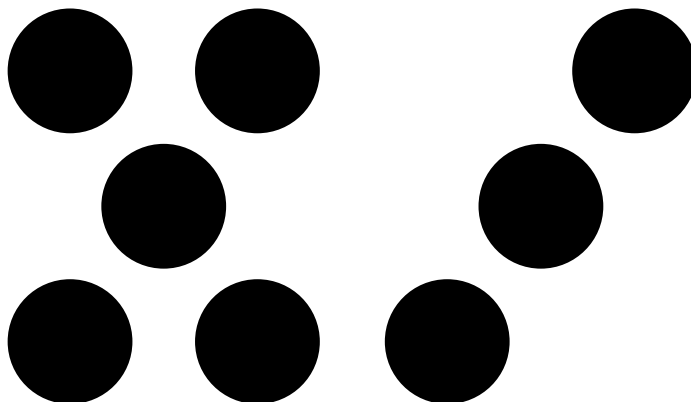
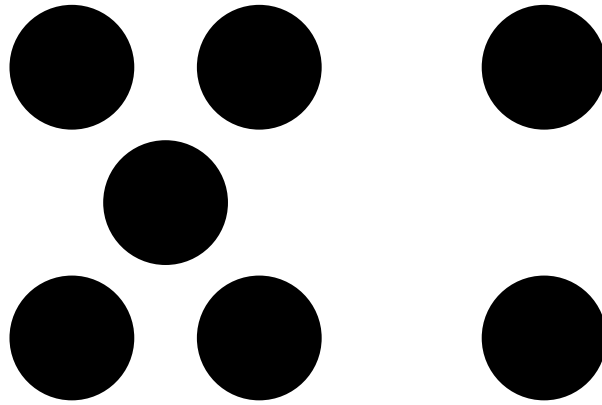

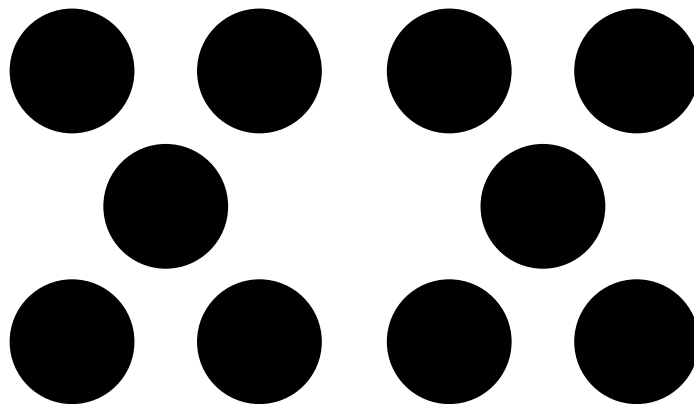
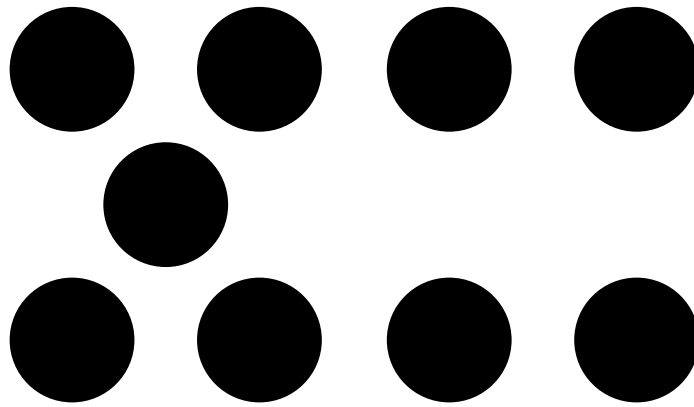

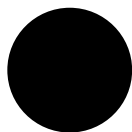
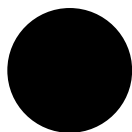
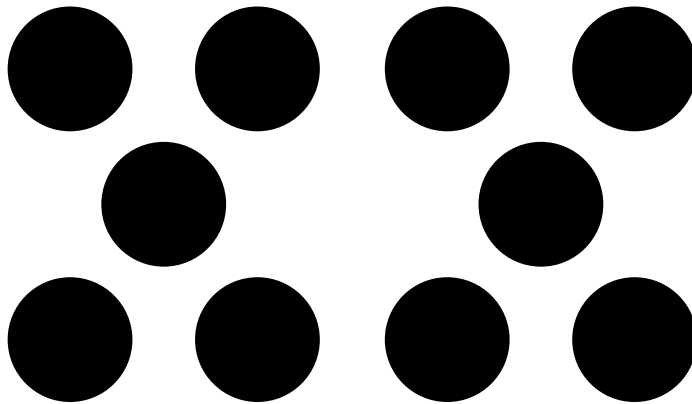
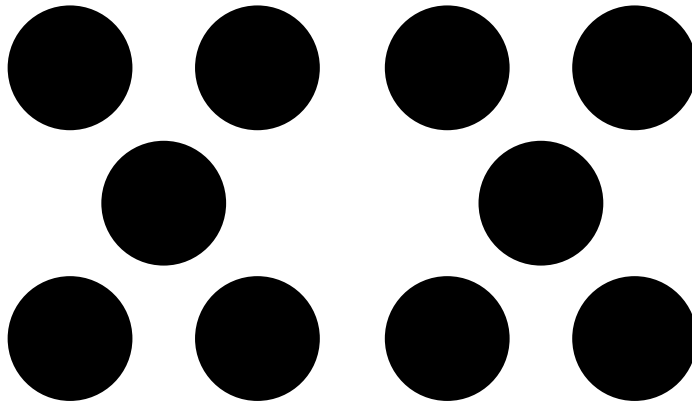

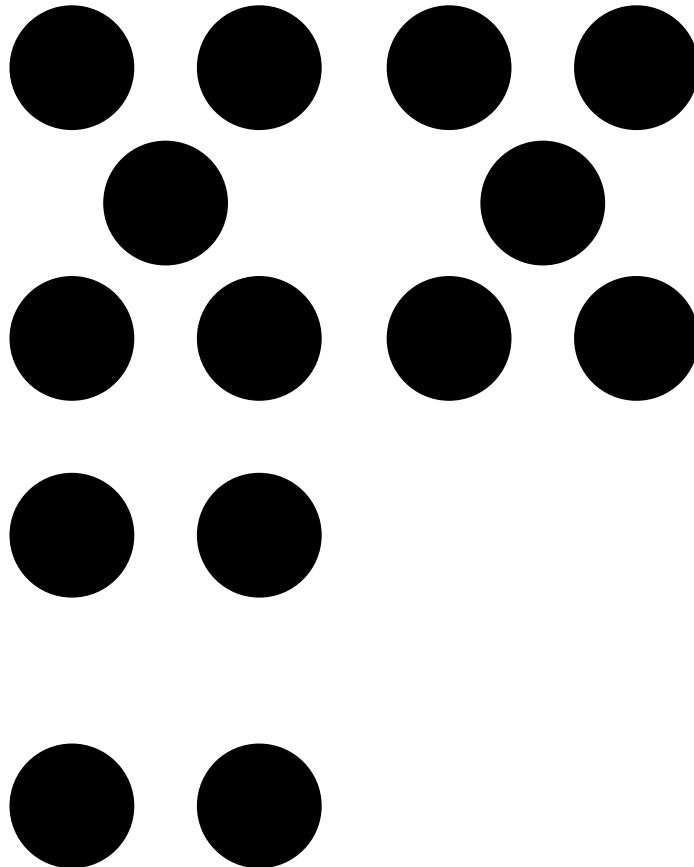
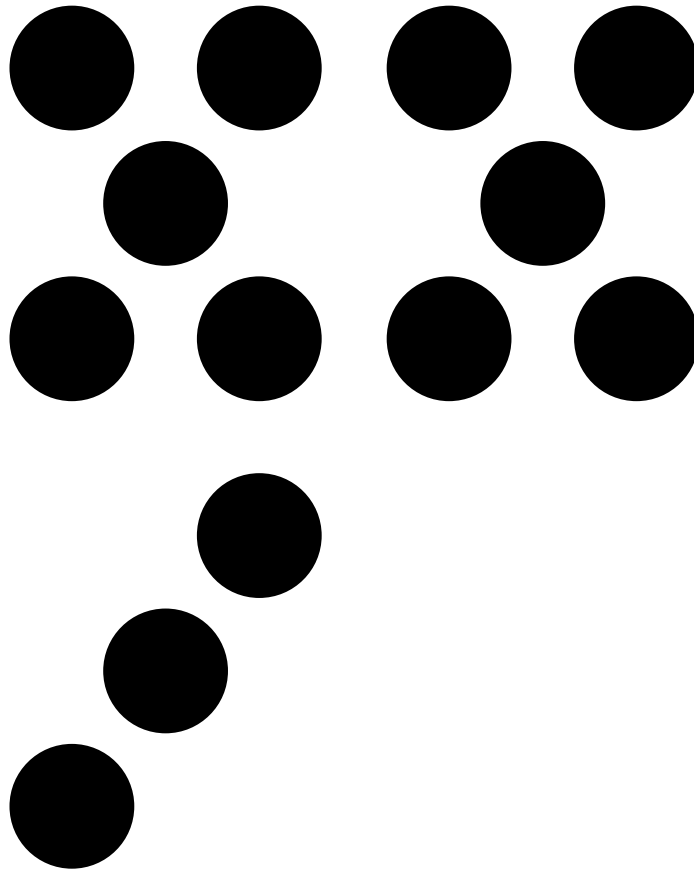

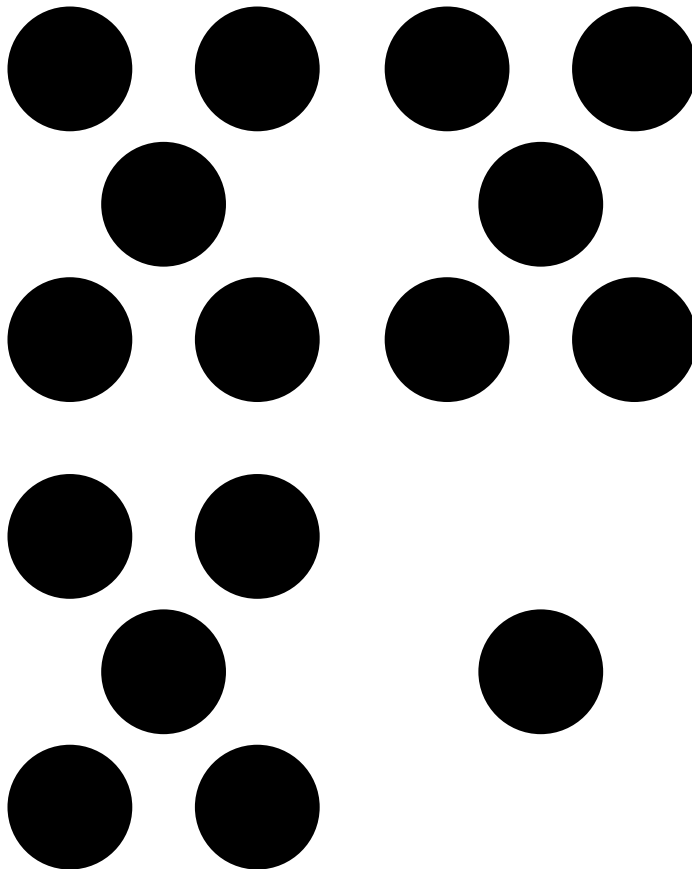
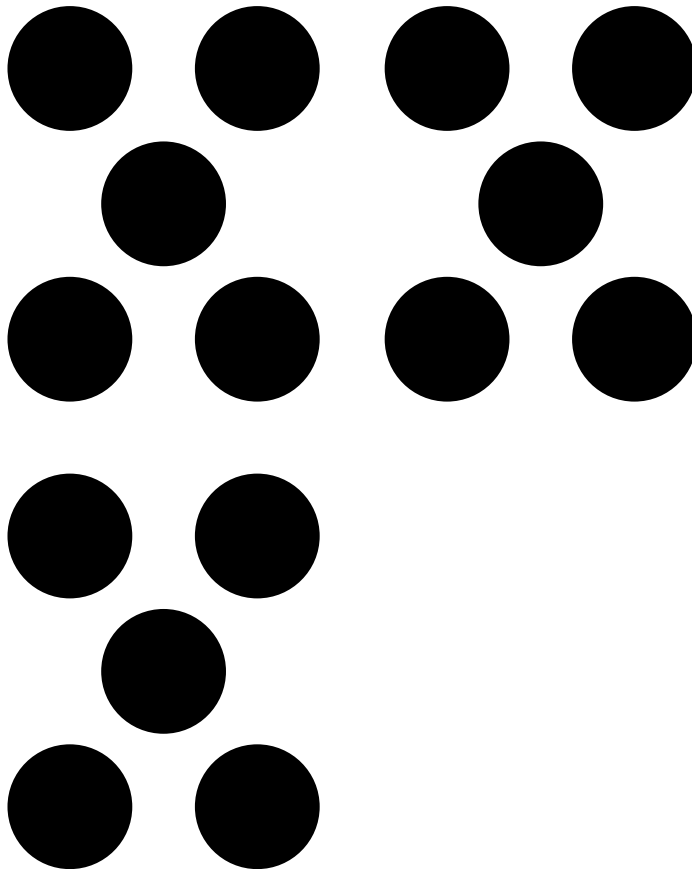

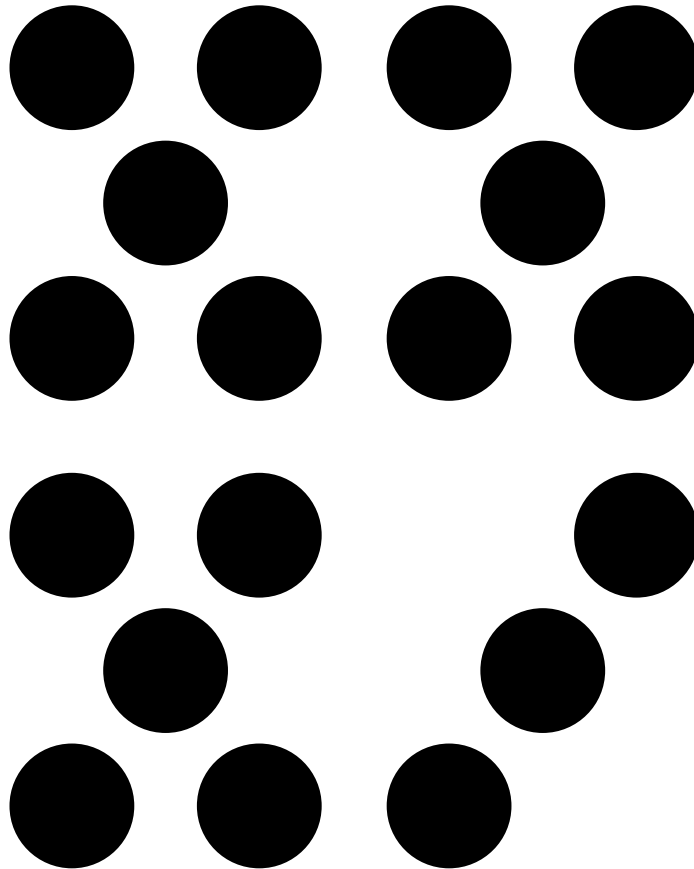
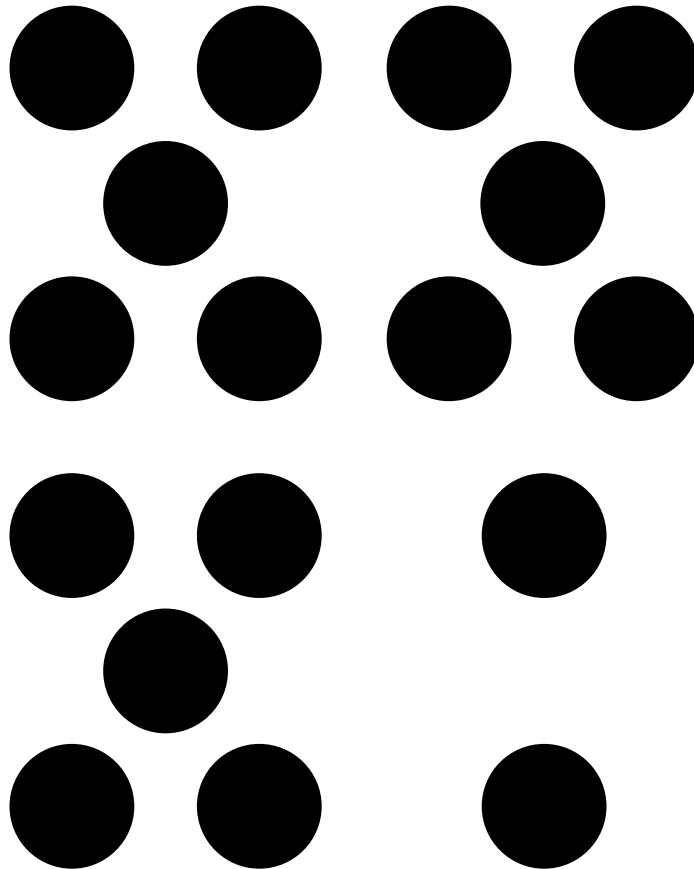

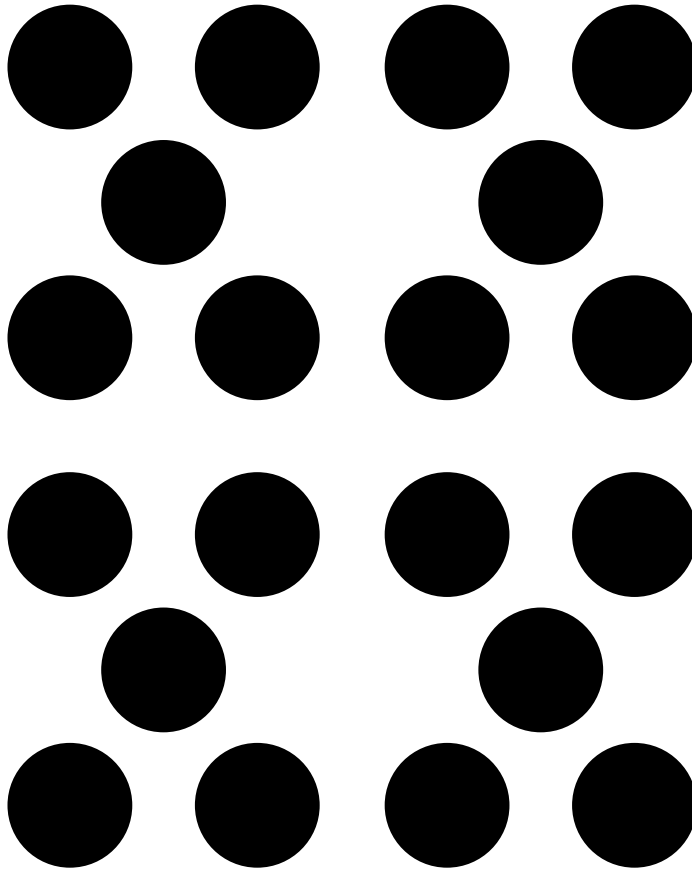
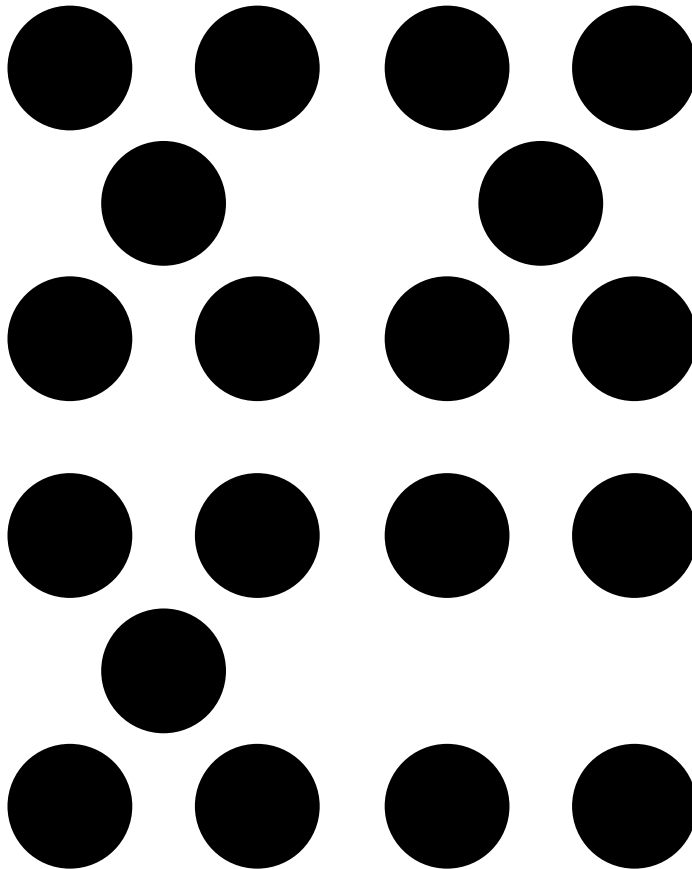

3

4

1

2



7

8

5

6



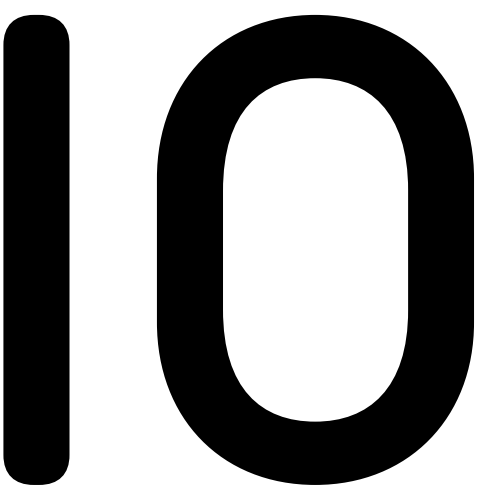
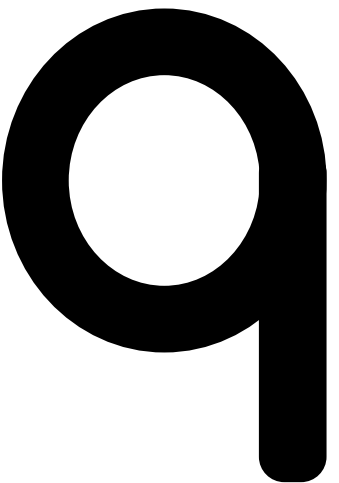
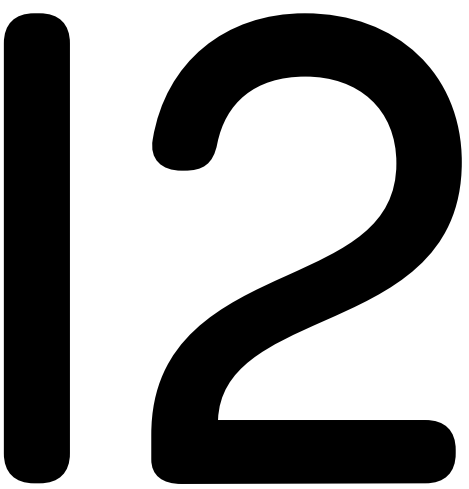
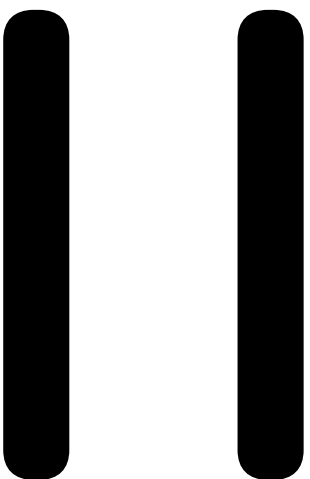

15

1

16

1

13

1

14

1



19

20

17

18



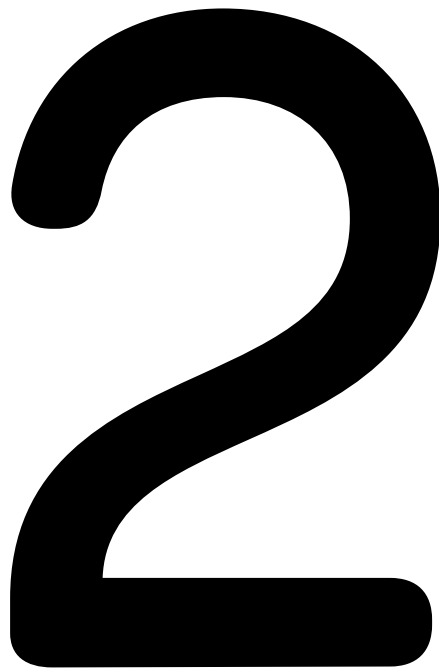



3



4





5



6





7



8



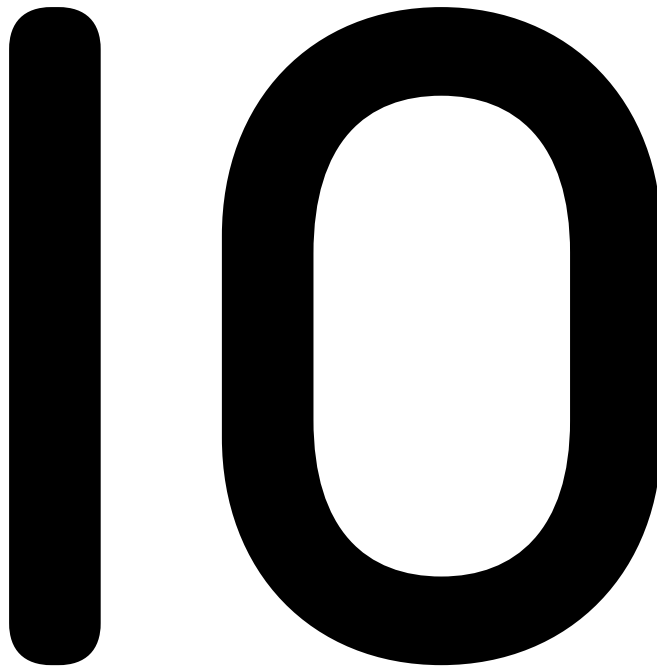
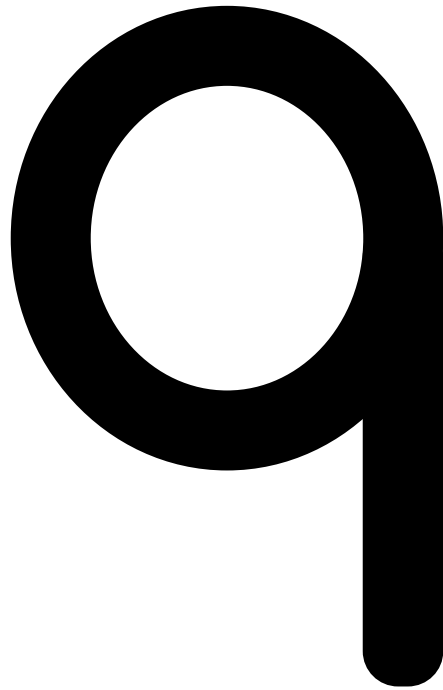

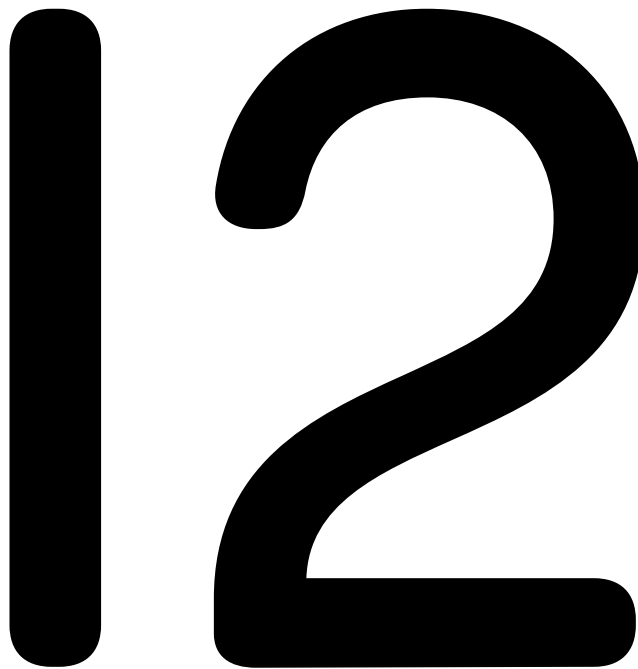
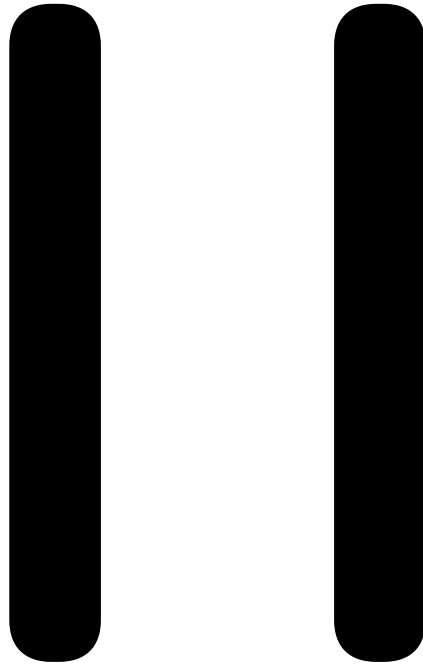



13



14





15



16





17



18





19



20



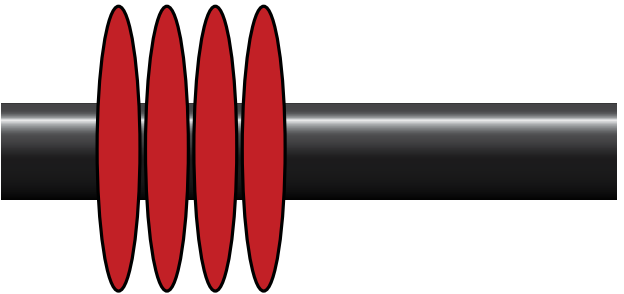
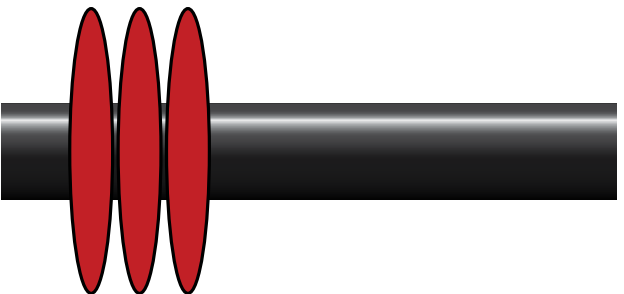

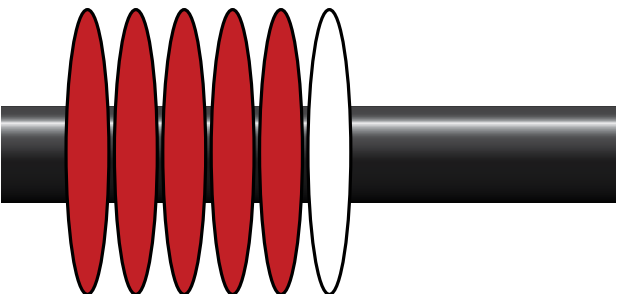
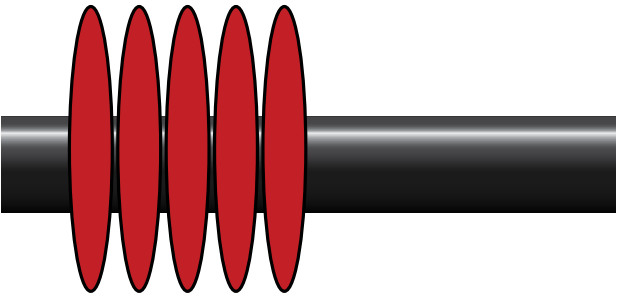
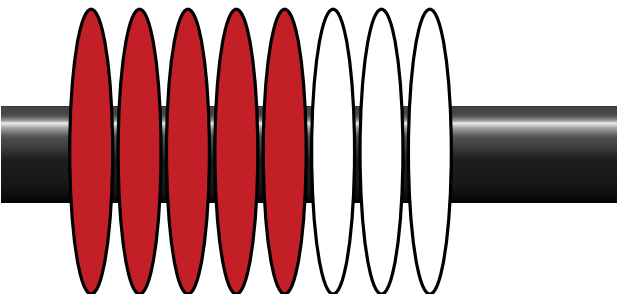
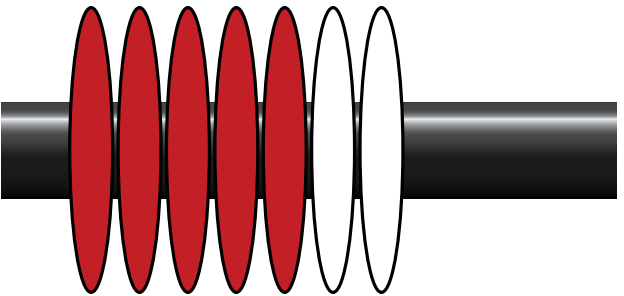

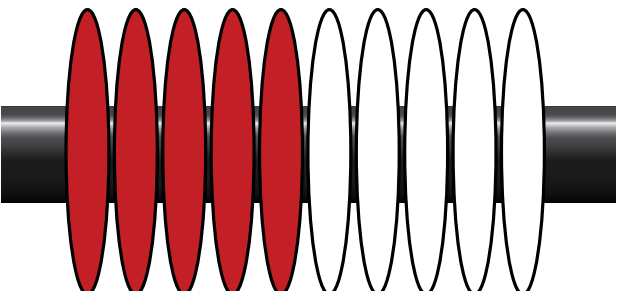
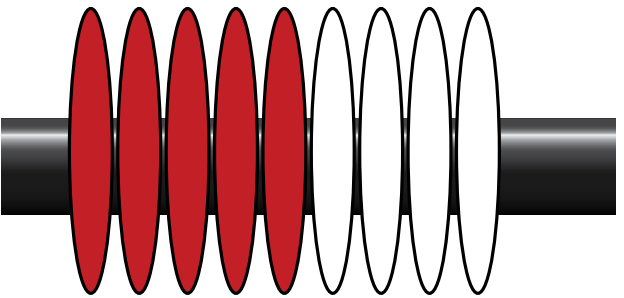
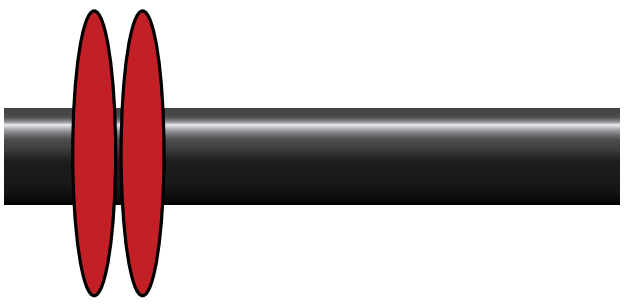
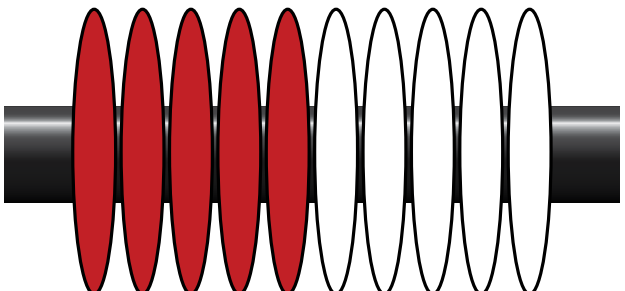
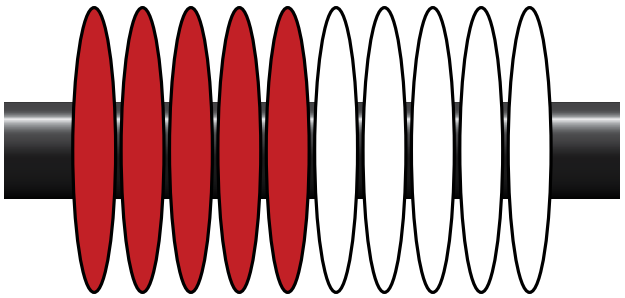

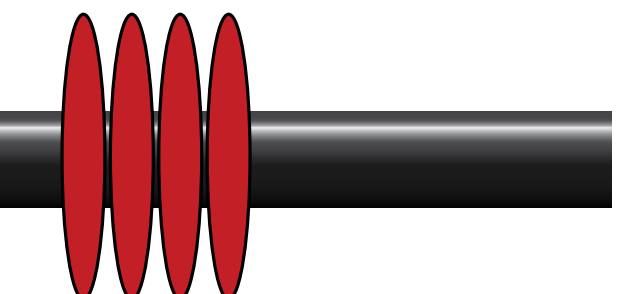
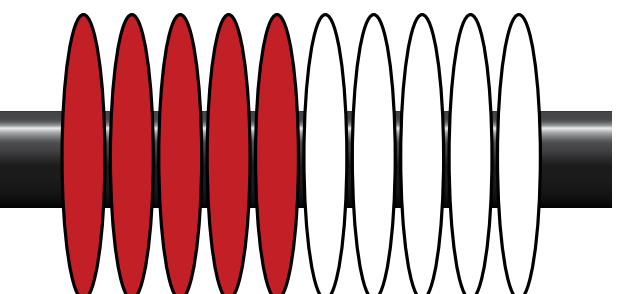
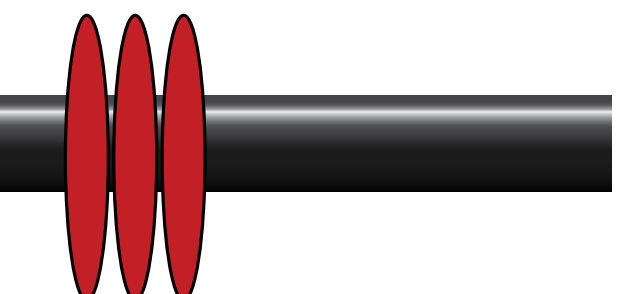
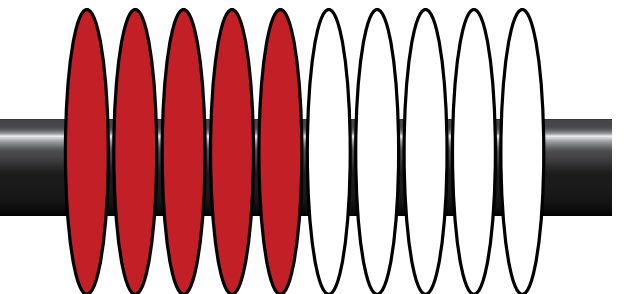
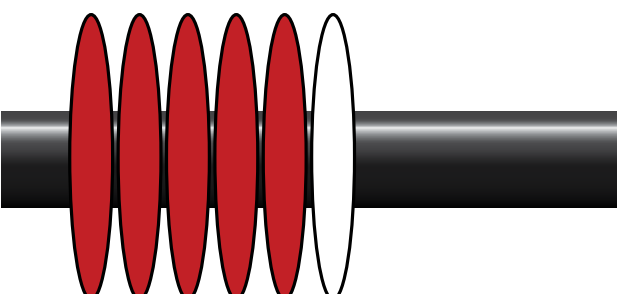
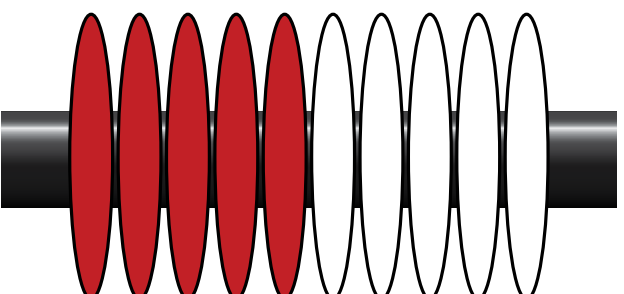
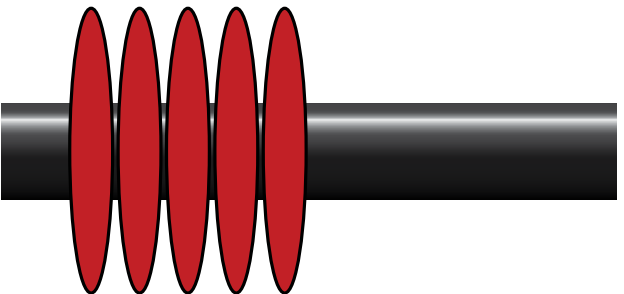
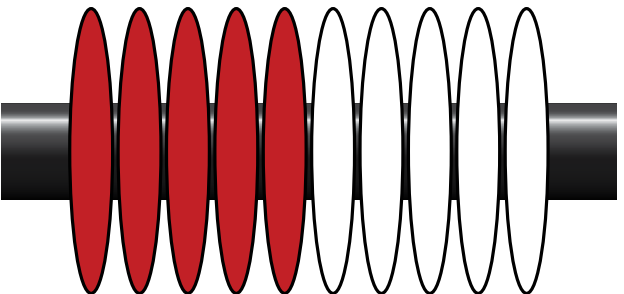

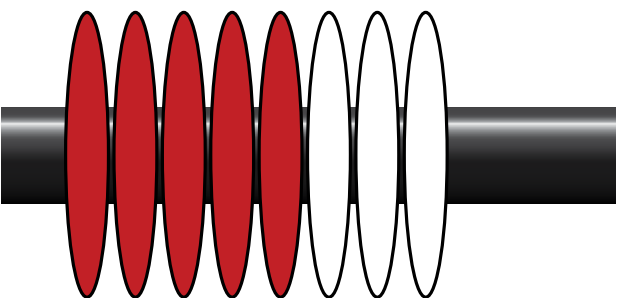
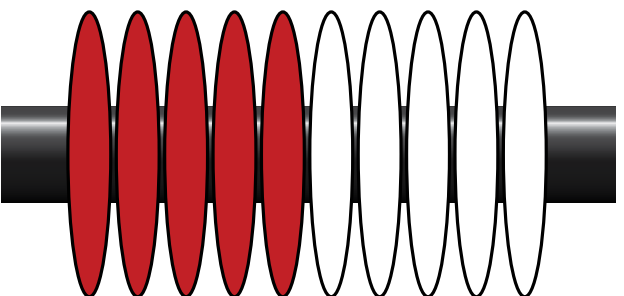
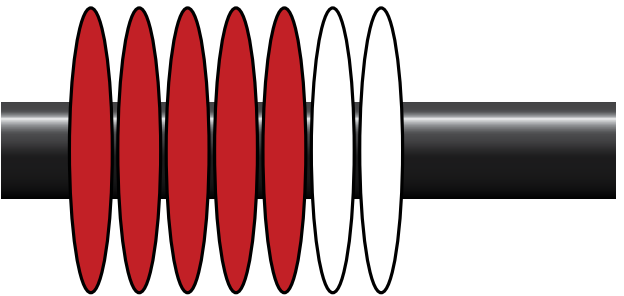
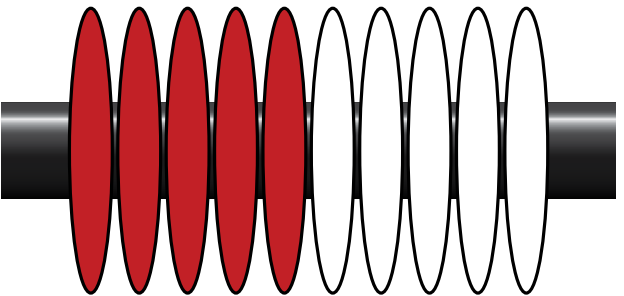
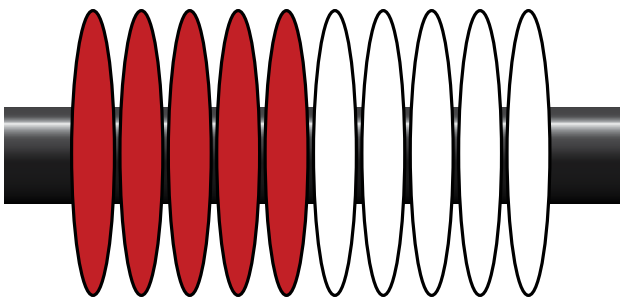
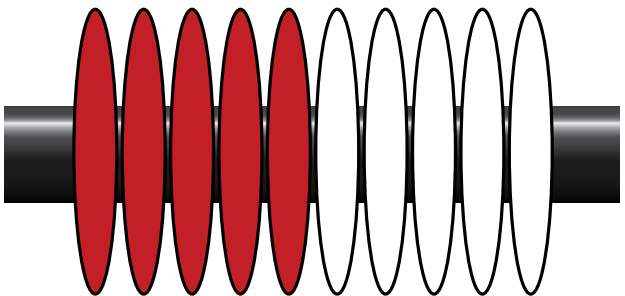
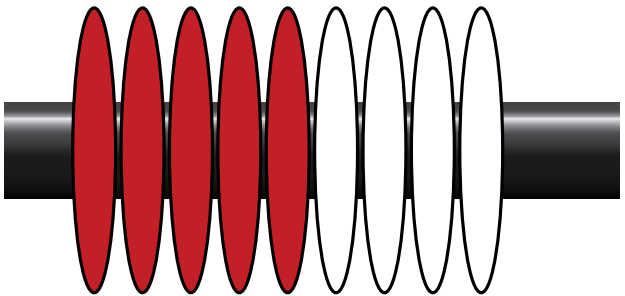
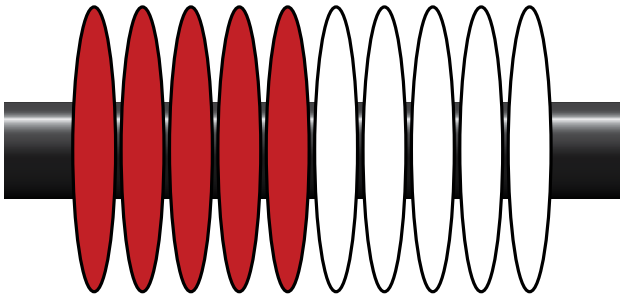



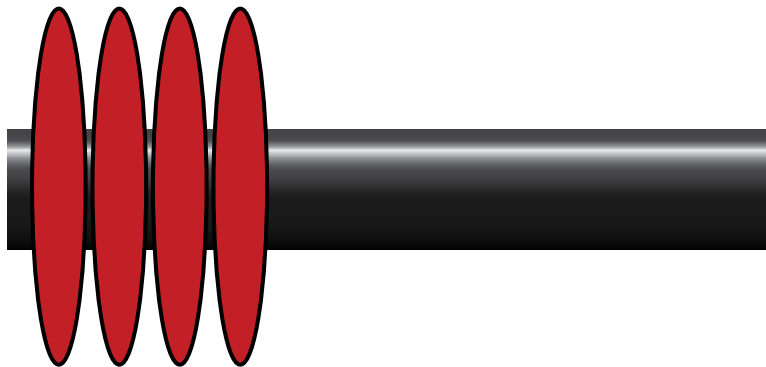
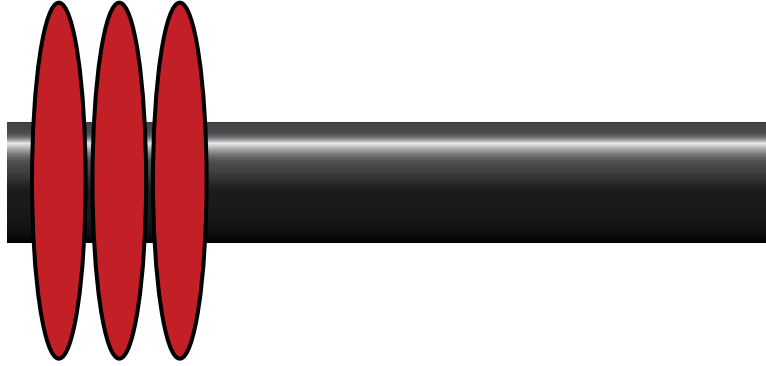

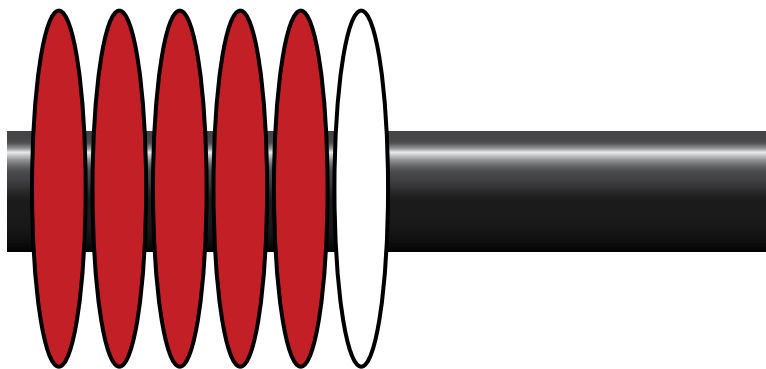
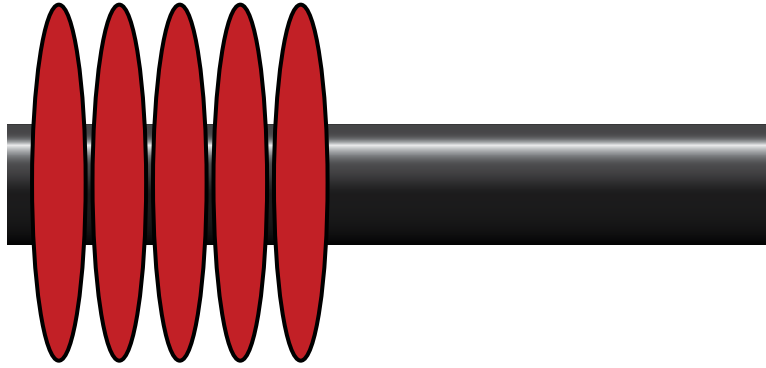

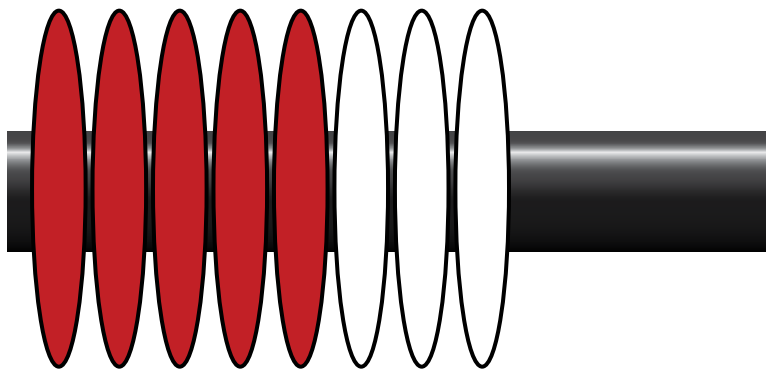
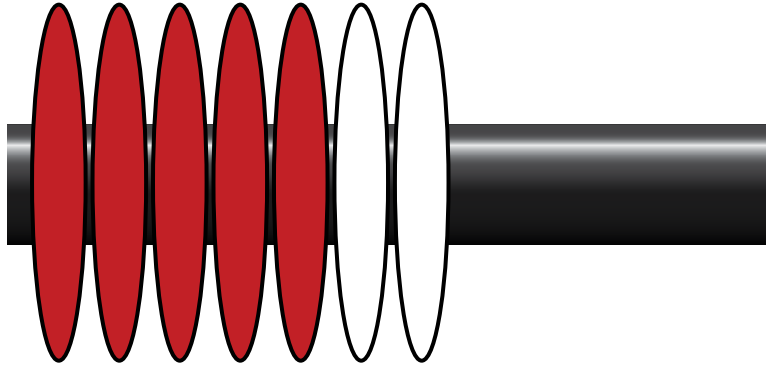

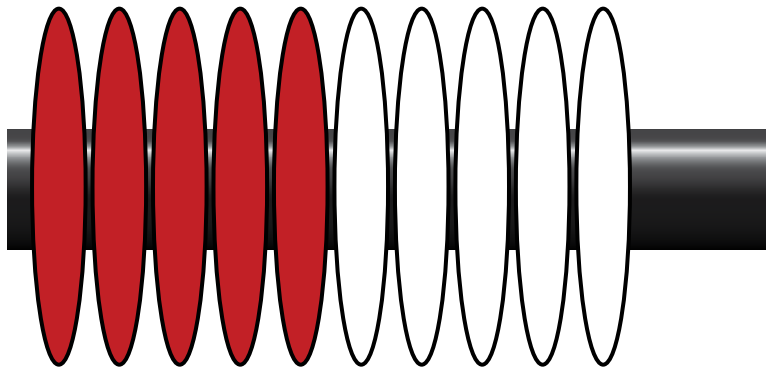
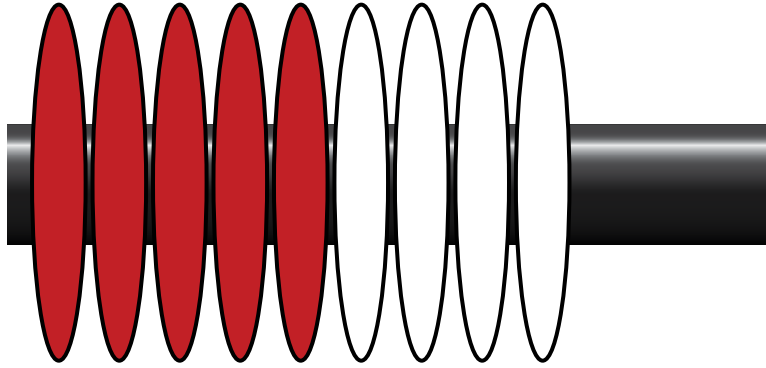

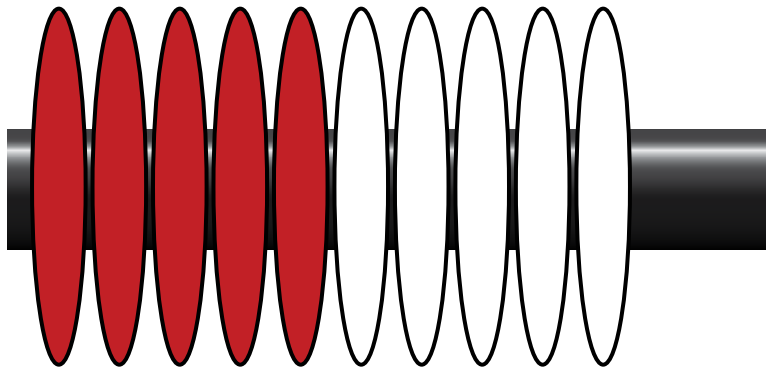
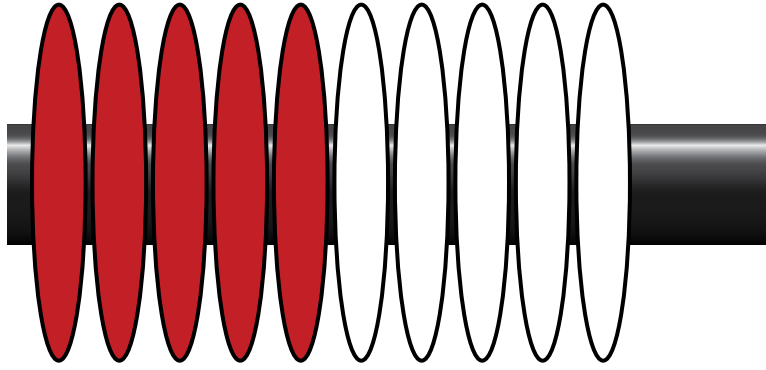

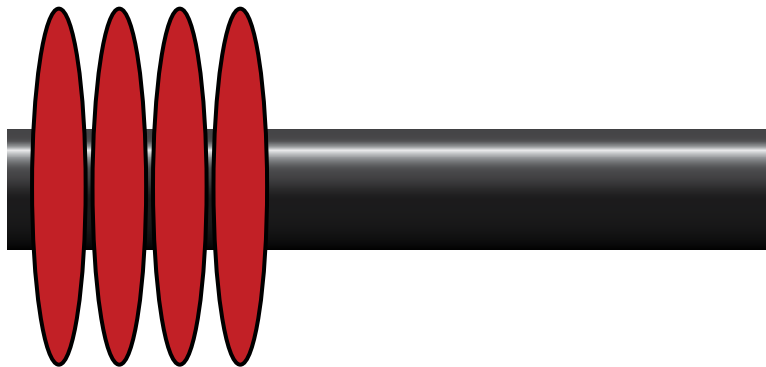
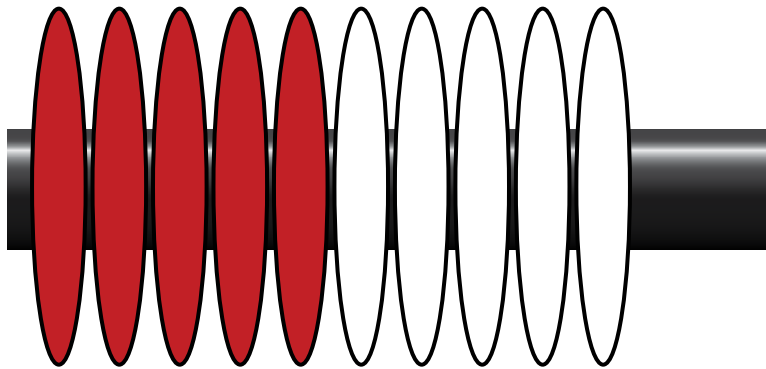
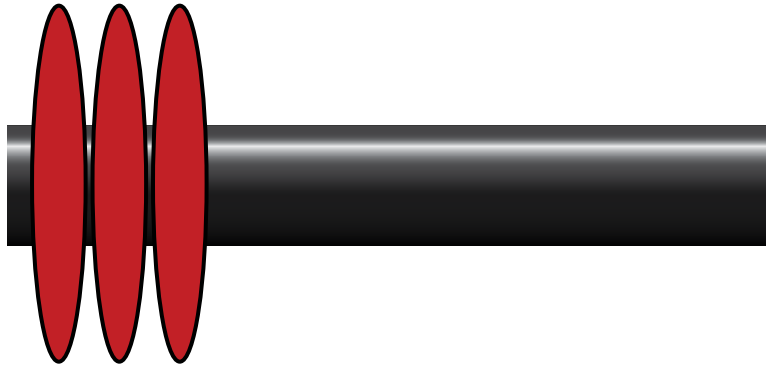
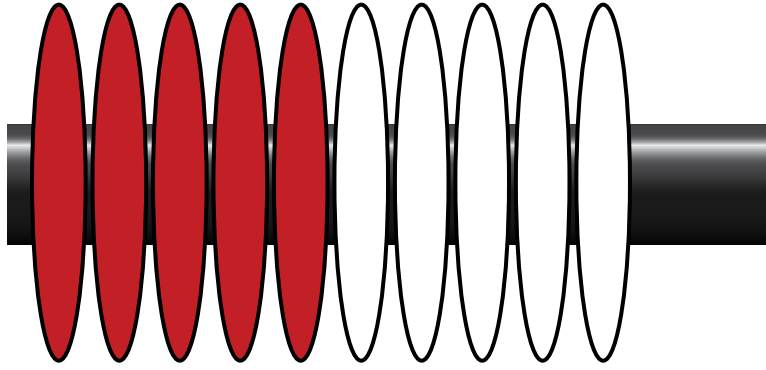

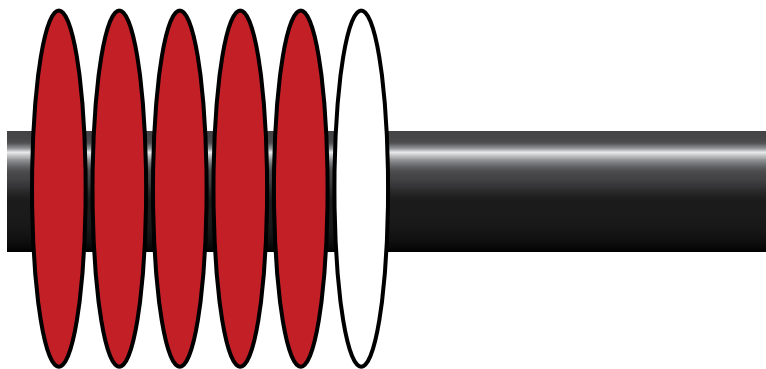
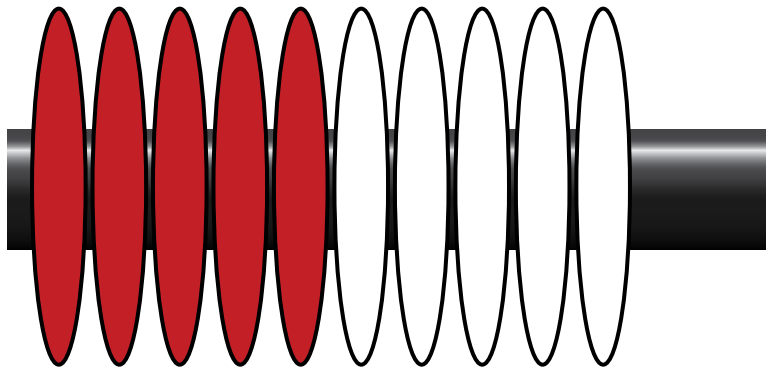
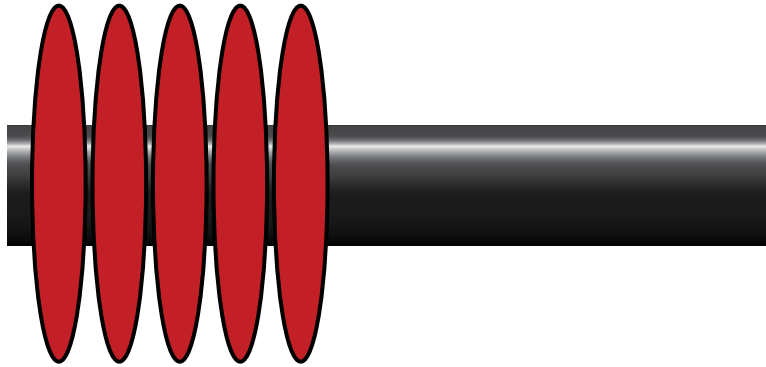
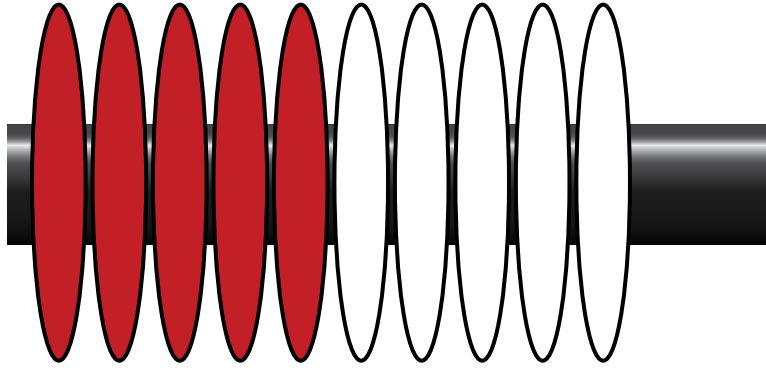

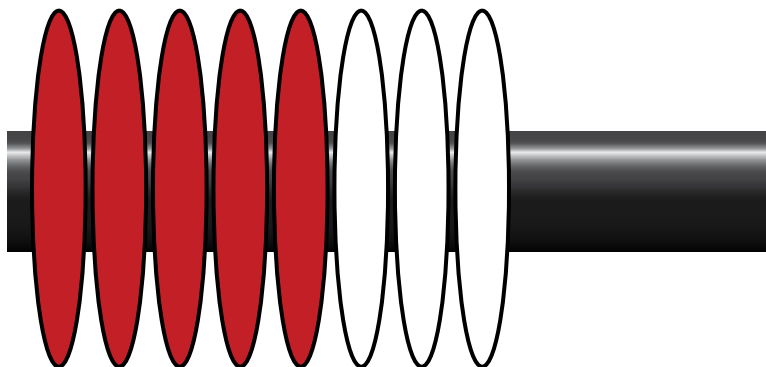
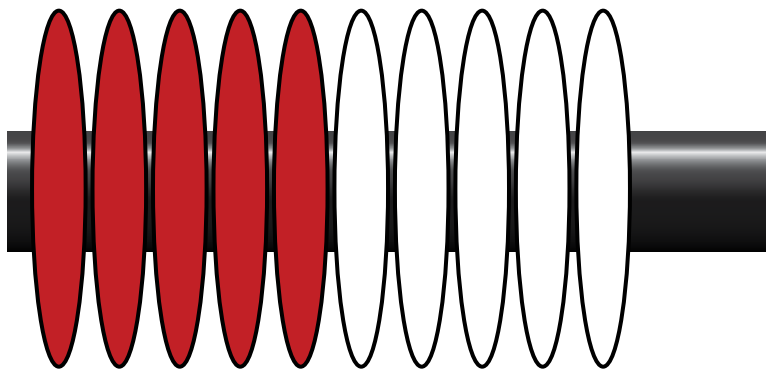
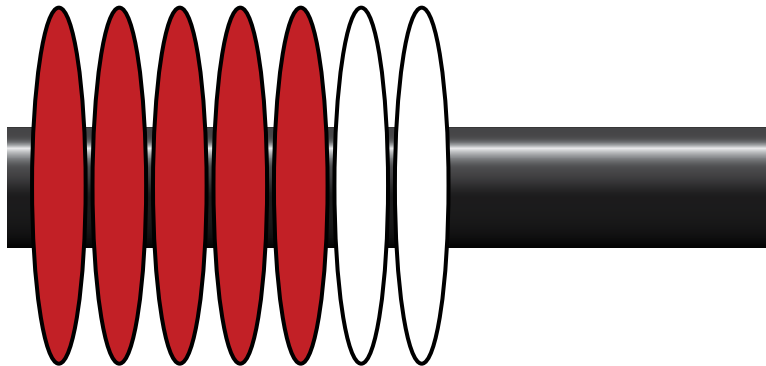
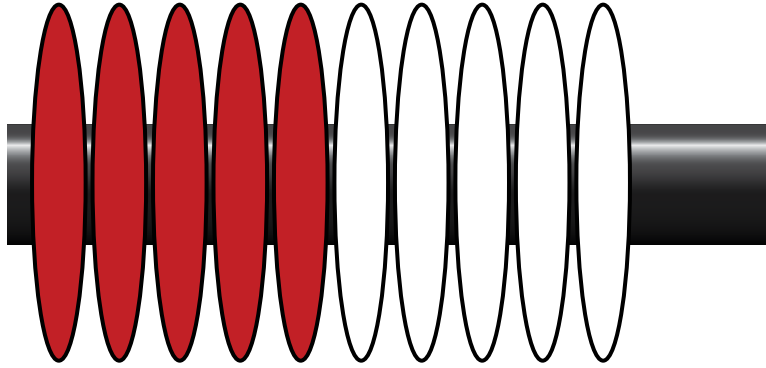

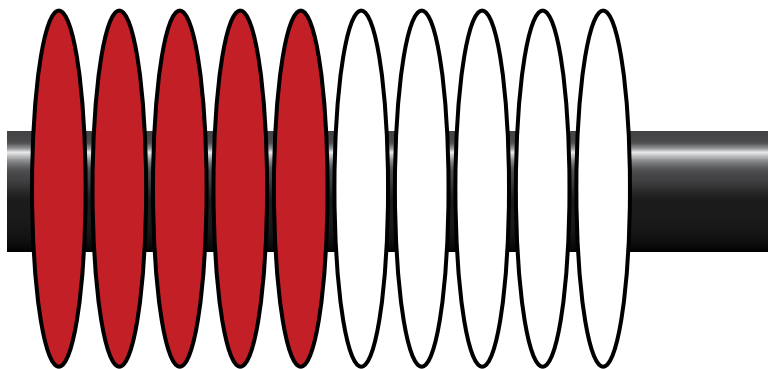
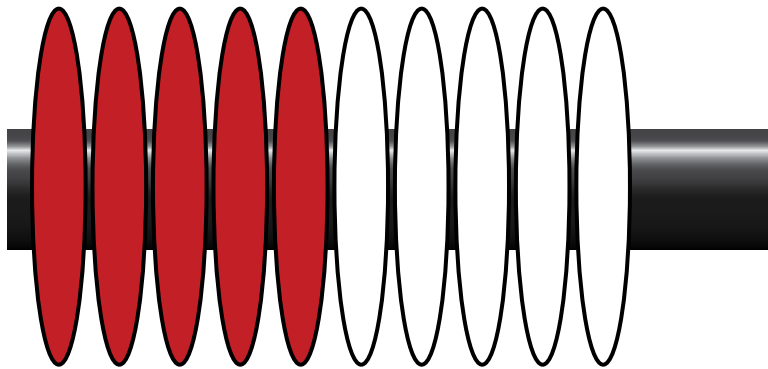
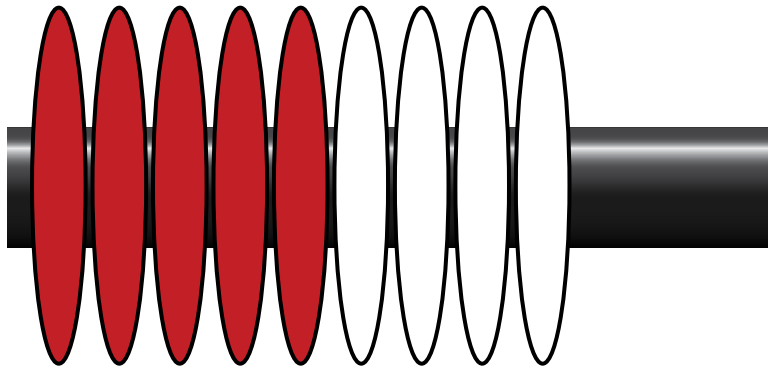
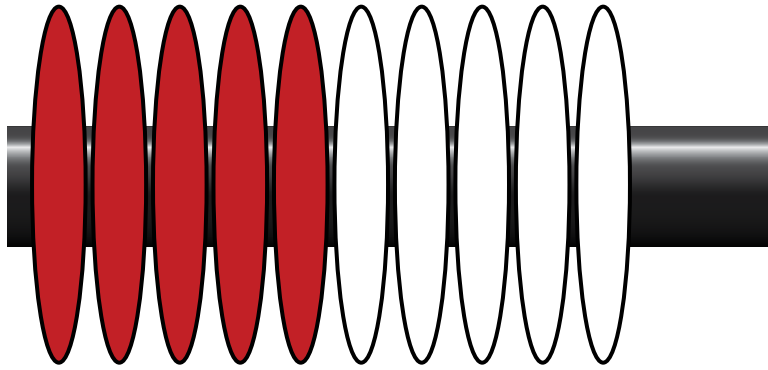



















●	●	●	●	●
●	●			

●	●	●	●	●
●	●	●		















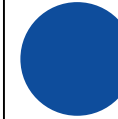



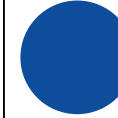



●	●	●	●	●

●	●	●	●	●
●				

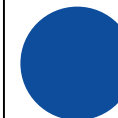



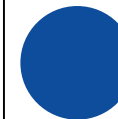









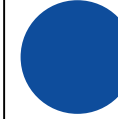





				
				
				



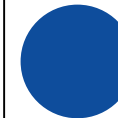



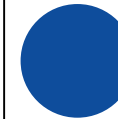

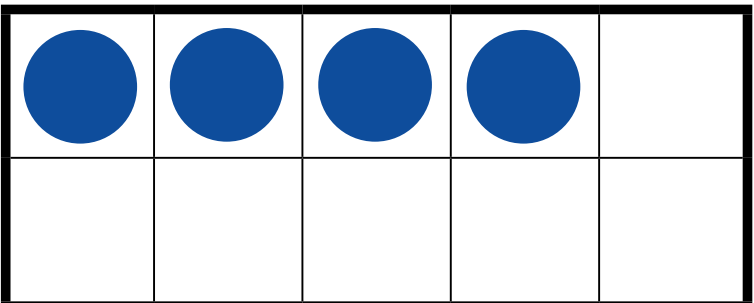
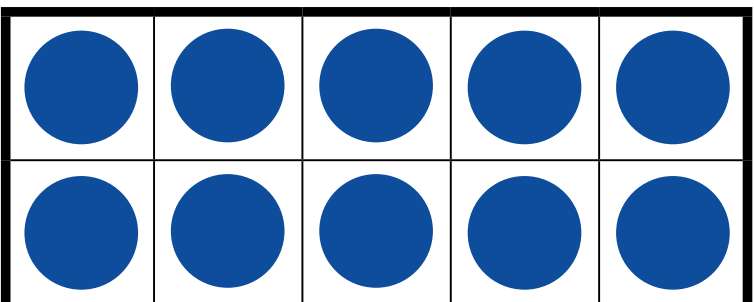
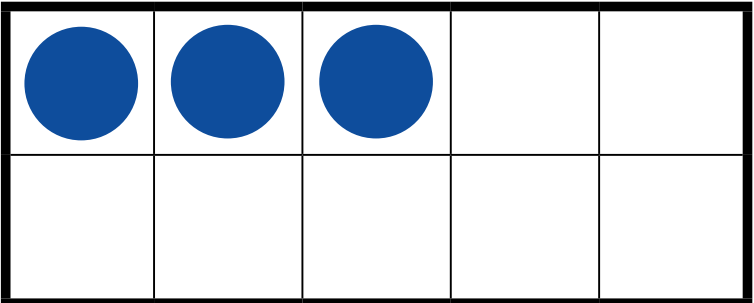
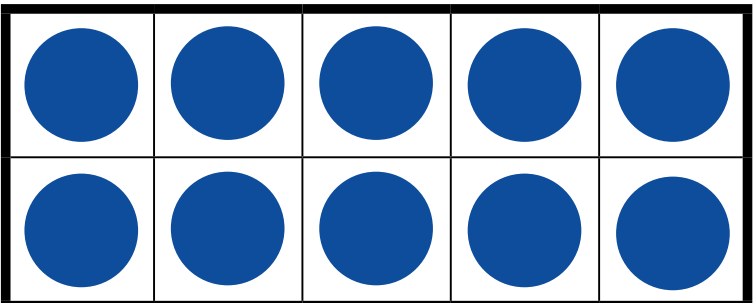
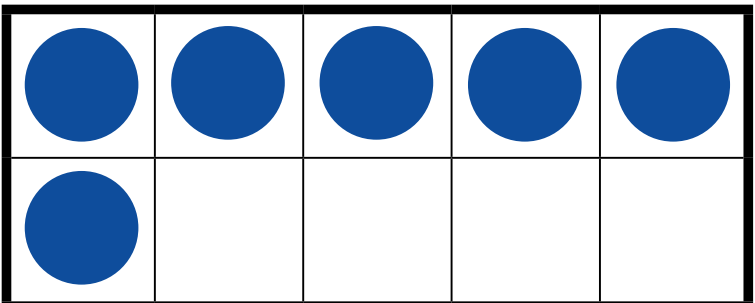
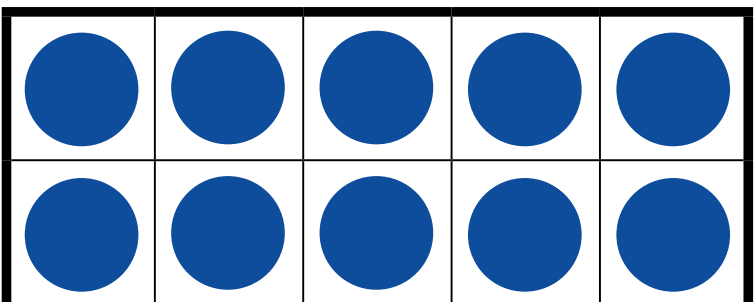
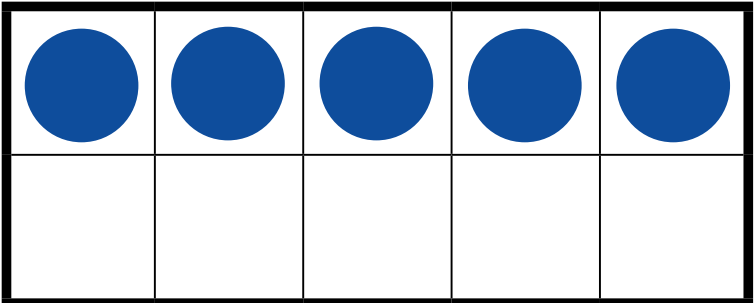
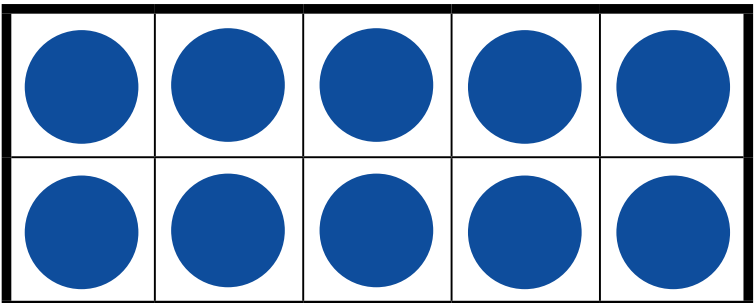

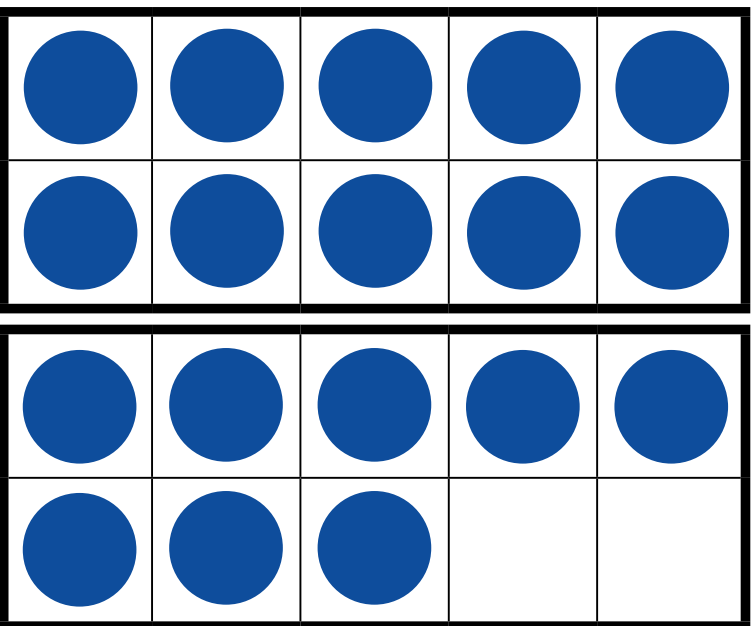
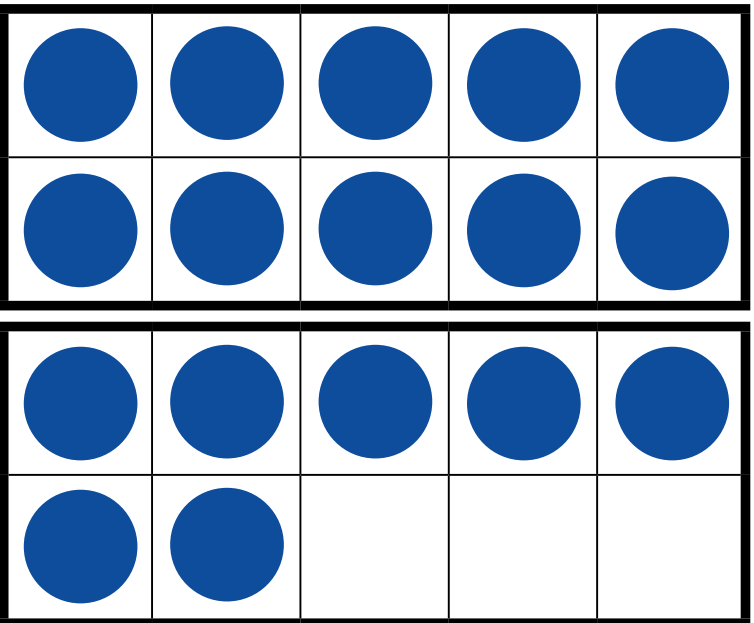
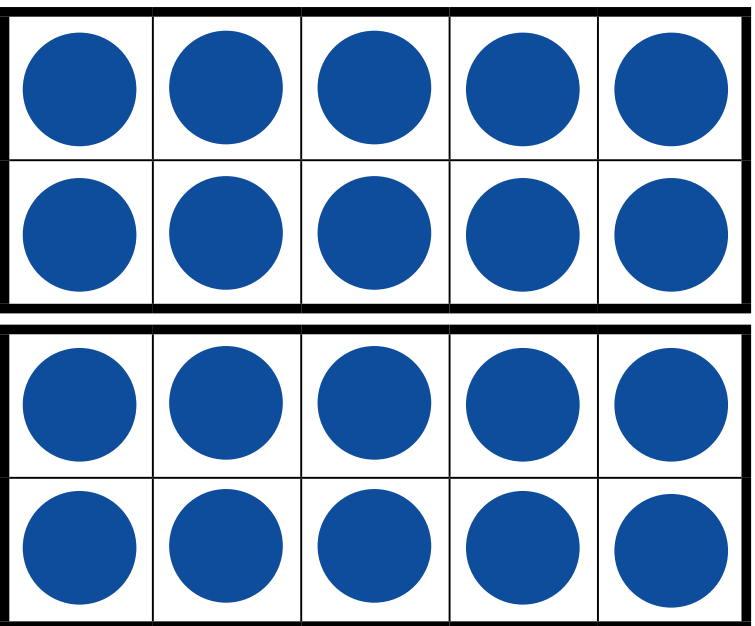
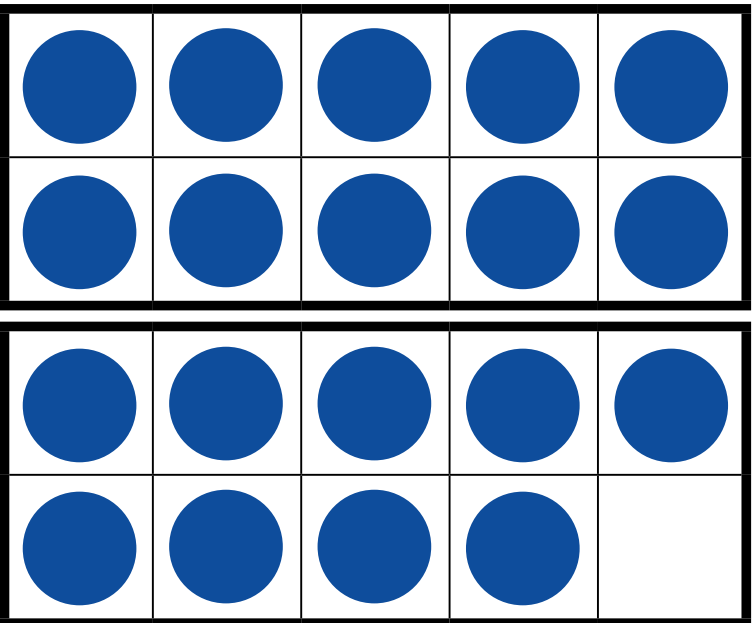

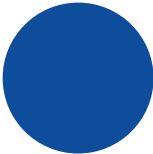

				





				



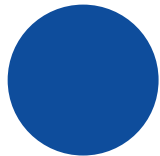
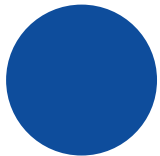
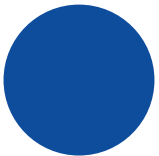

				

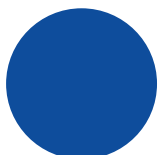

				



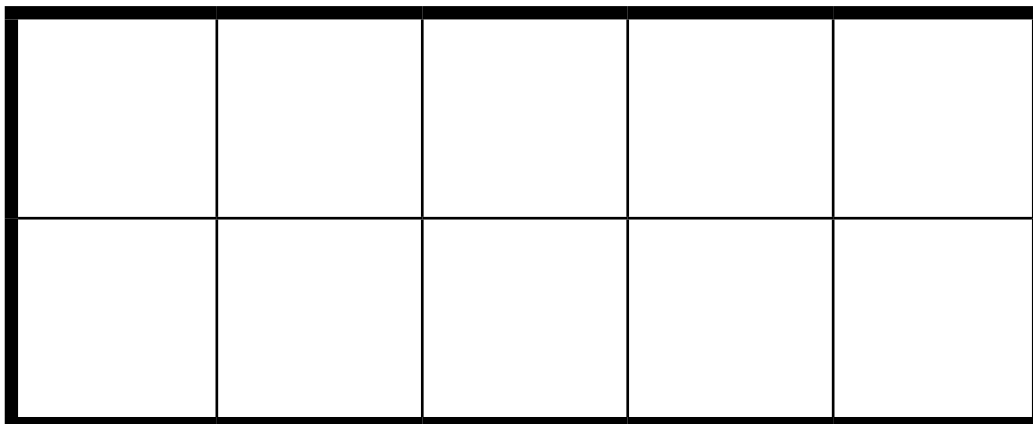
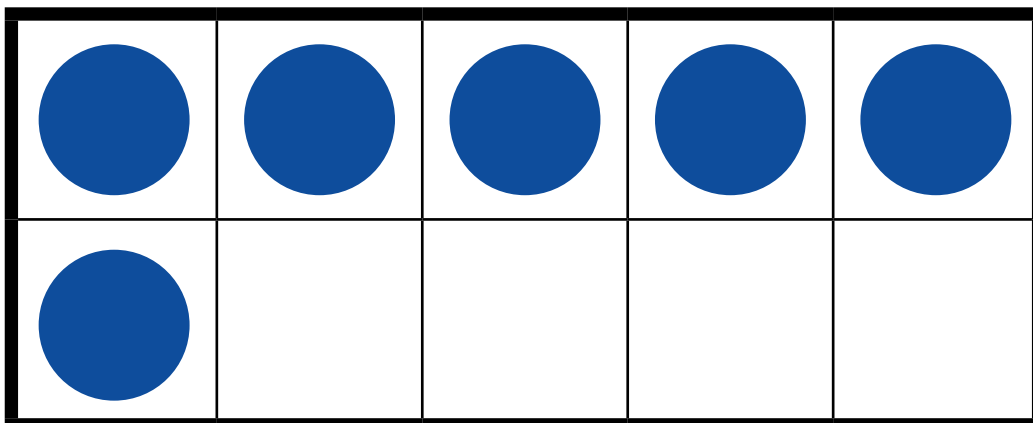
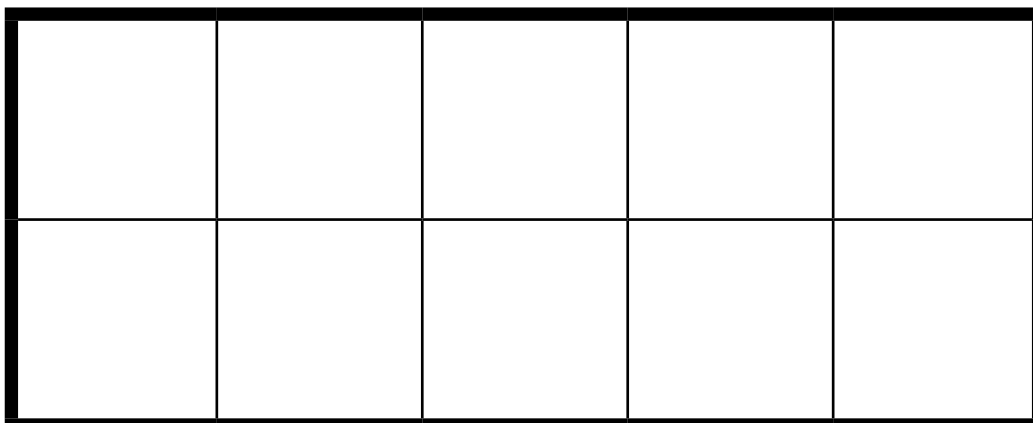
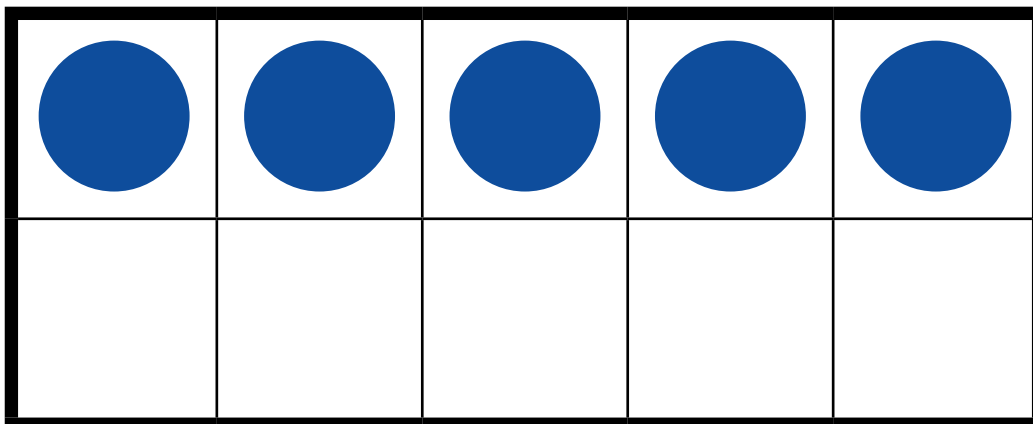

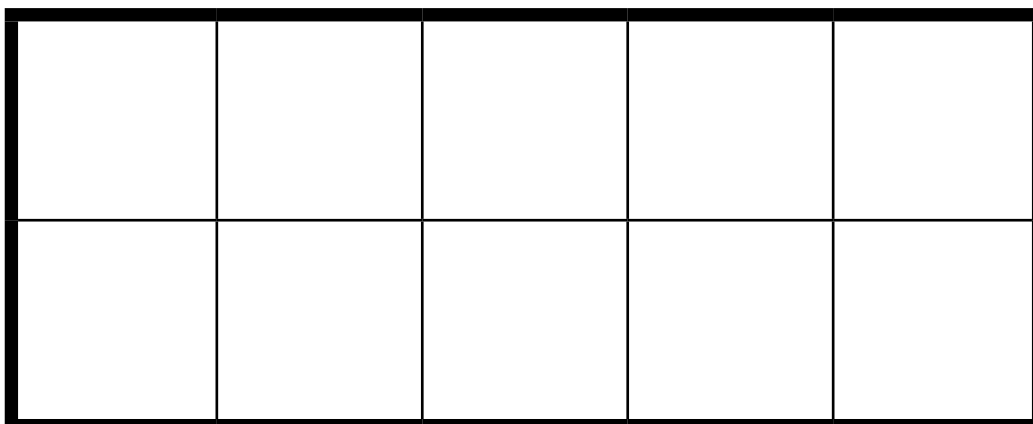
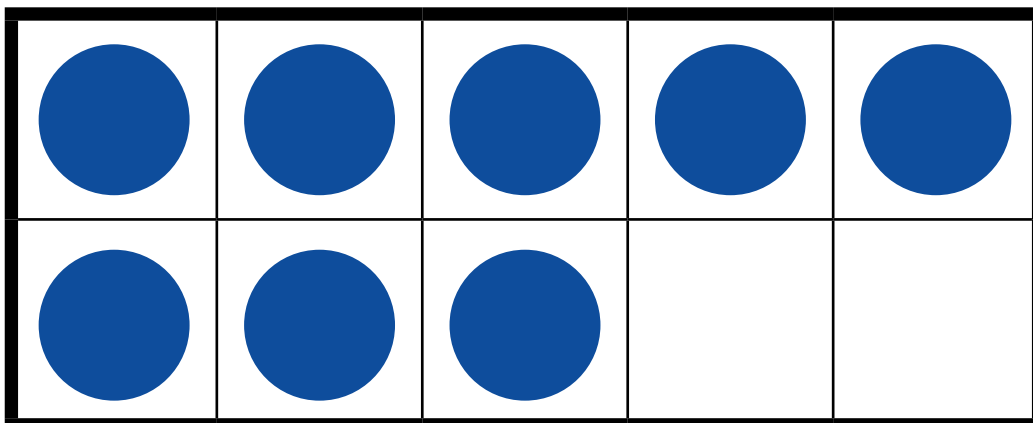
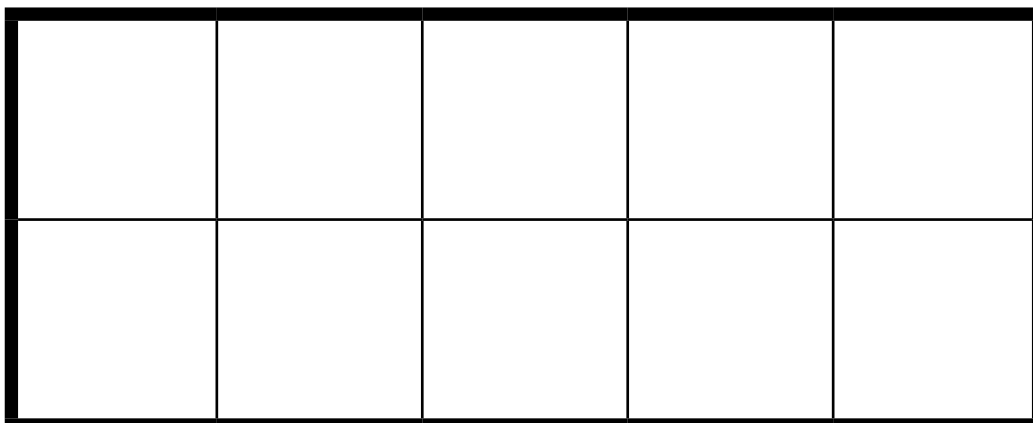
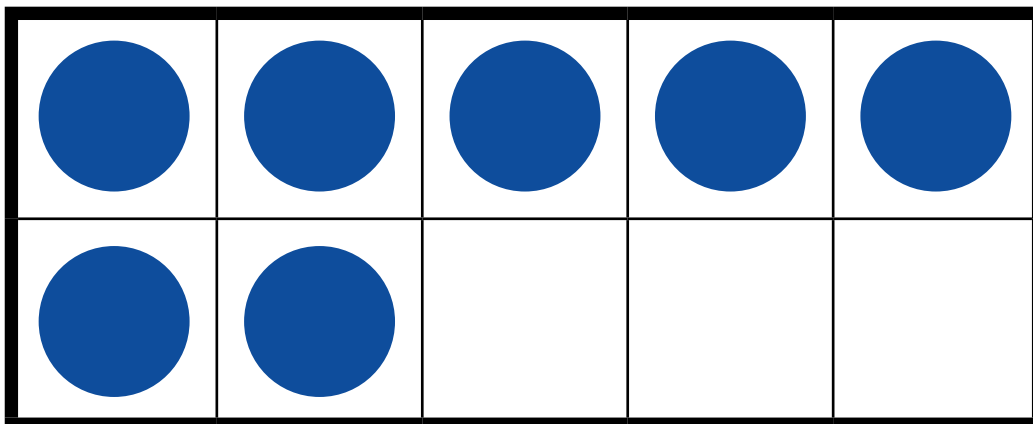

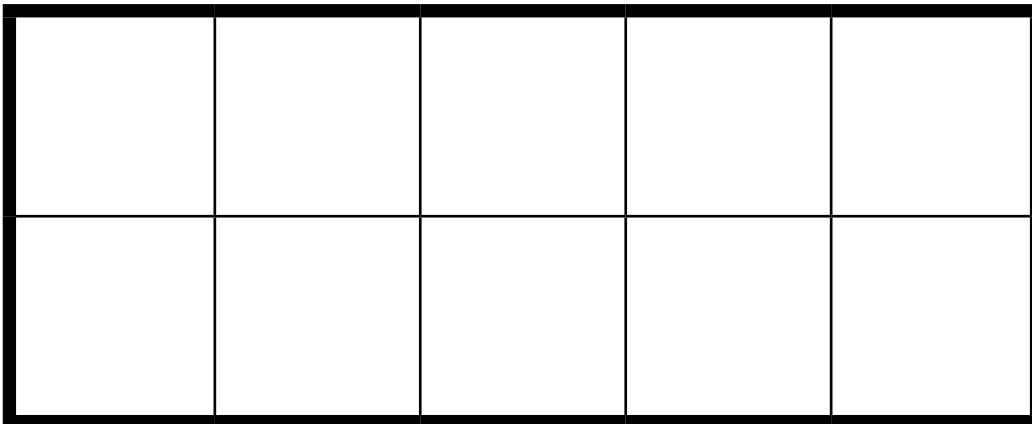
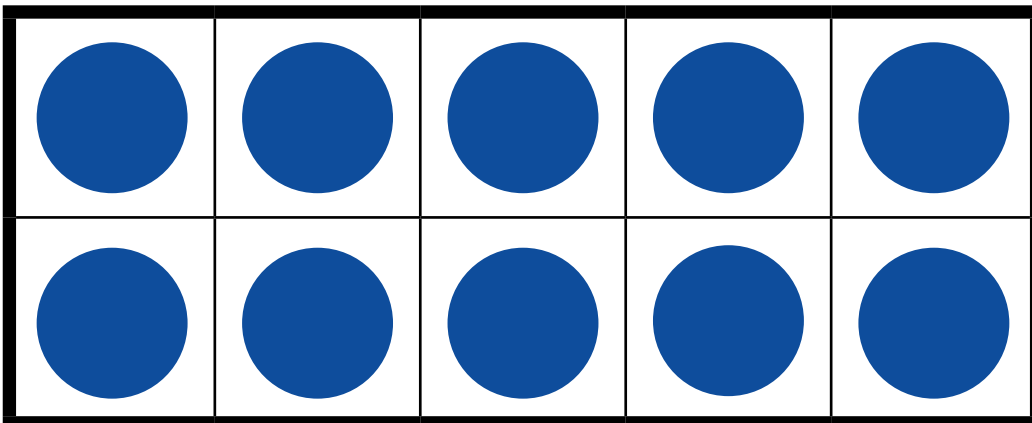
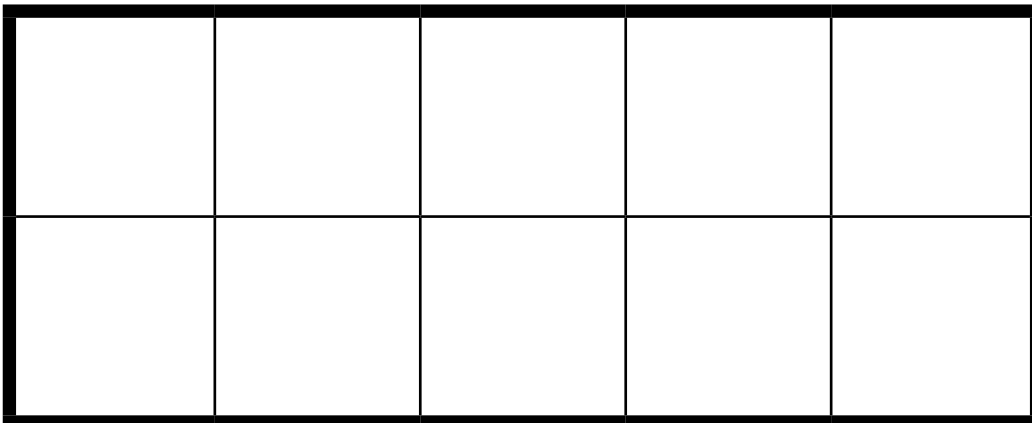
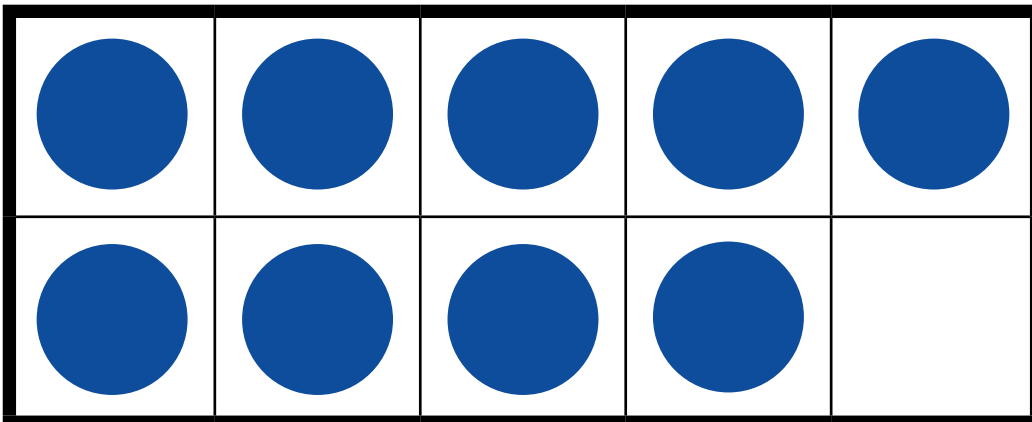

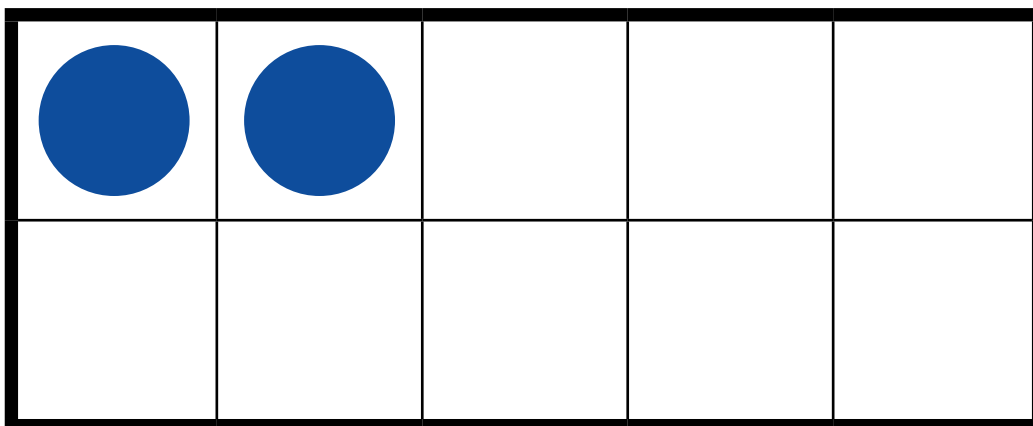
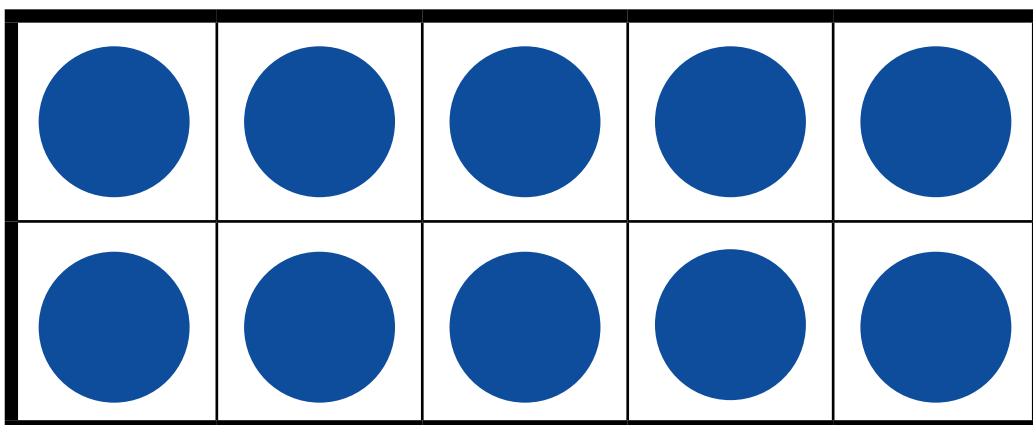
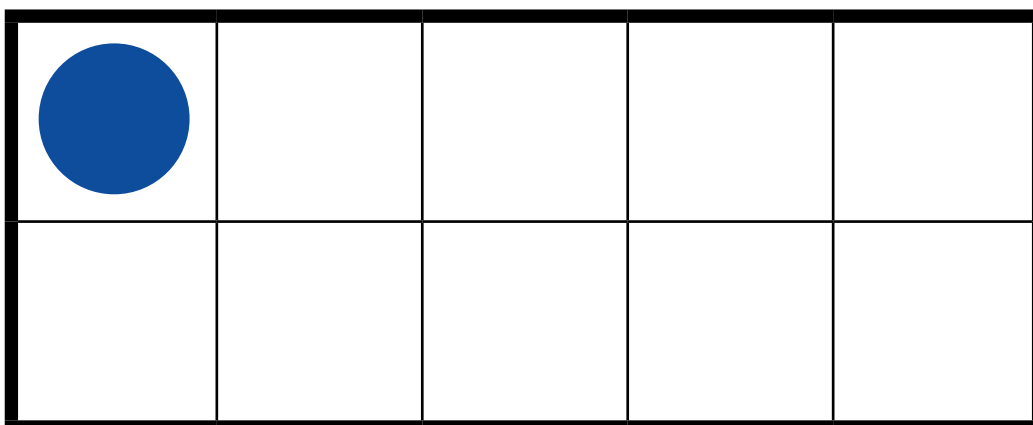
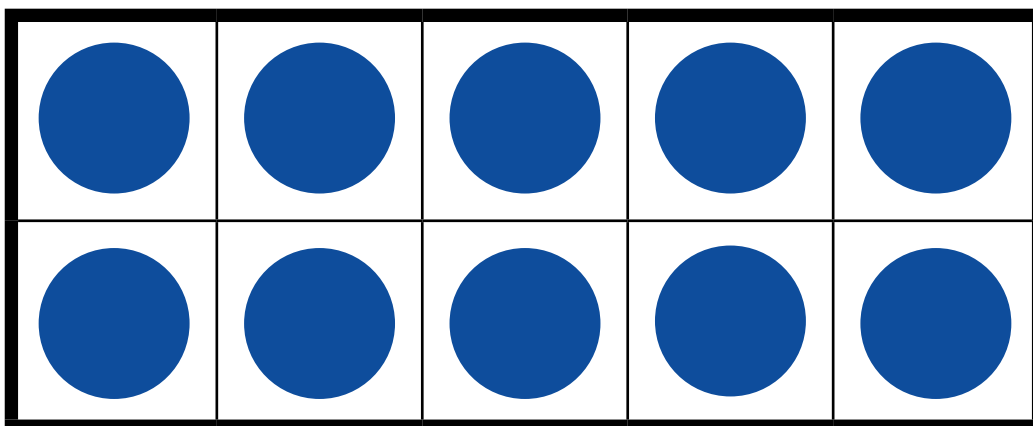

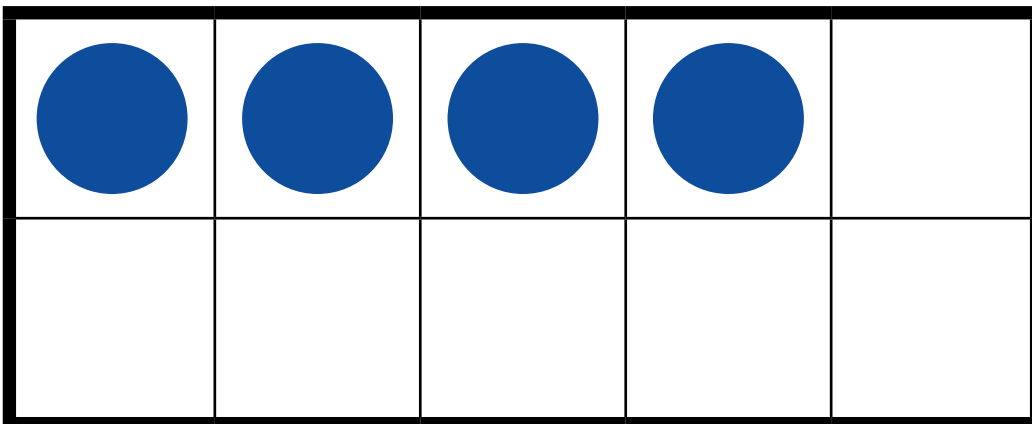
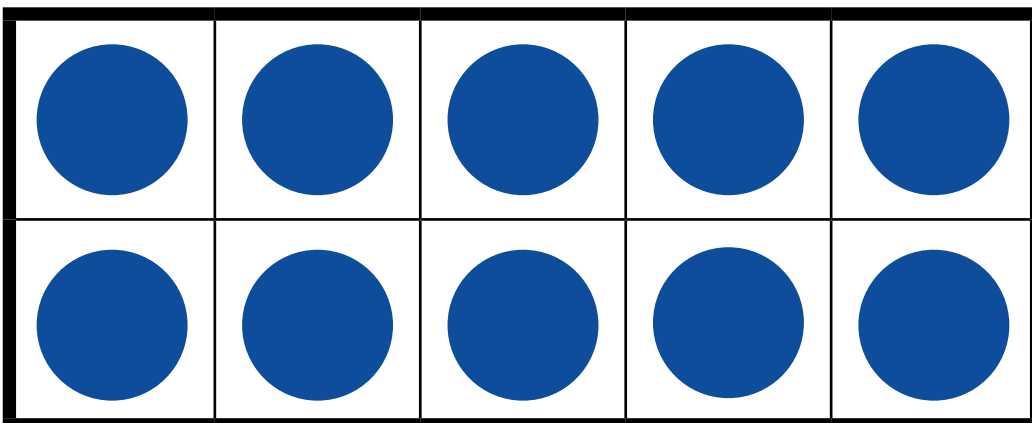
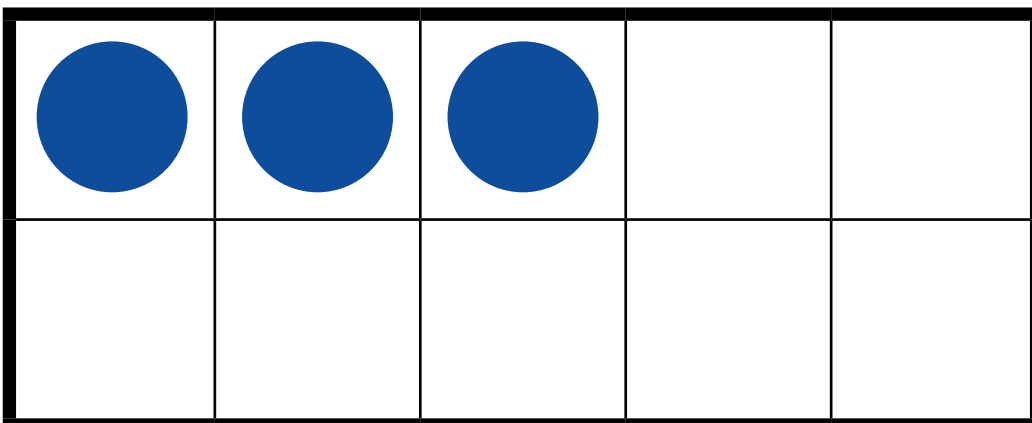
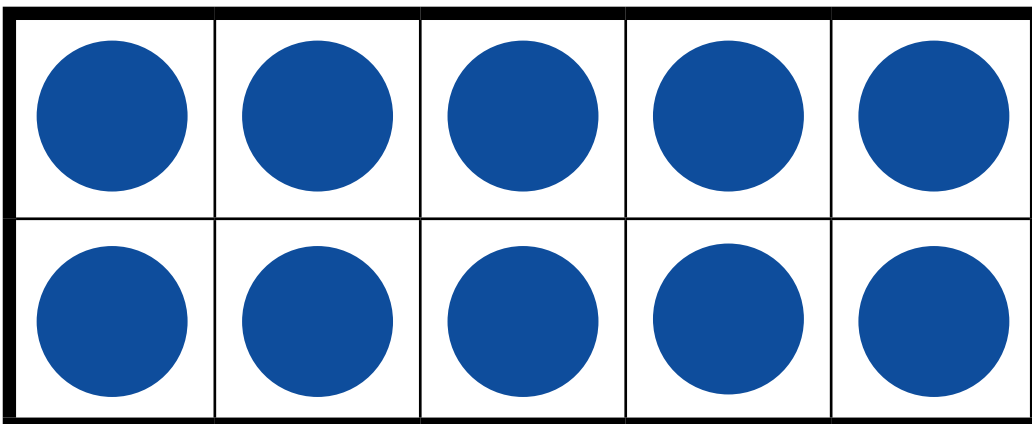

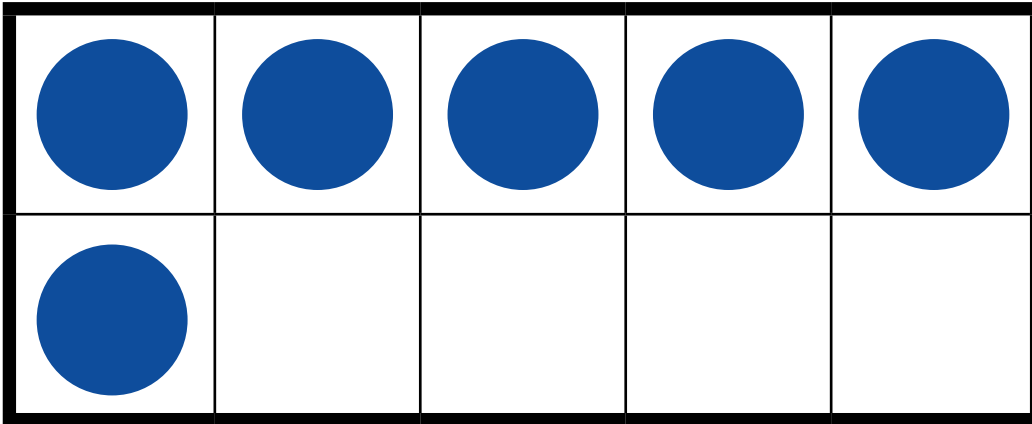
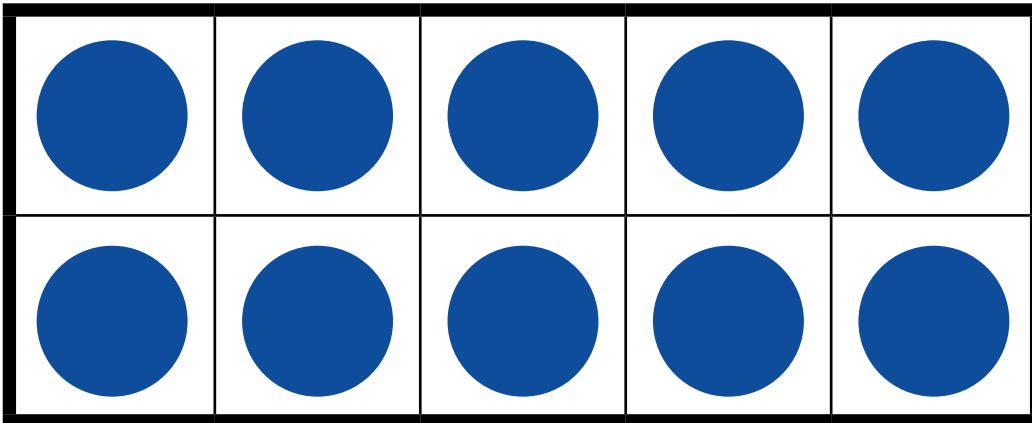
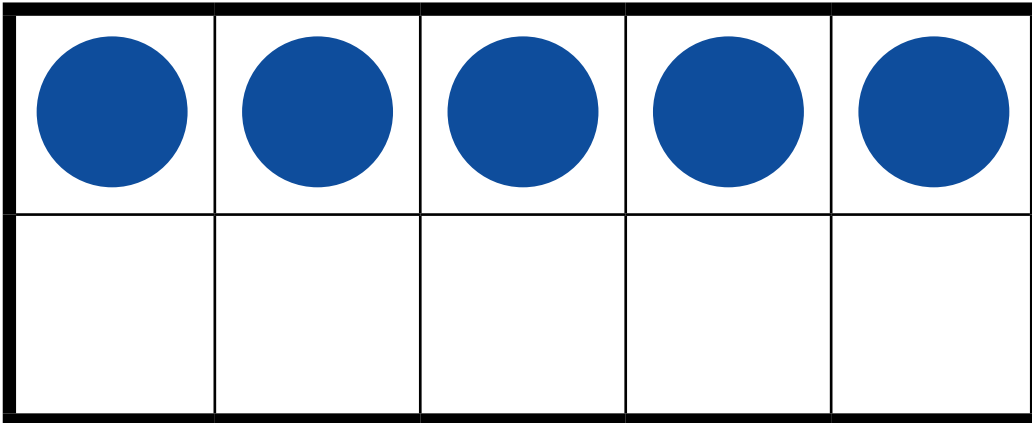
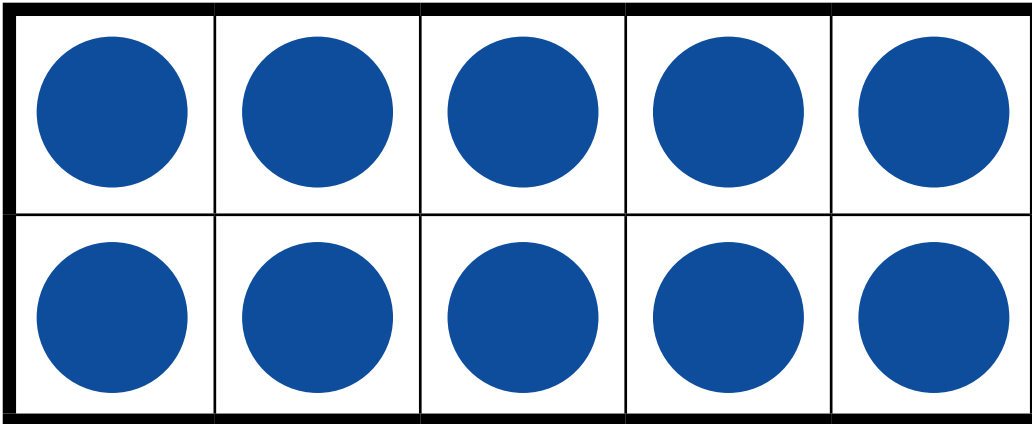

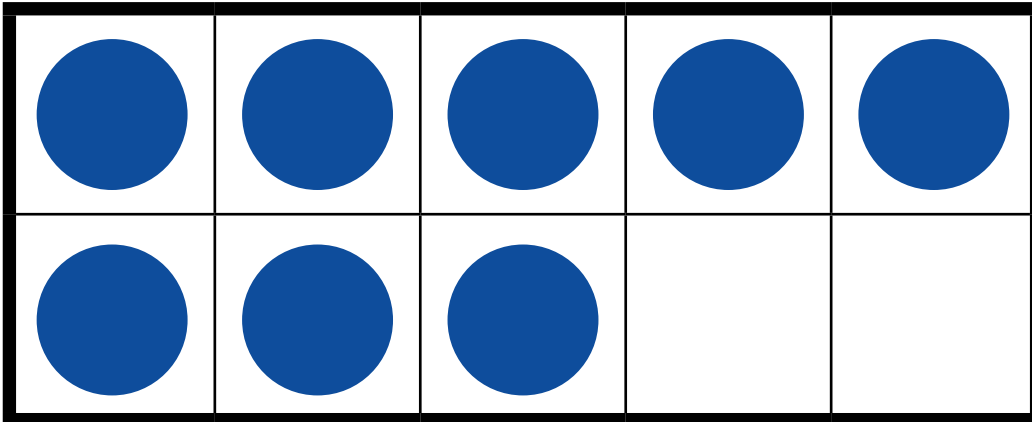
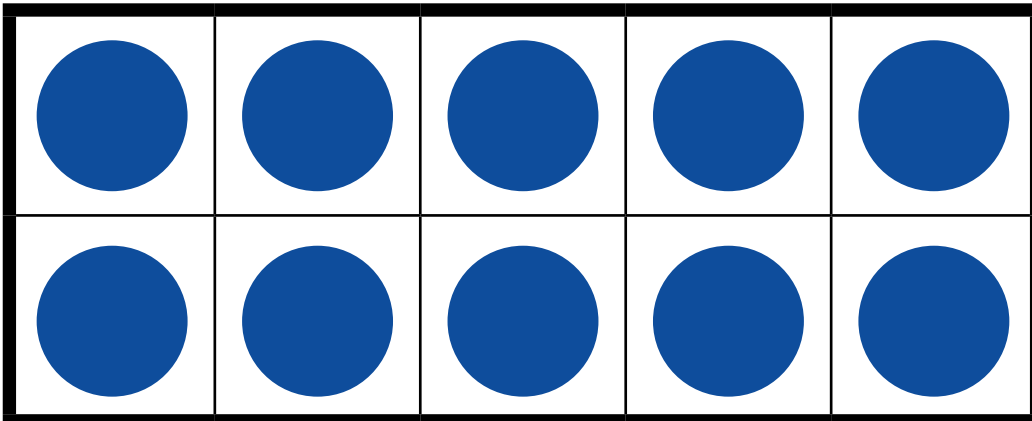
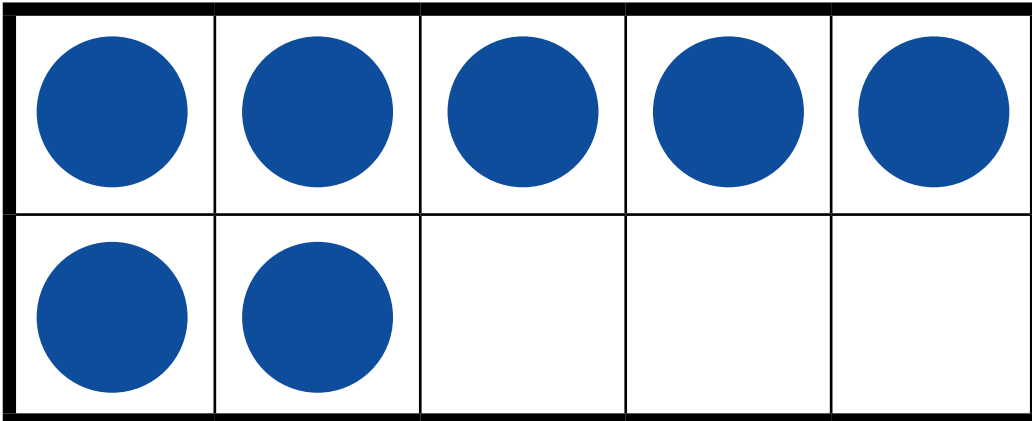
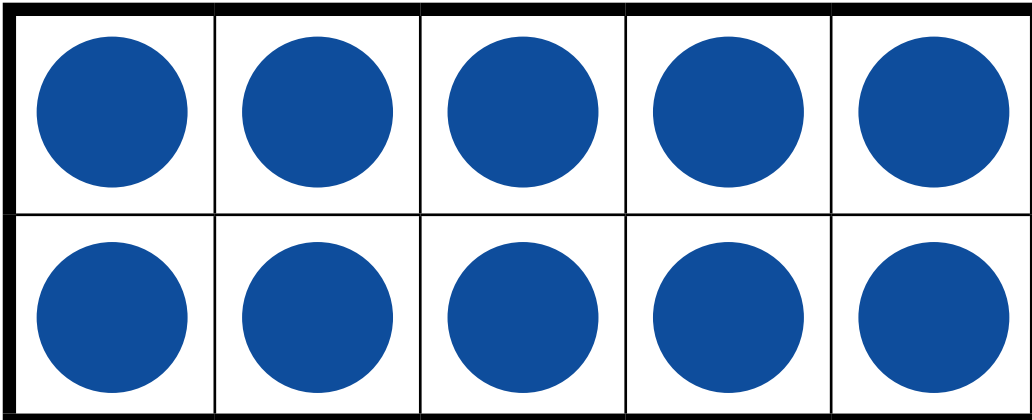

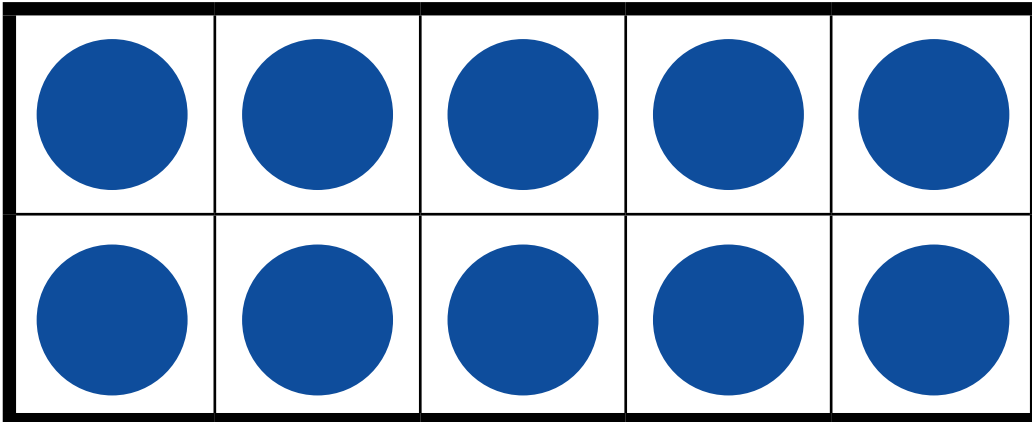
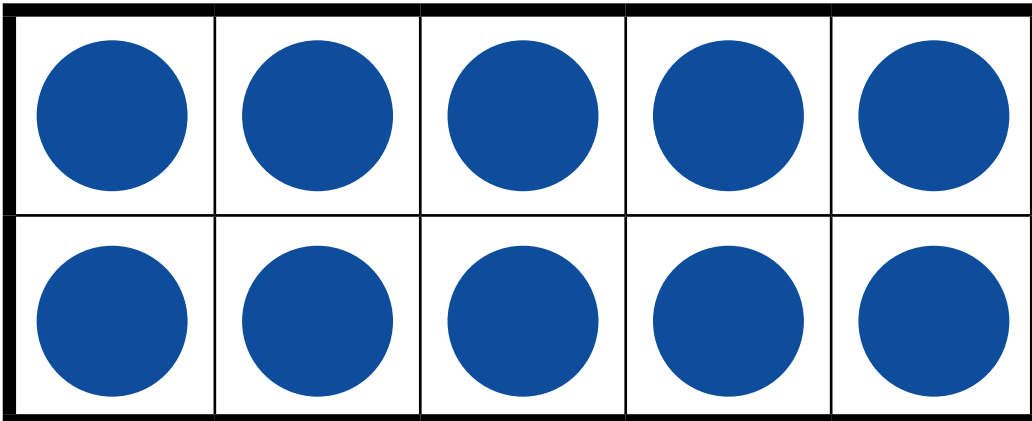
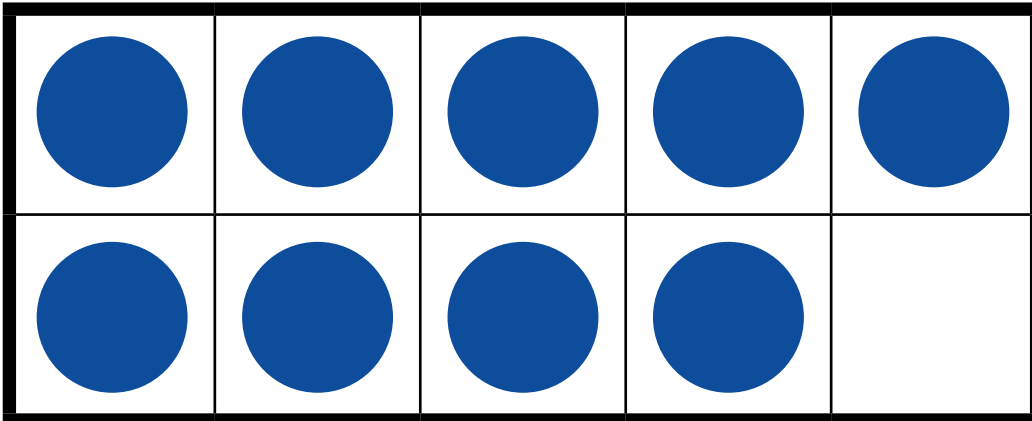
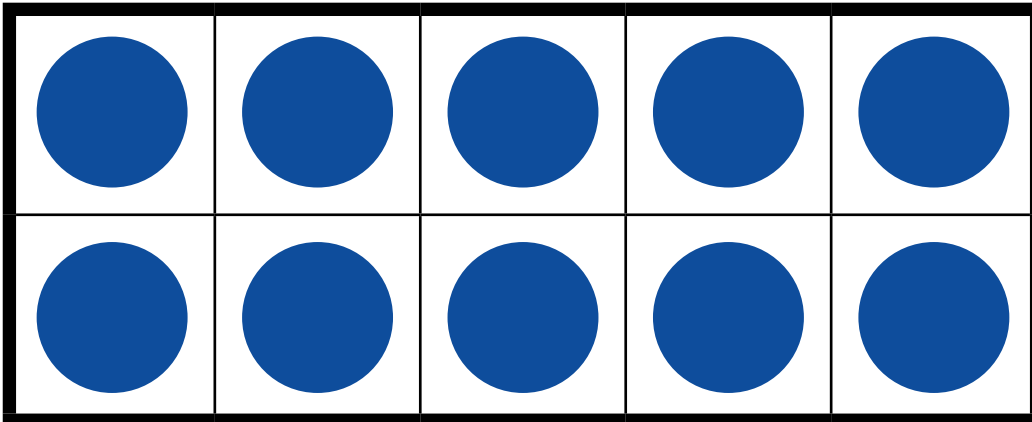

Doigts de deux paires de mains (1 à 20)

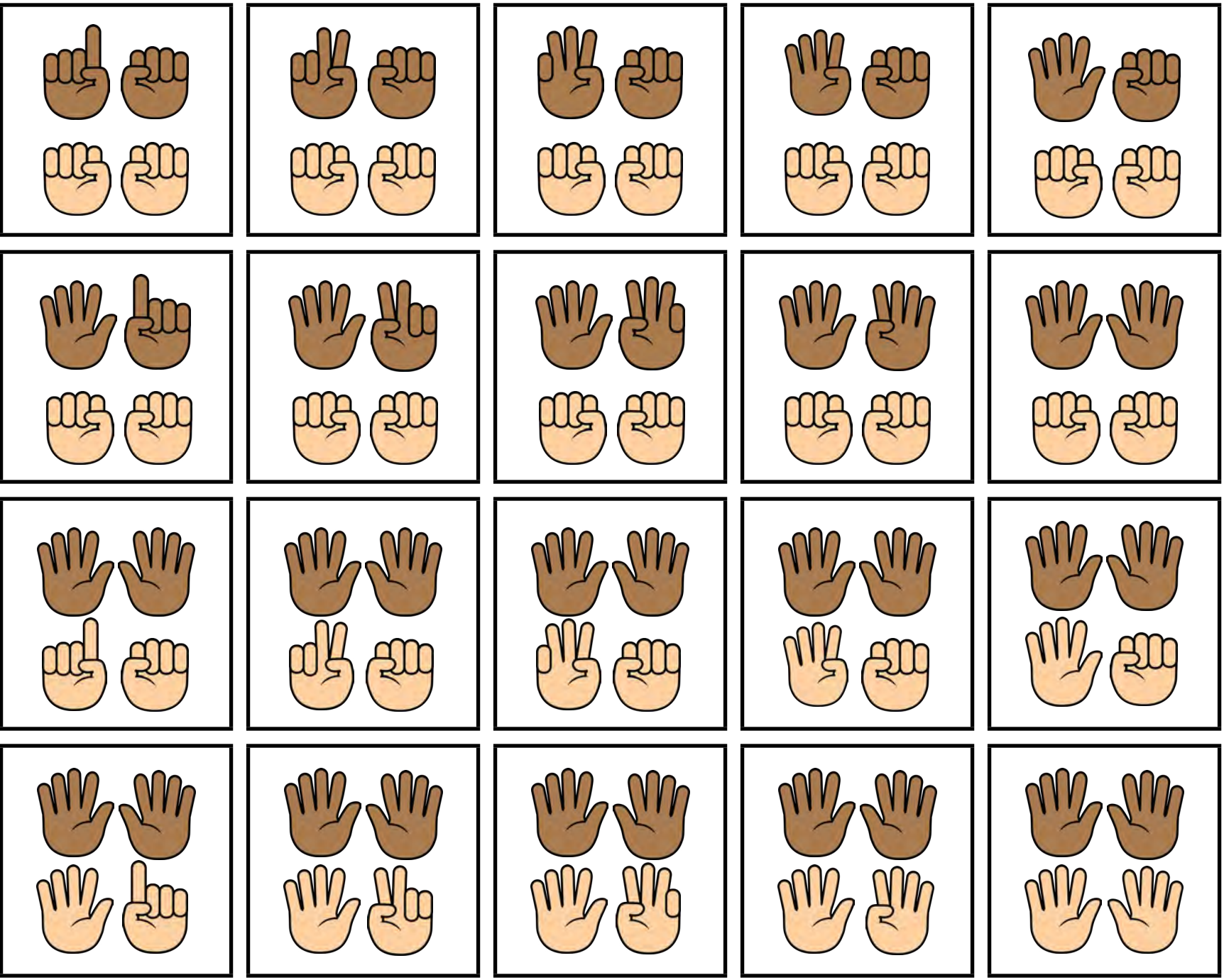

Cartes de représentations imagée des nombres jusqu'à 20

Doigts (0 à 20) avec nombres

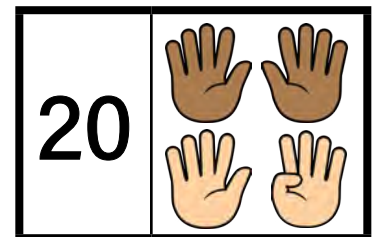
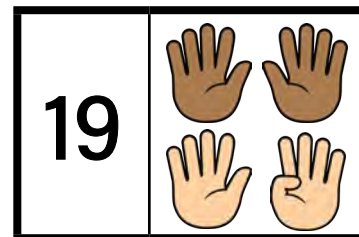
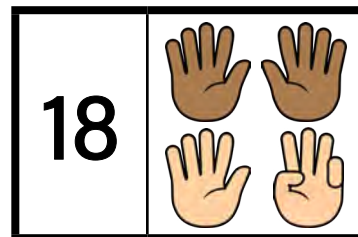
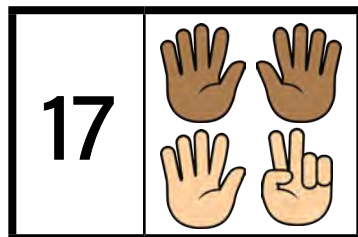
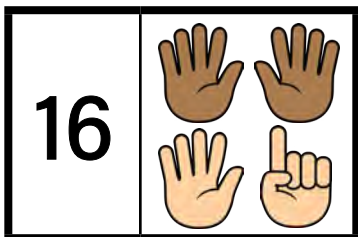
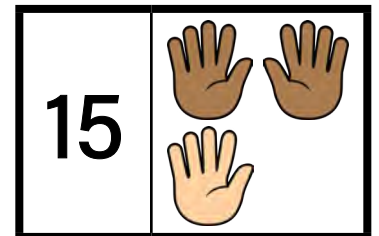
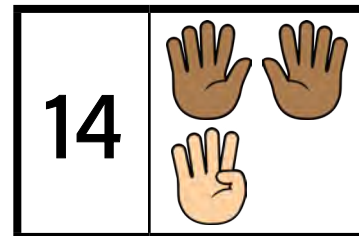
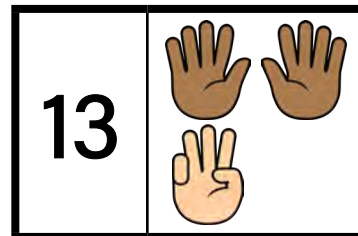
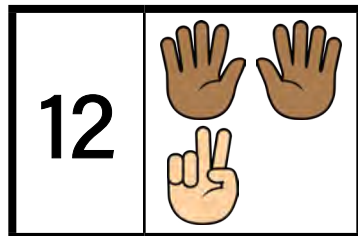
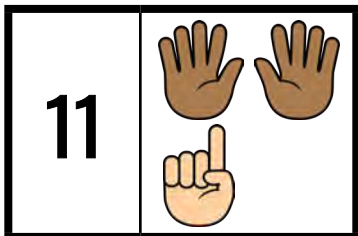
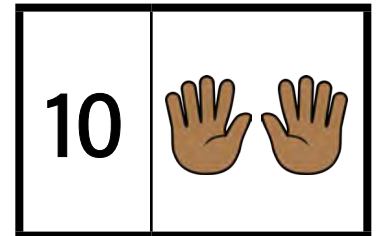
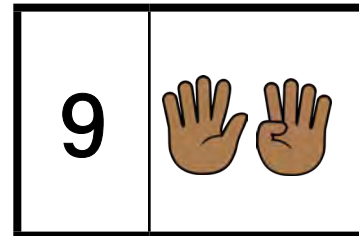
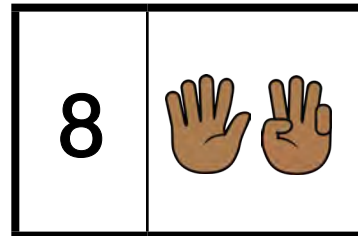
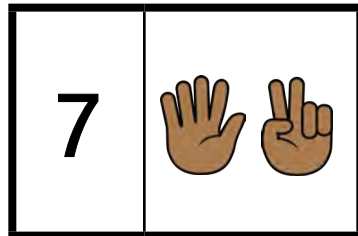
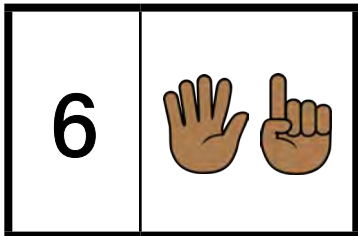
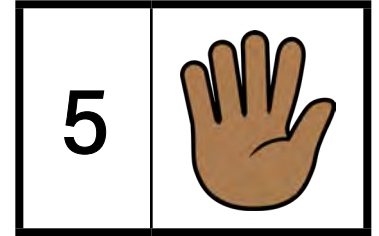
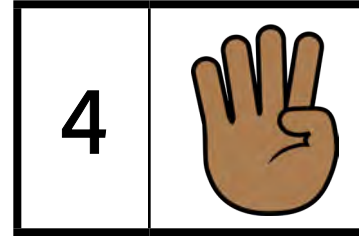
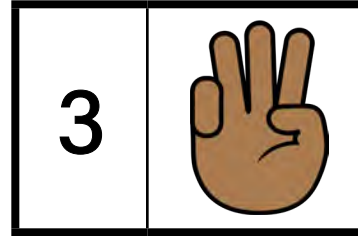
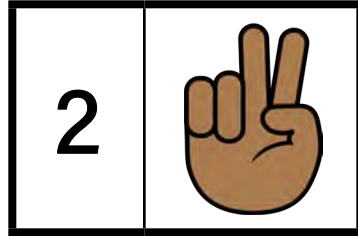
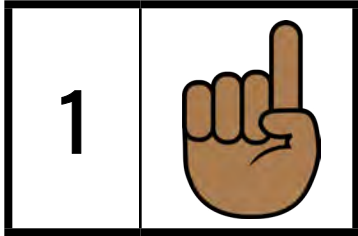
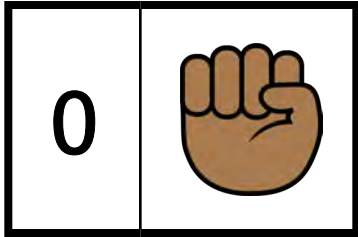

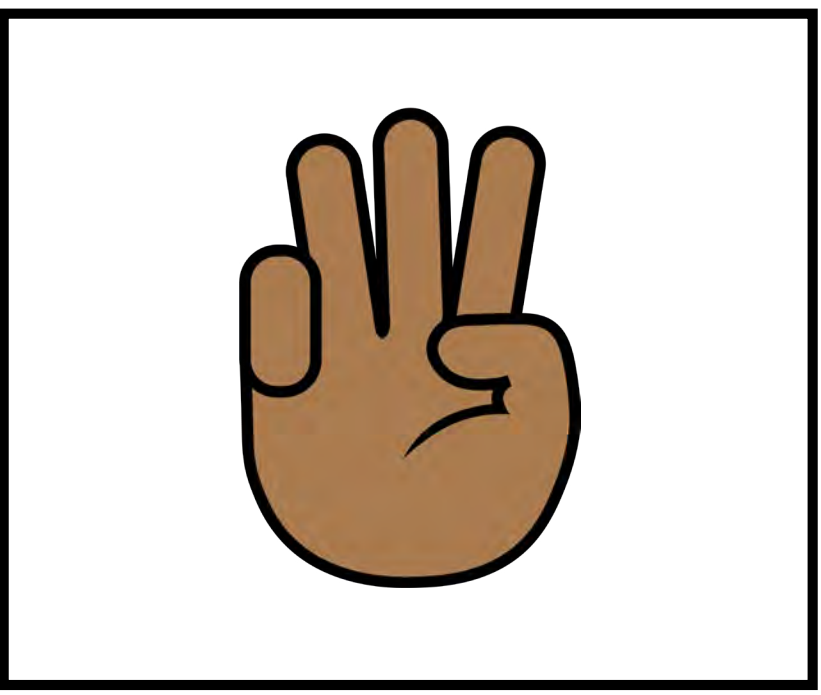
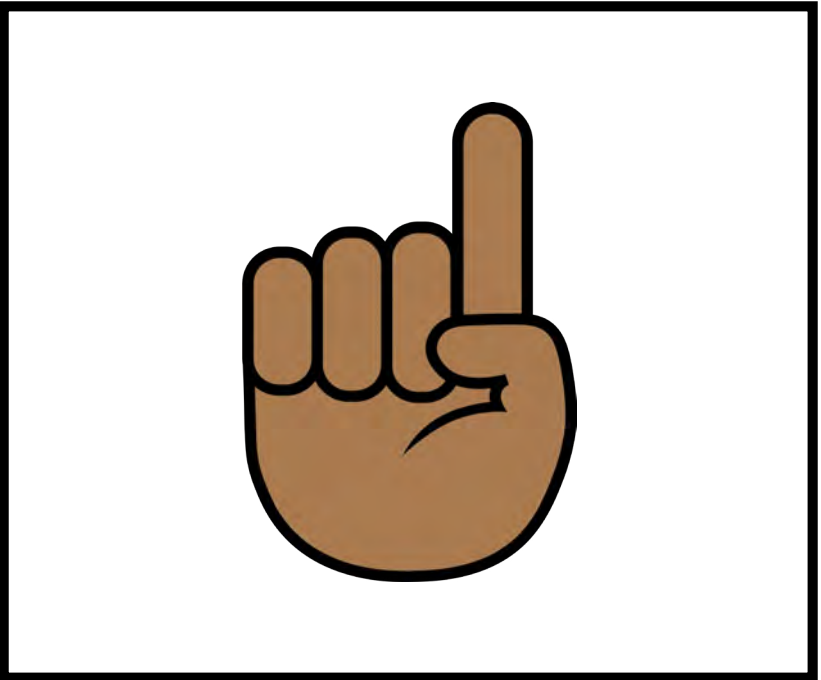
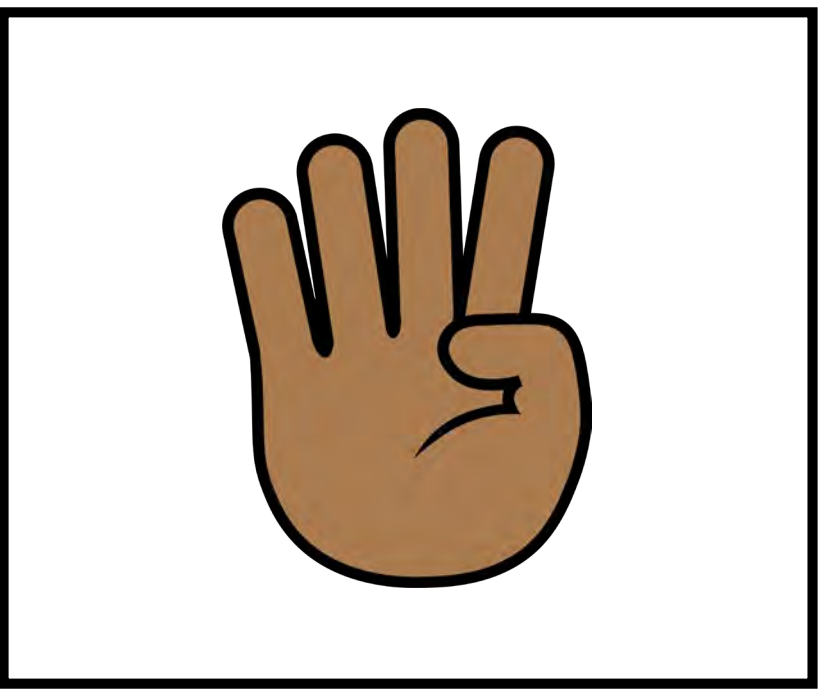
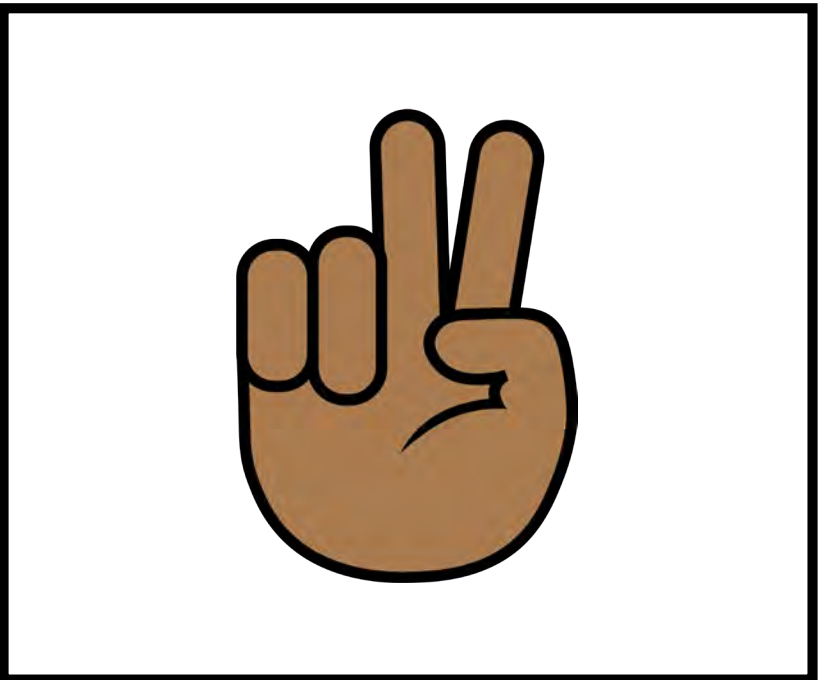

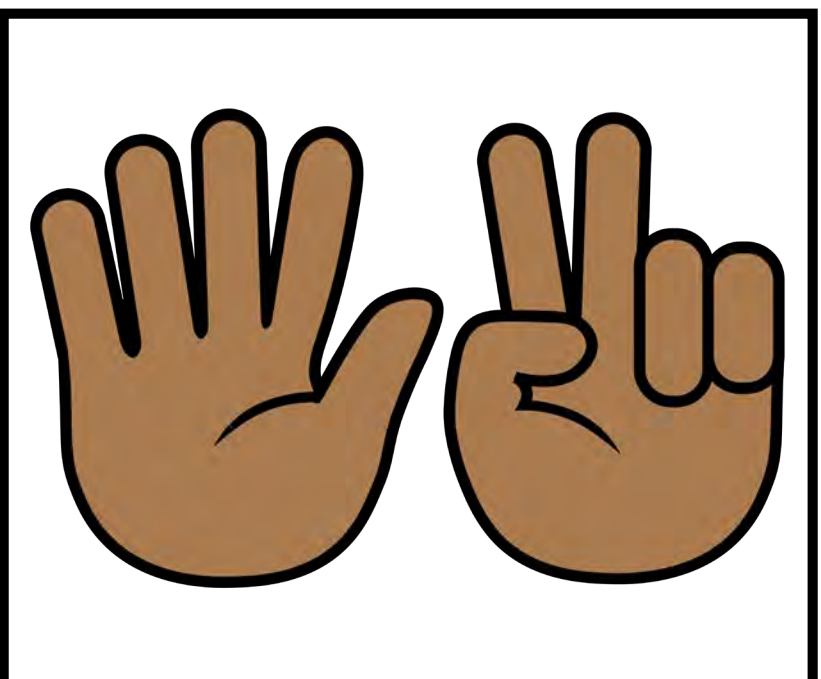
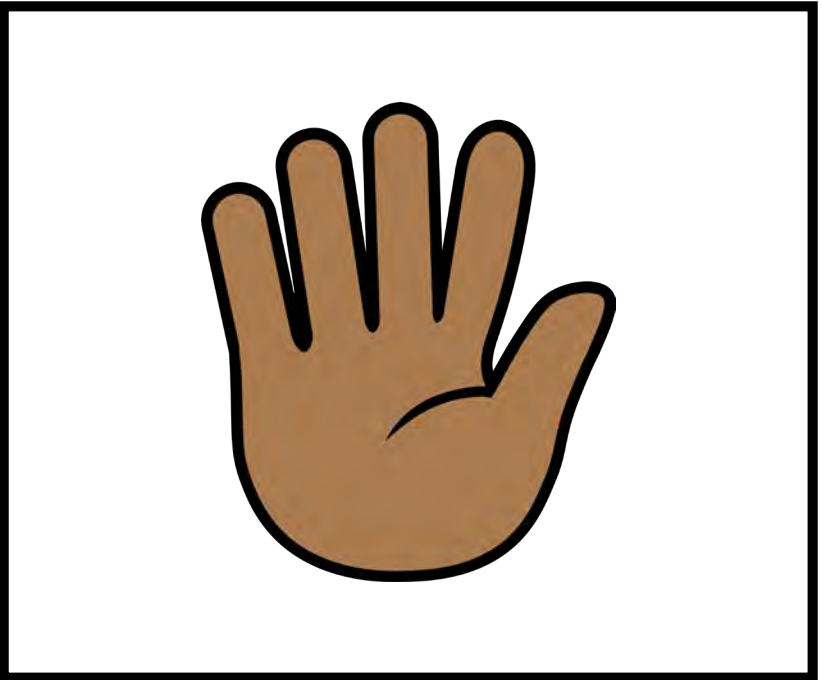
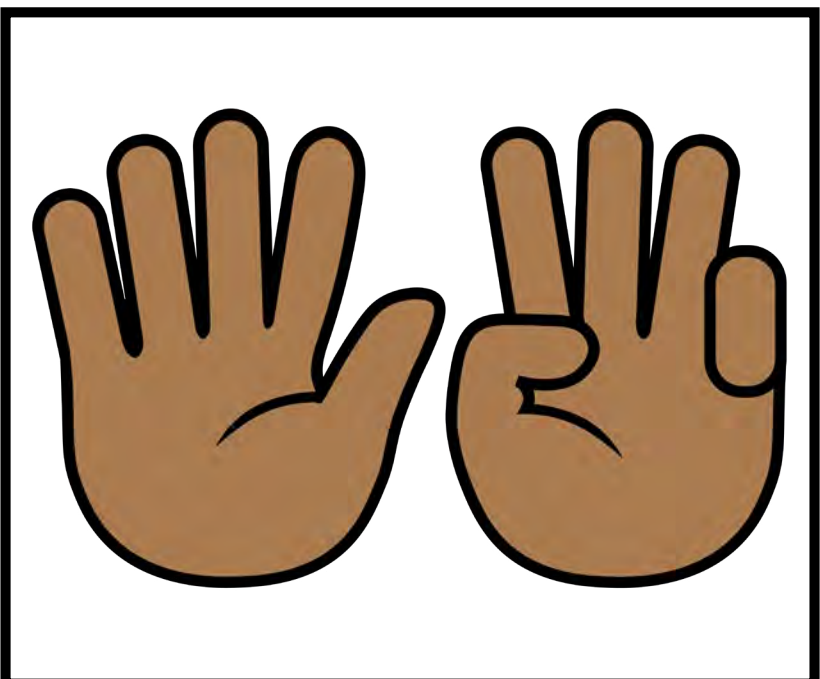
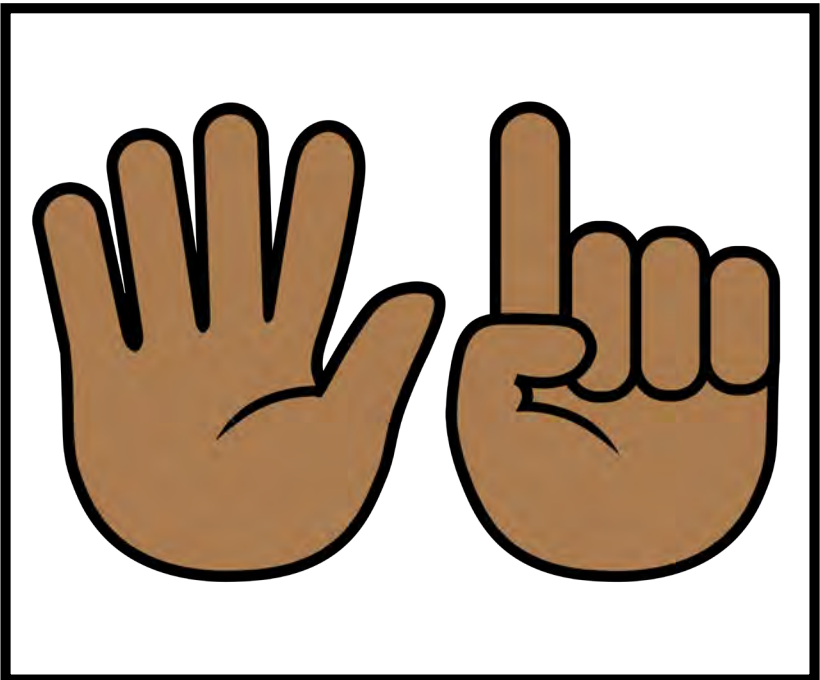

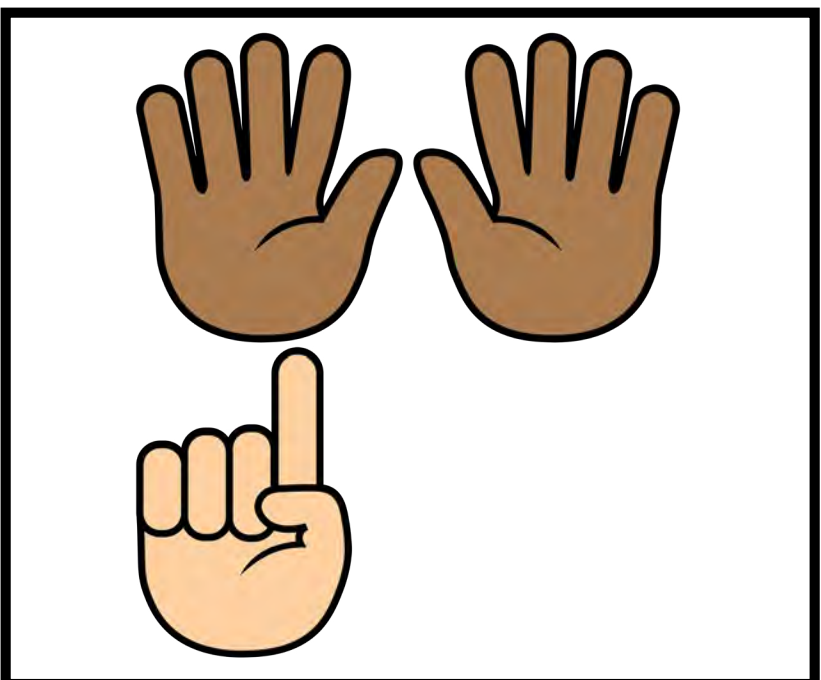
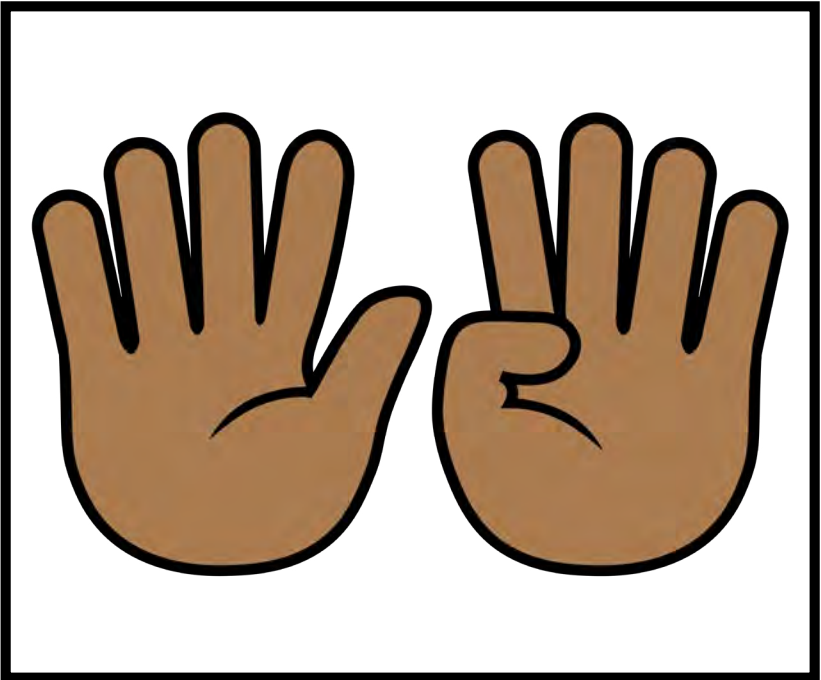
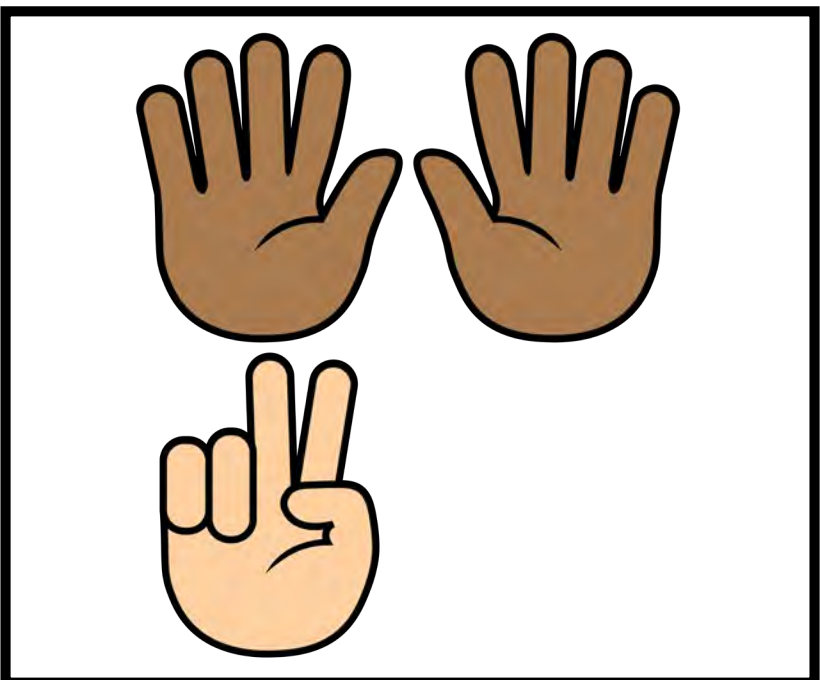
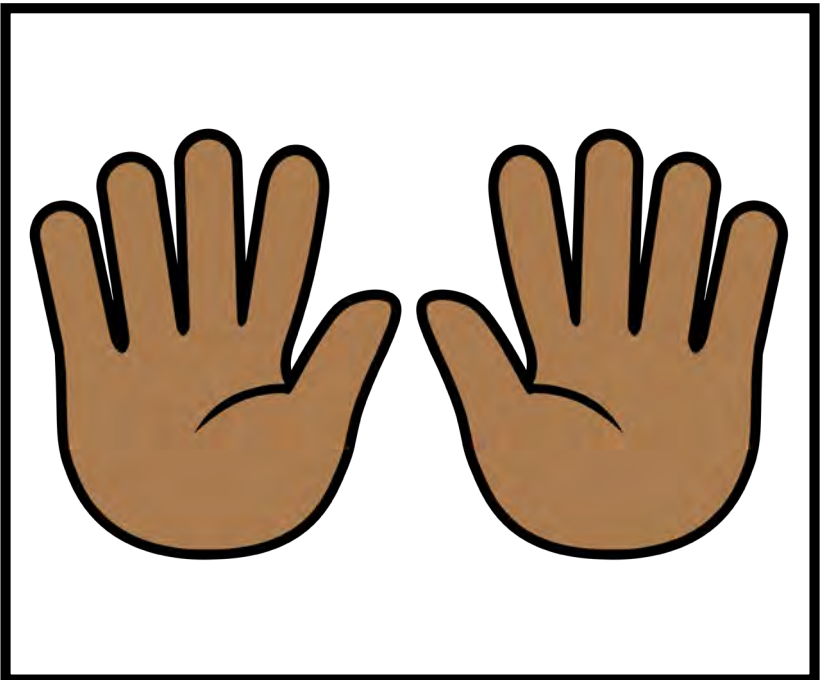

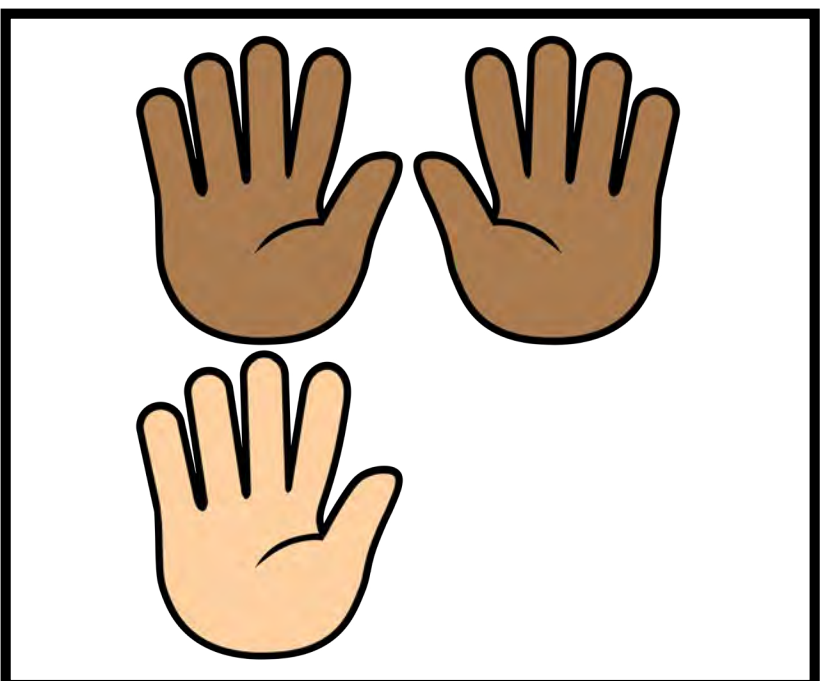
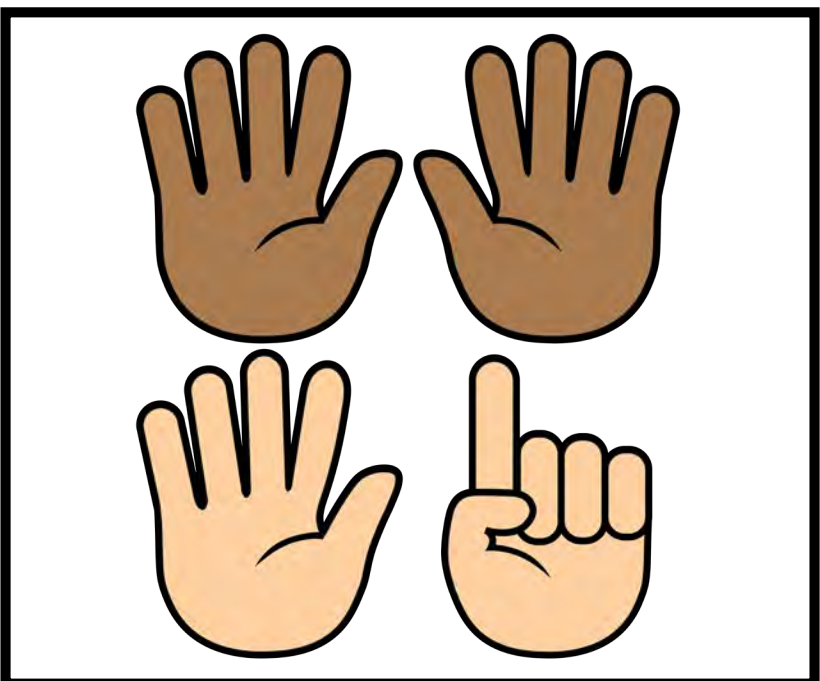
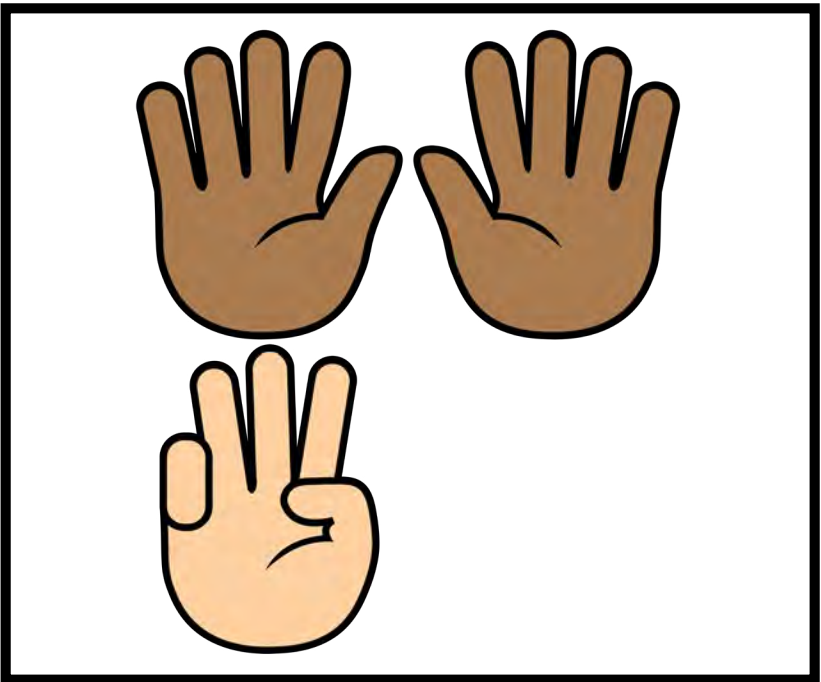
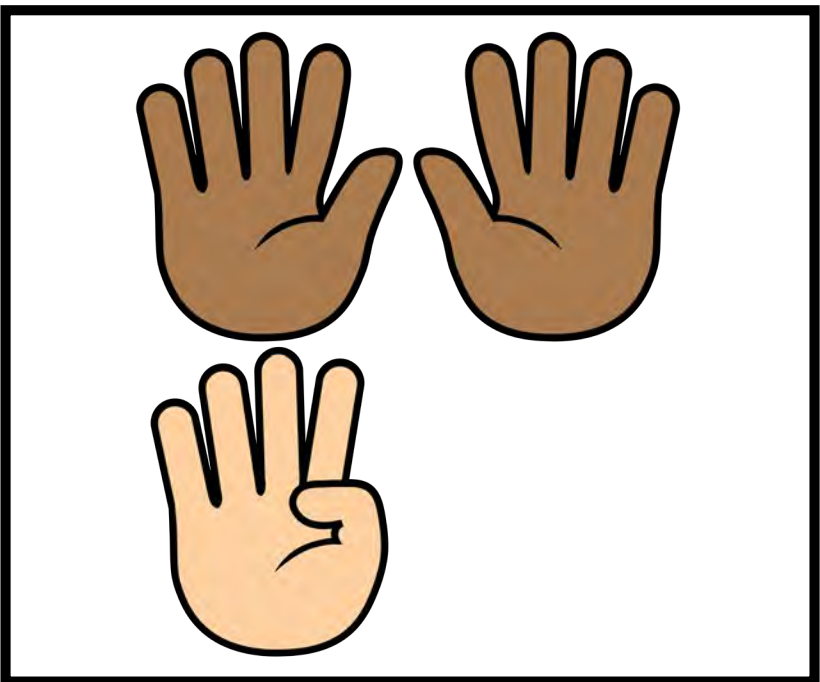

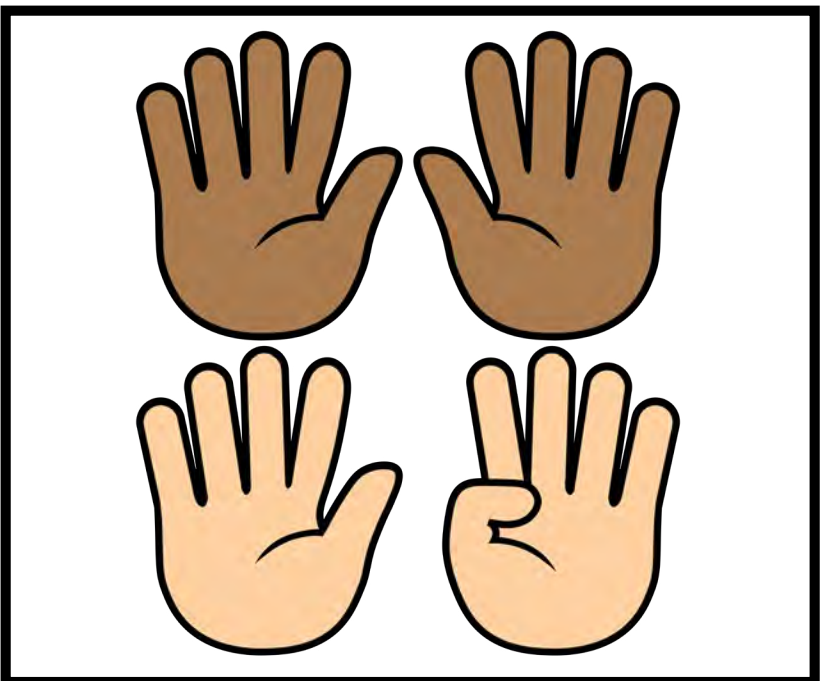
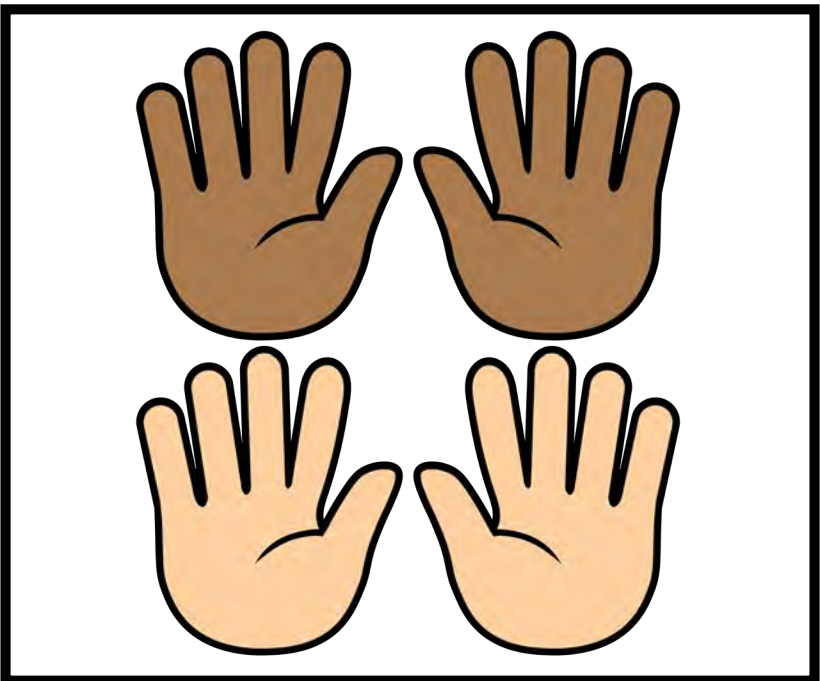
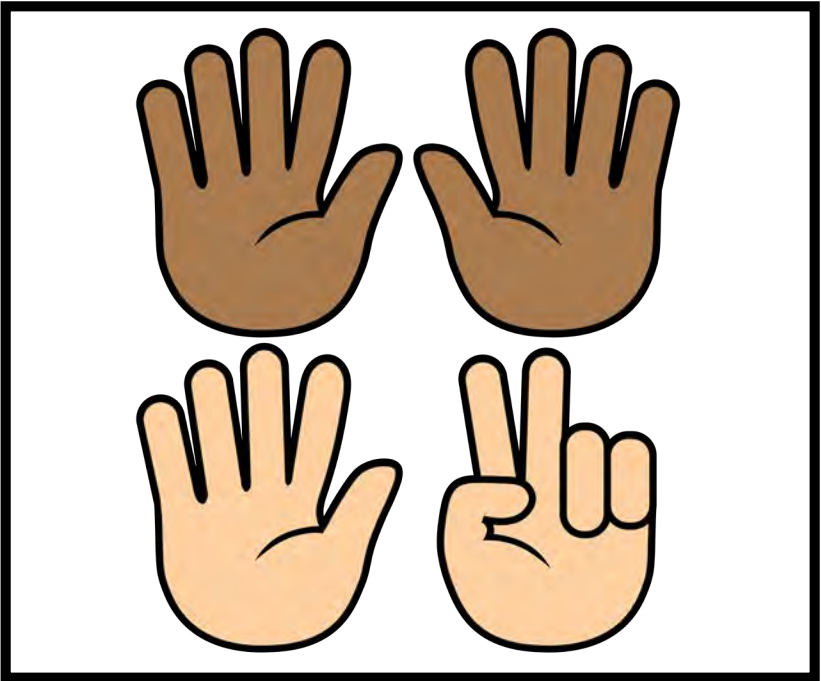
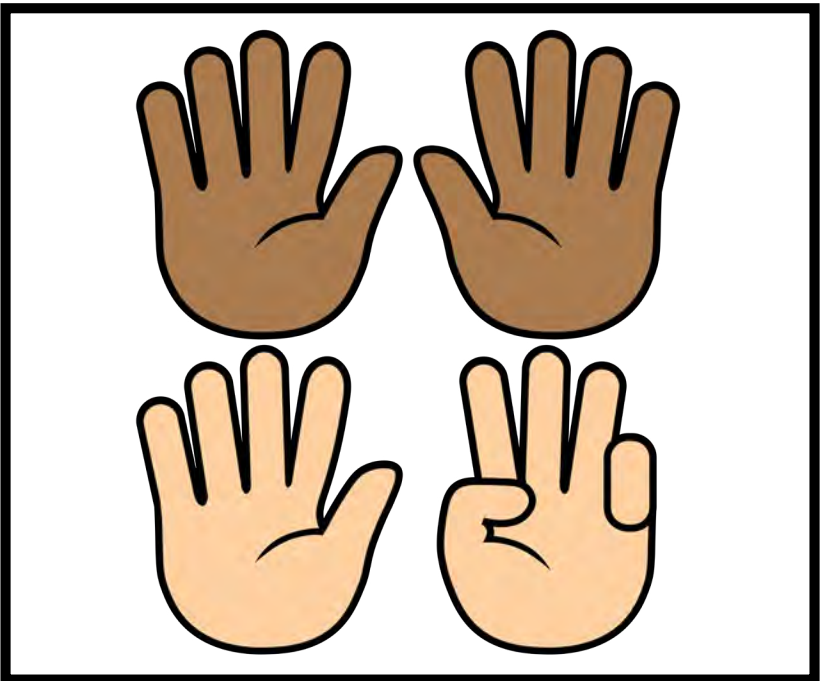

















1	   
---	--





0	   
---	---

3	   
---	---





2	   
---	---







5







4



7



6



9

Two pairs of hands illustrating the number 9. The top pair consists of two brown hands, each with 5 fingers on the left and 4 fingers on the right. The bottom pair consists of two peach hands, each with 5 fingers on the left and 4 fingers on the right.

8

Two pairs of hands illustrating the number 8. The top pair consists of two brown hands, each with 5 fingers on the left and 3 fingers on the right. The bottom pair consists of two peach hands, each with 5 fingers on the left and 3 fingers on the right.

11

Two pairs of hands illustrating the number 11. The top pair consists of two brown hands, each with 5 fingers on the left and 5 fingers on the right. The bottom pair consists of two peach hands, each with 5 fingers on the left and 1 finger on the right.

10

Two pairs of hands illustrating the number 10. The top pair consists of two brown hands, each with 5 fingers on the left and 5 fingers on the right. The bottom pair consists of two peach hands, each with 5 fingers on the left and 5 fingers on the right.

12

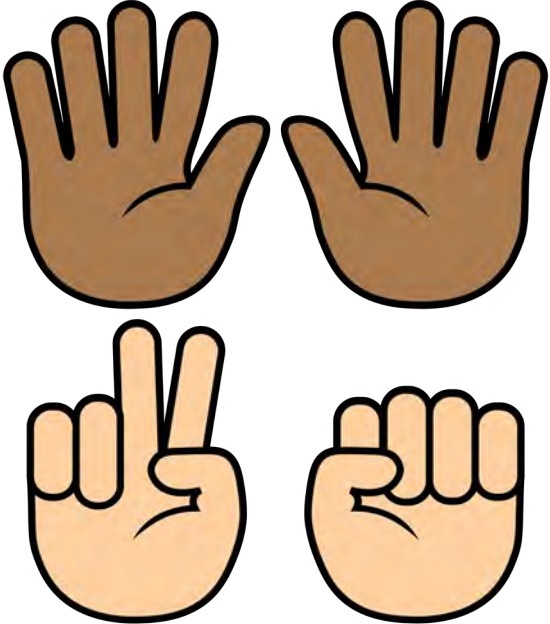

13

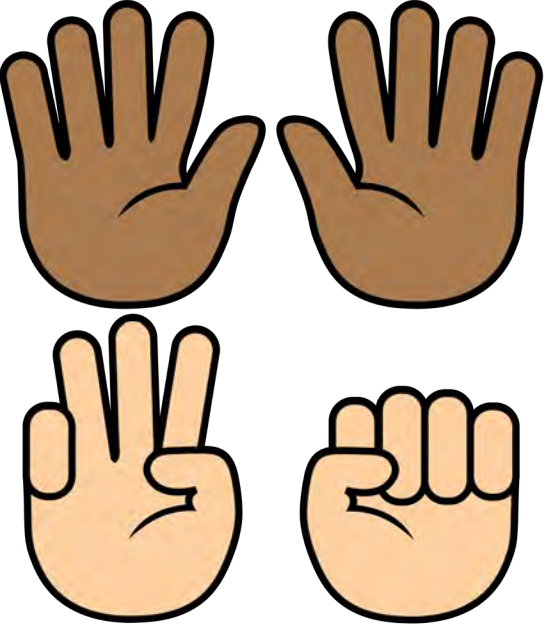

14

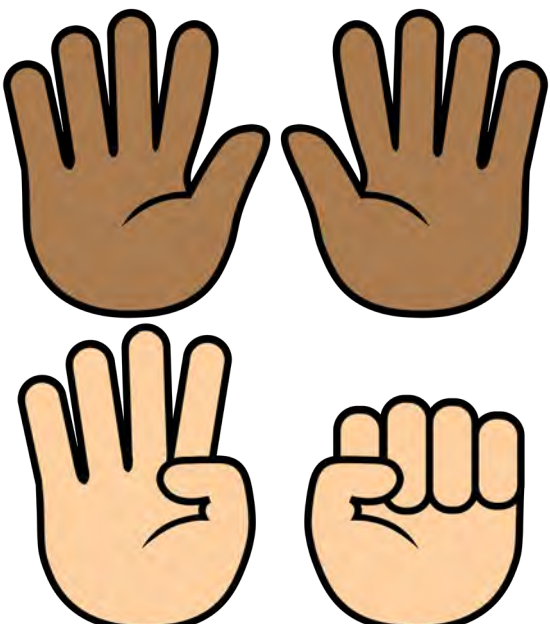

15

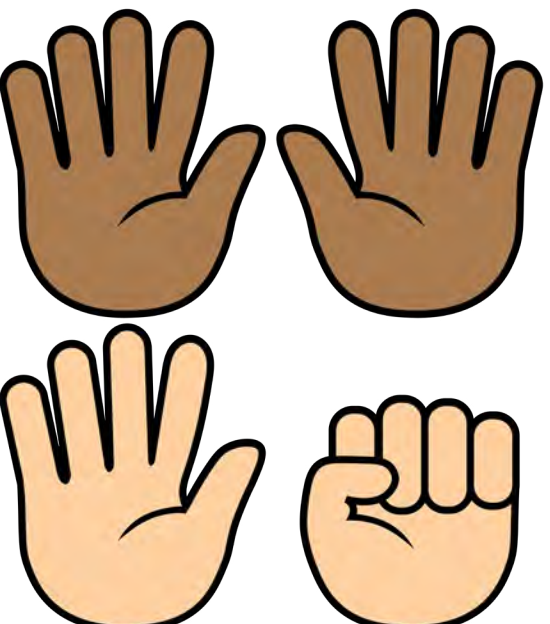

16

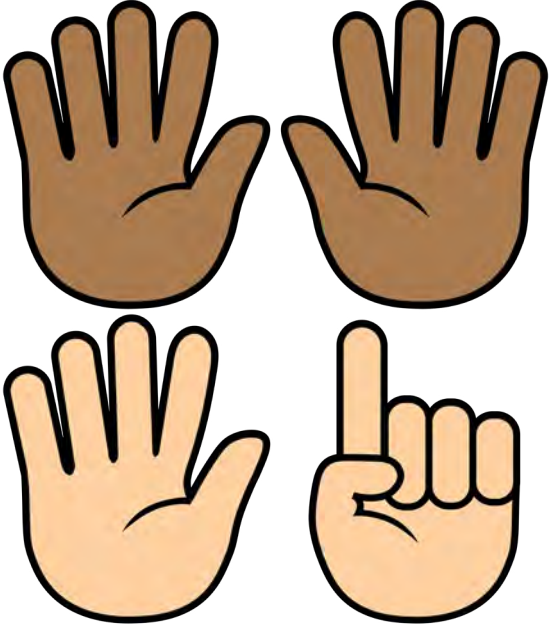

17

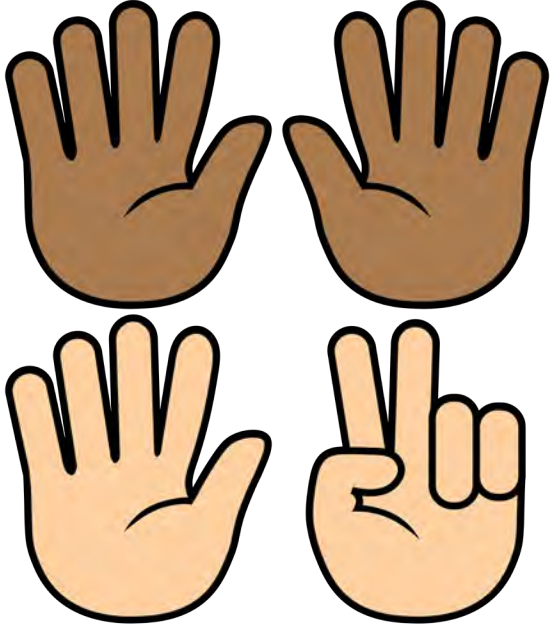

18

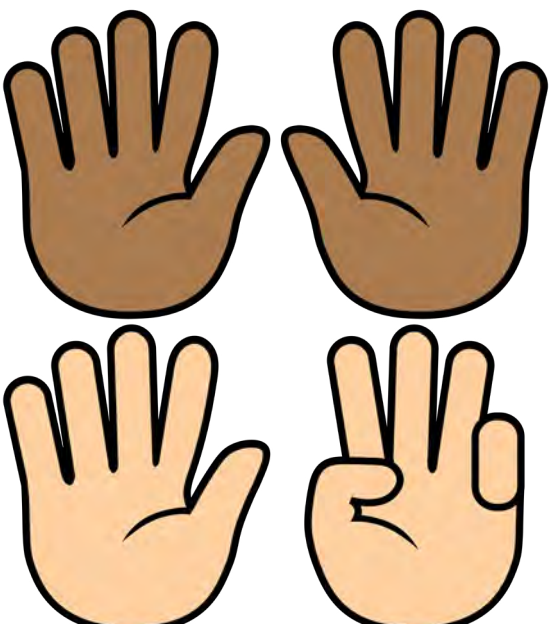

19

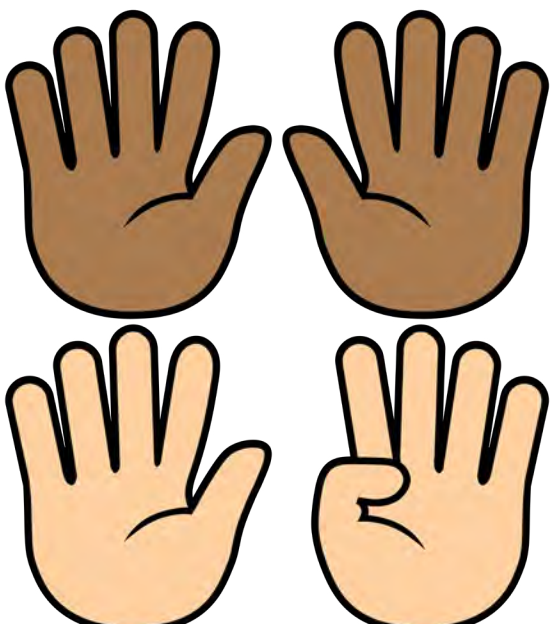

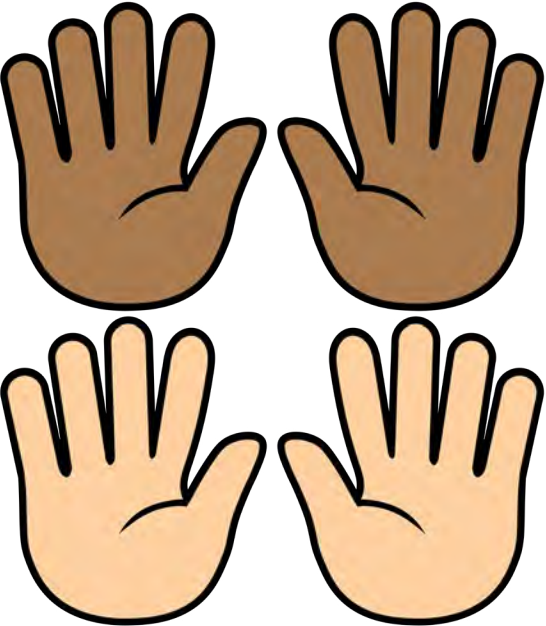

	<p data-bbox="157 342 361 488">20</p>
--	---------------------------------------



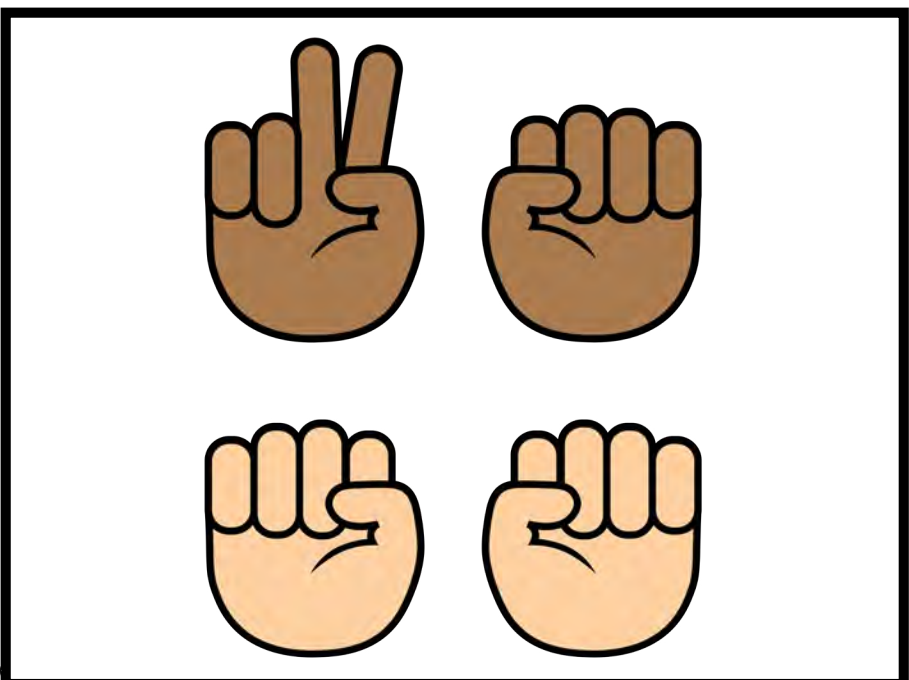
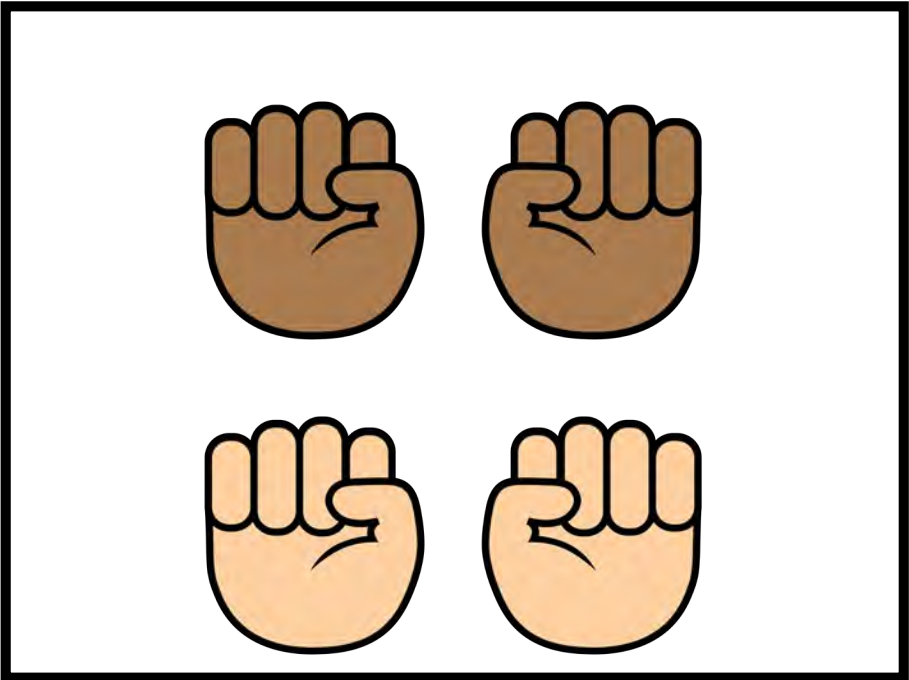
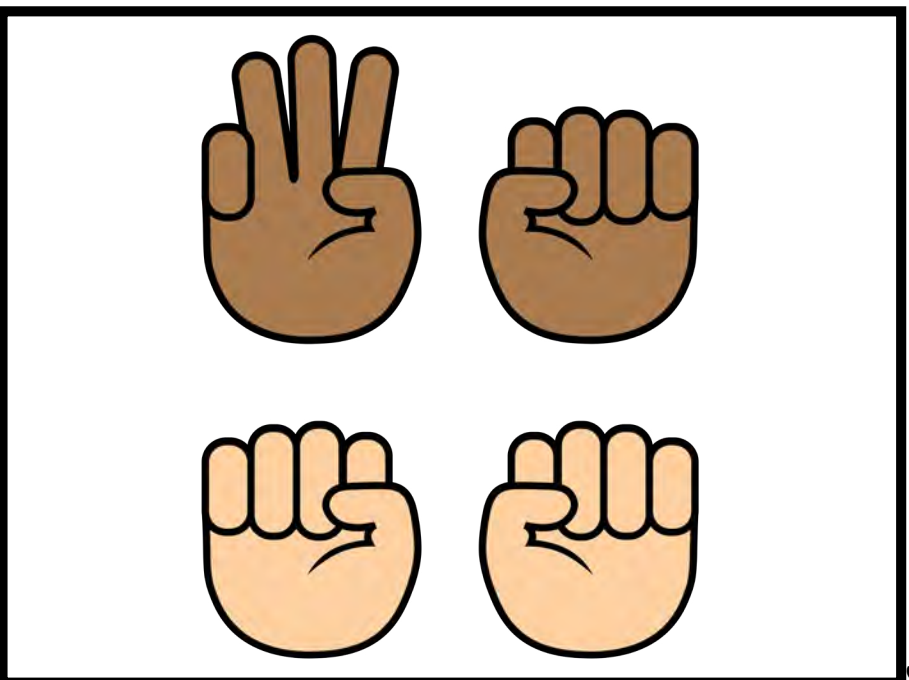
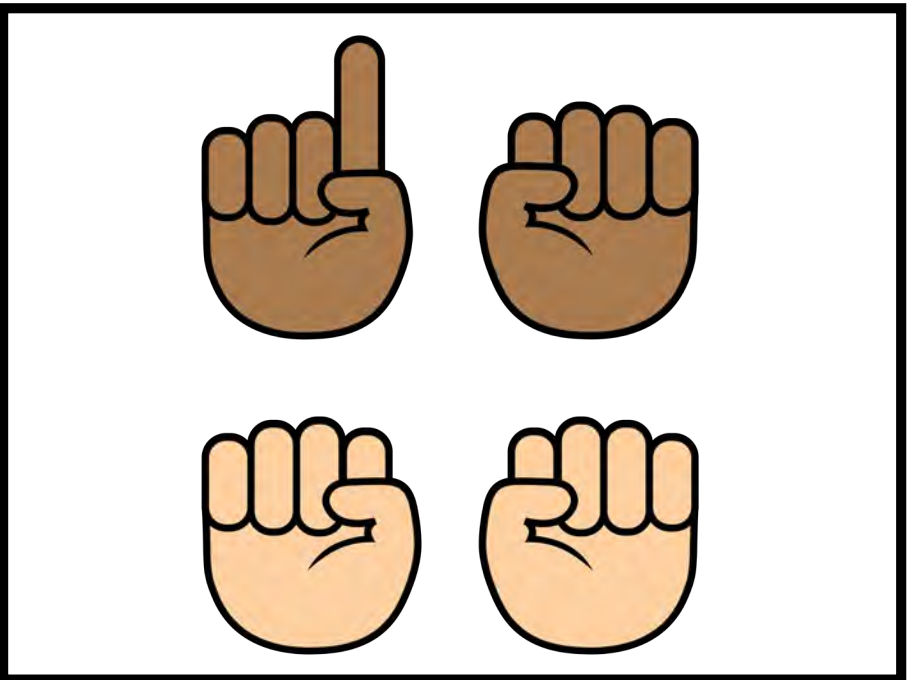

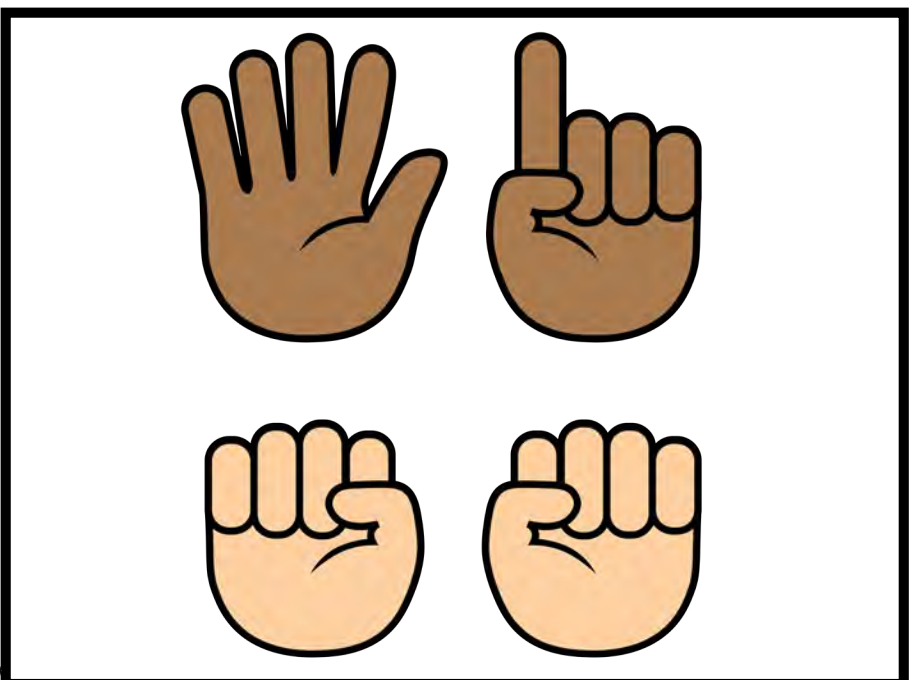
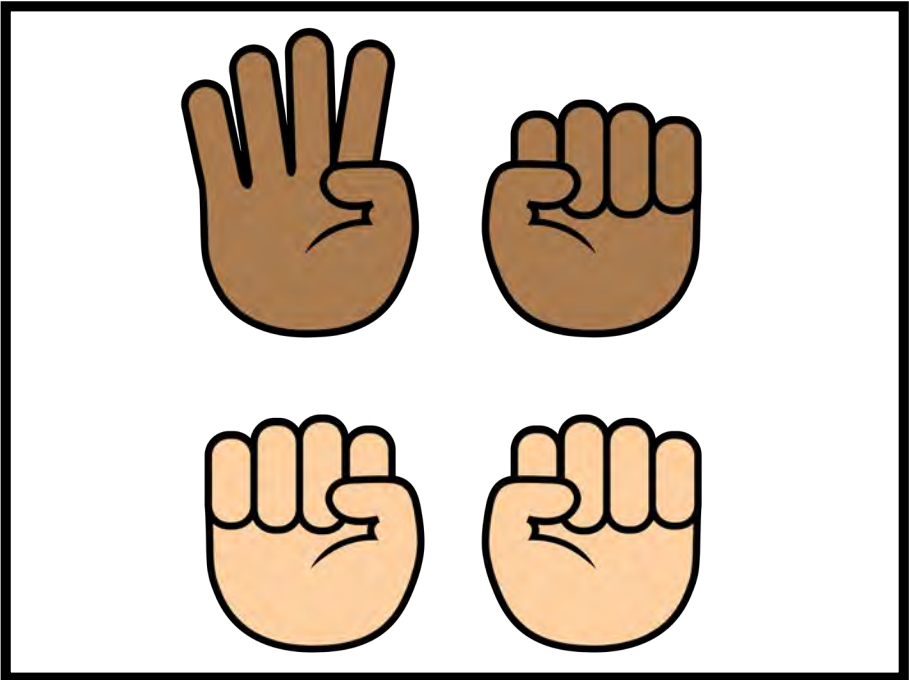
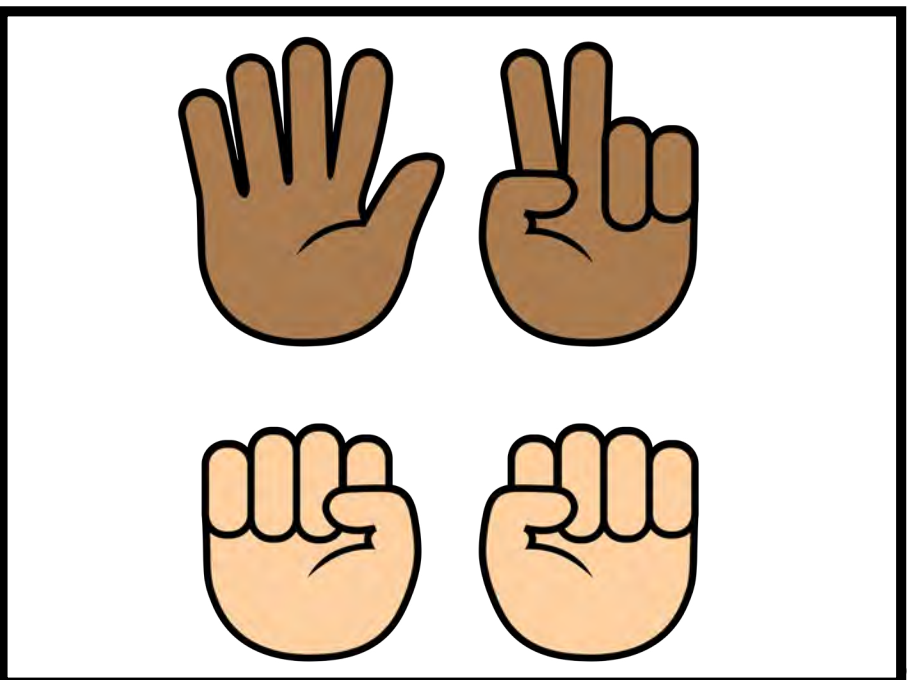
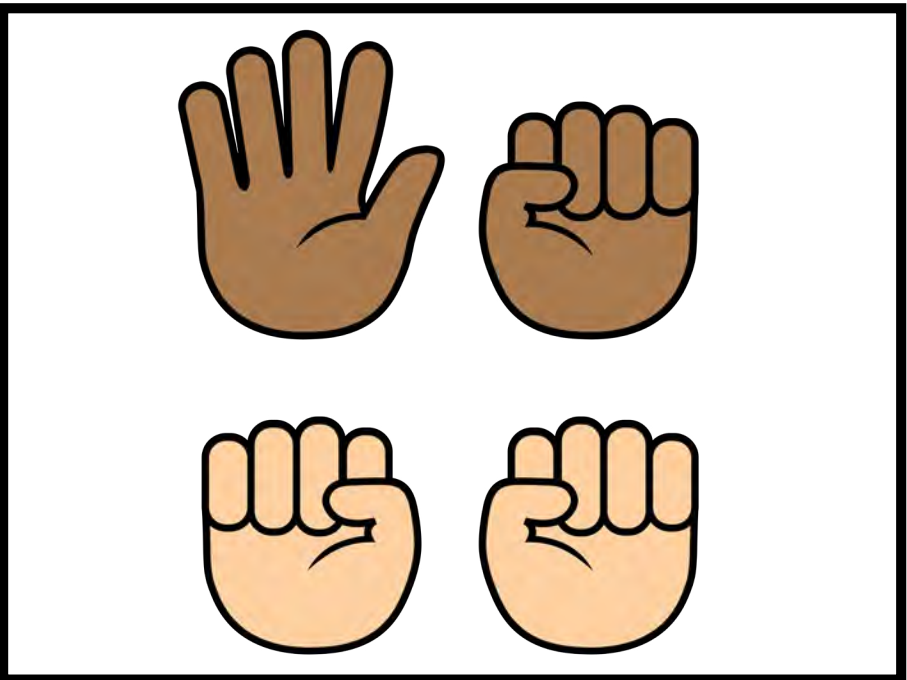

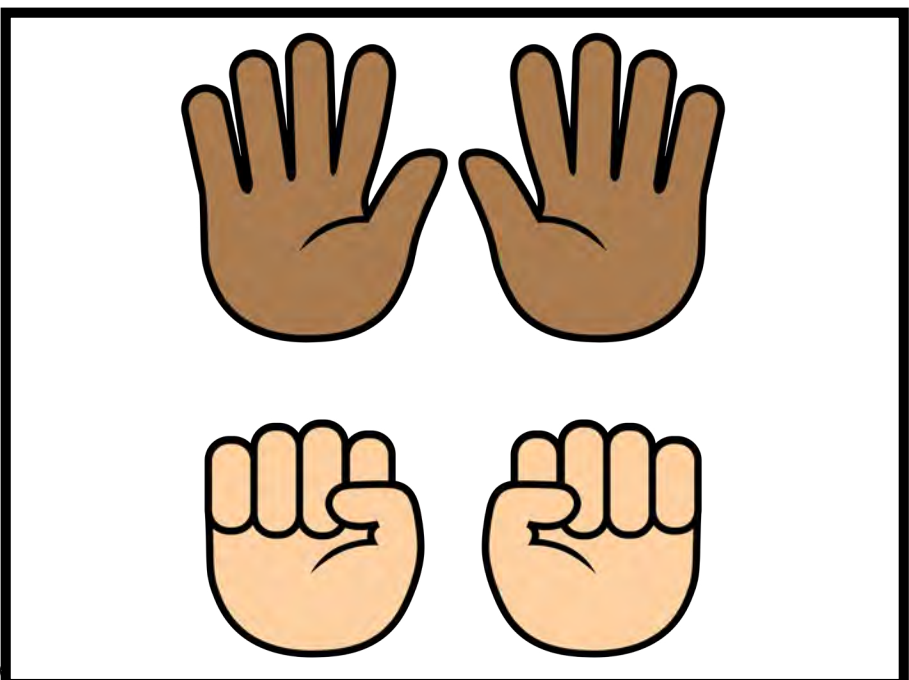
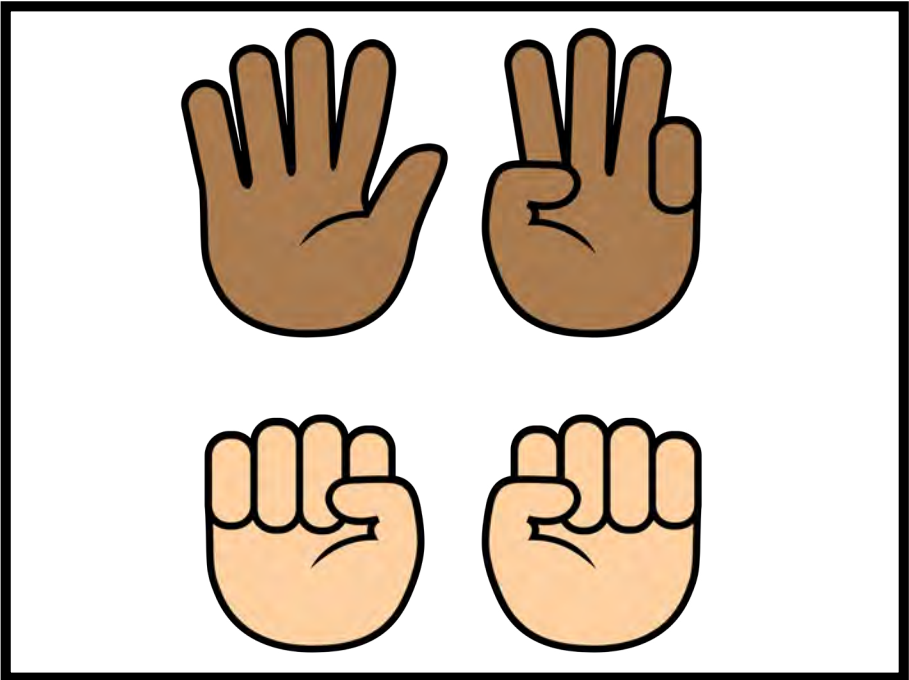
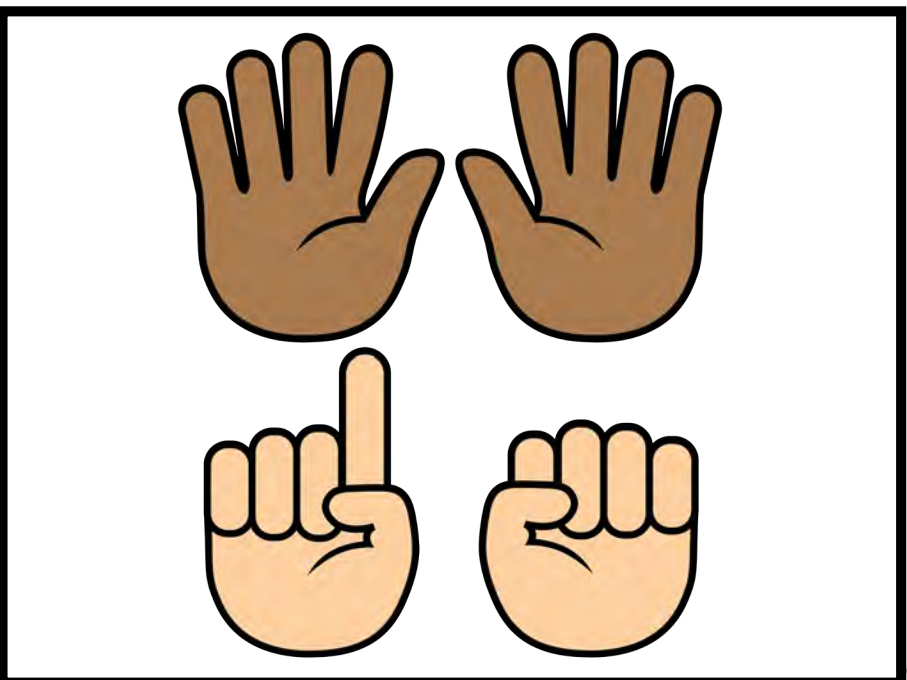
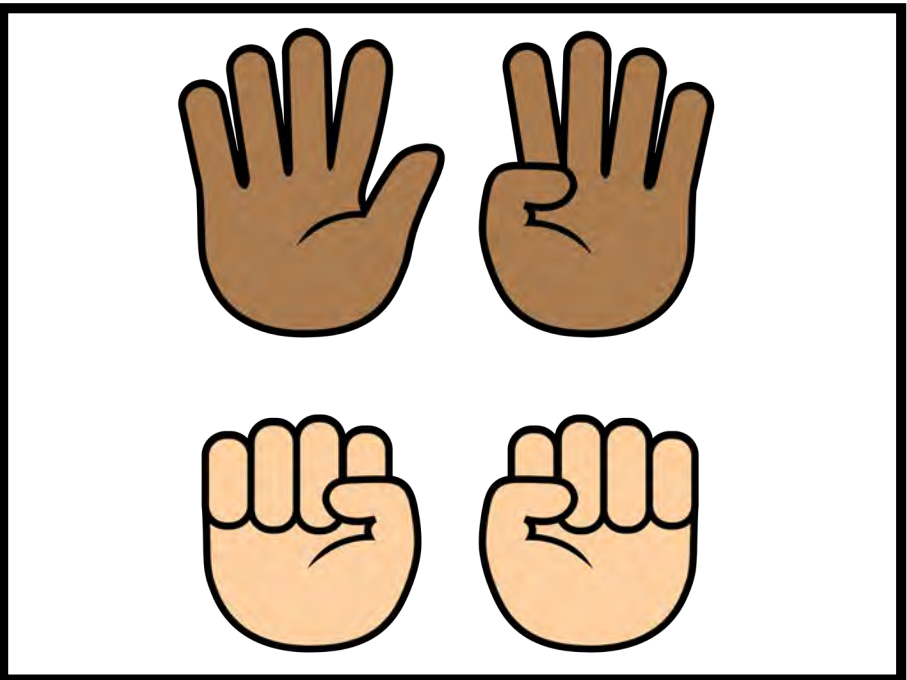

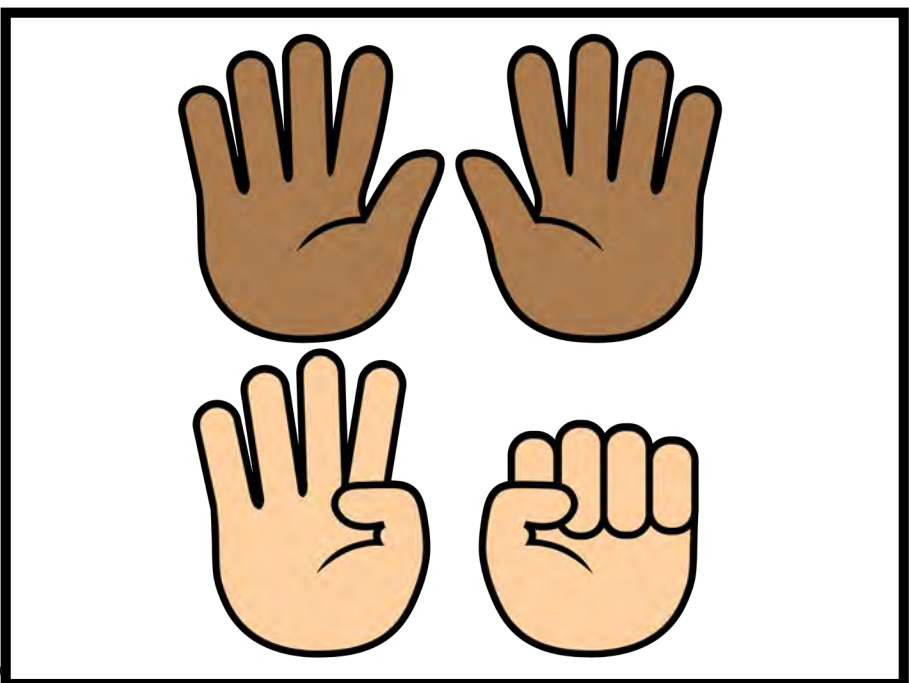
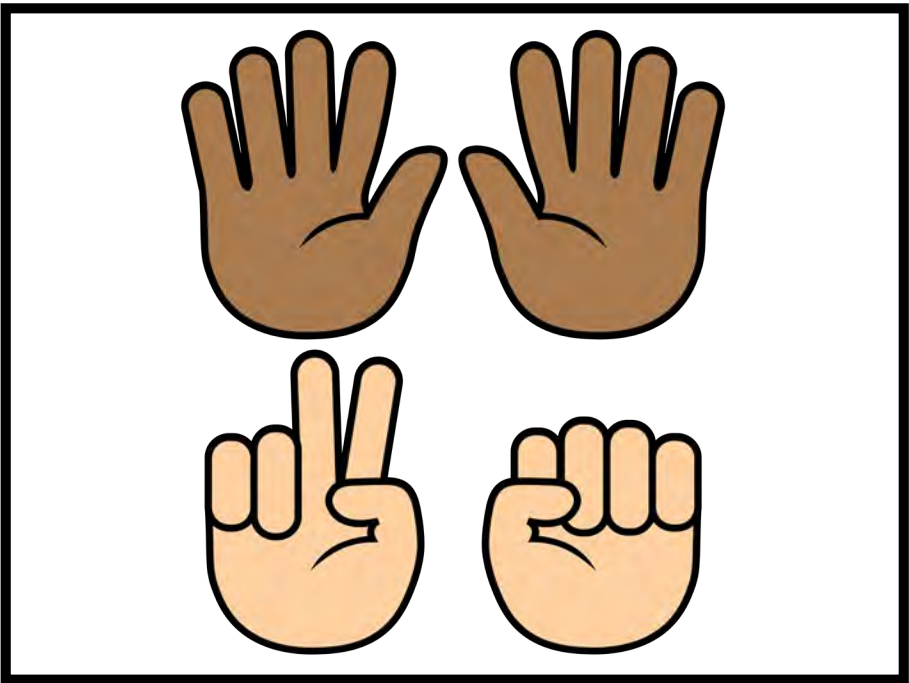
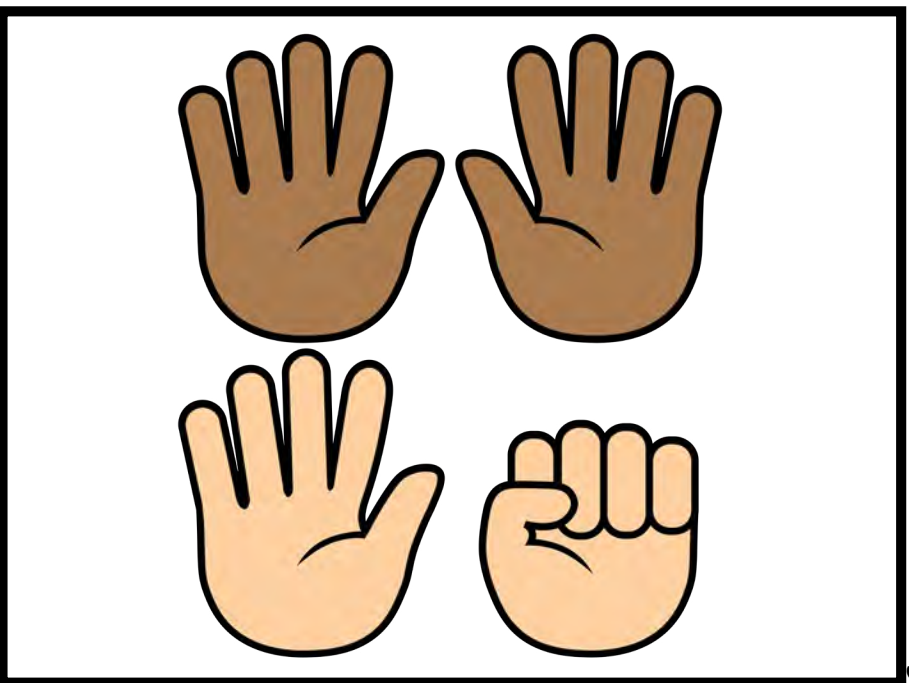
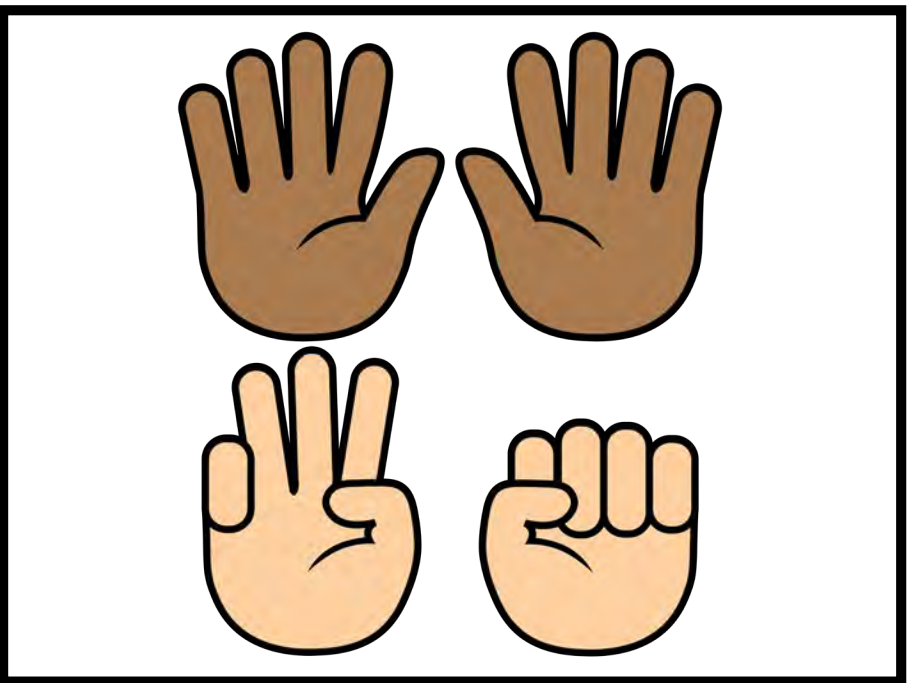

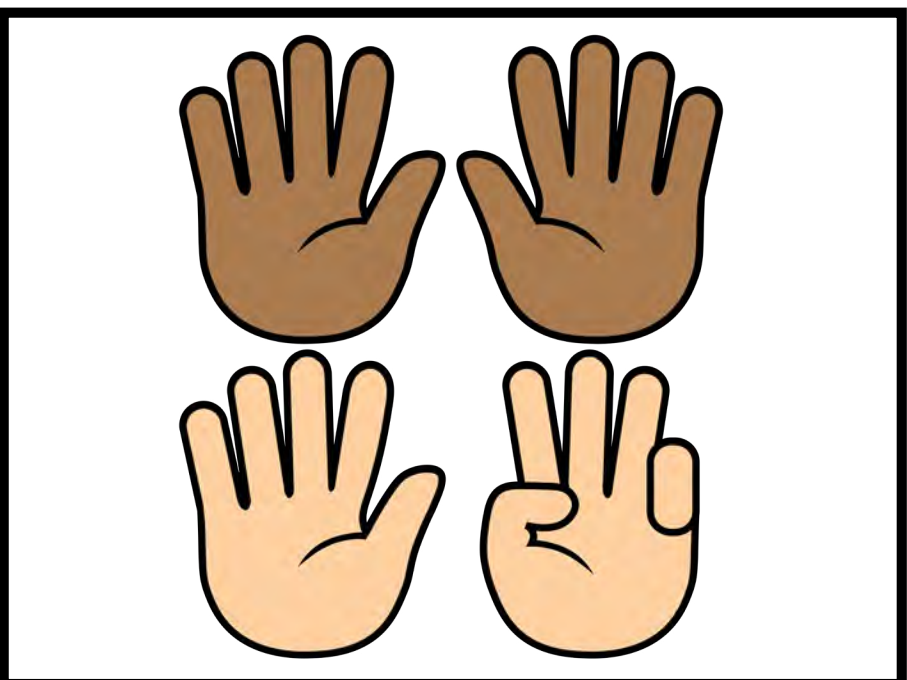
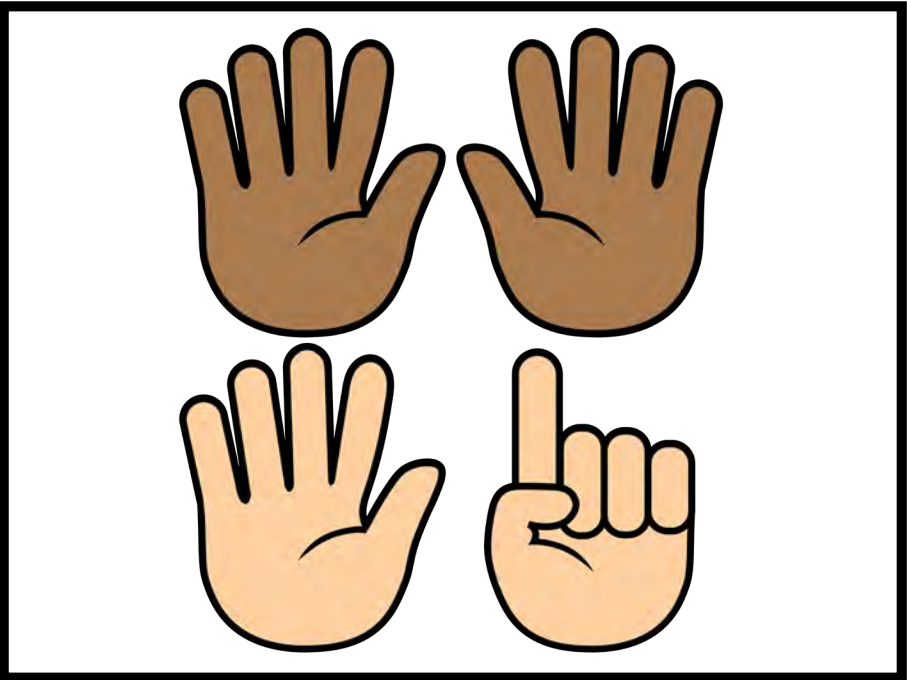
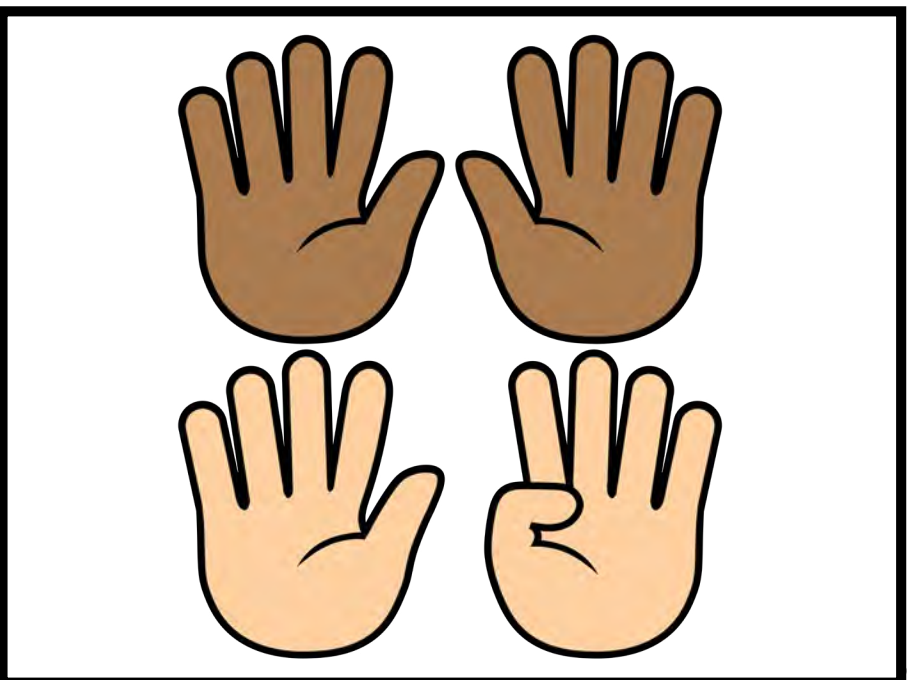
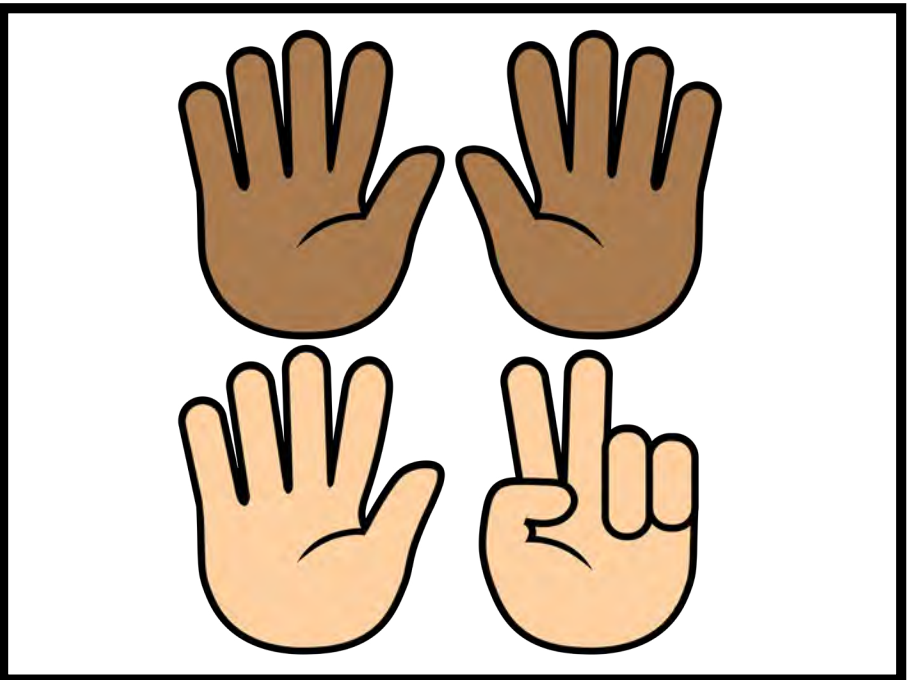

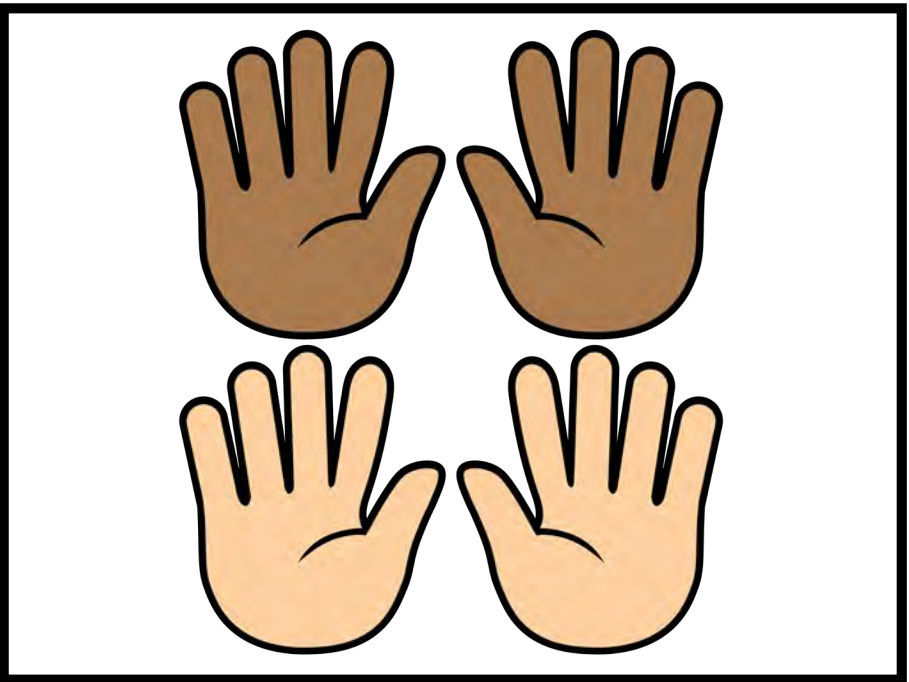



Dé

1. Coupez le long de lignes pleines.
2. Pliez sur les lignes pointillées.
3. Mettez de la colle sur les languettes et collées.

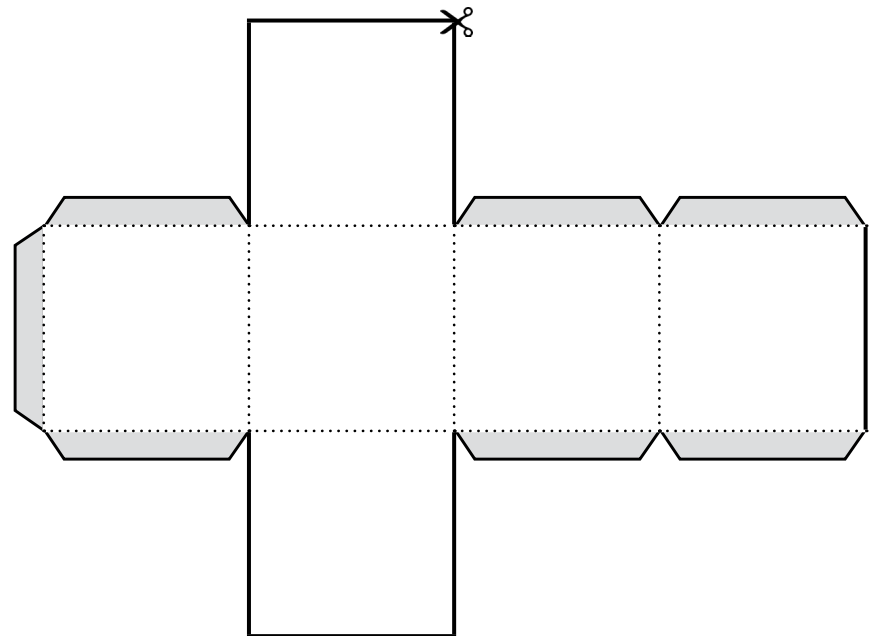
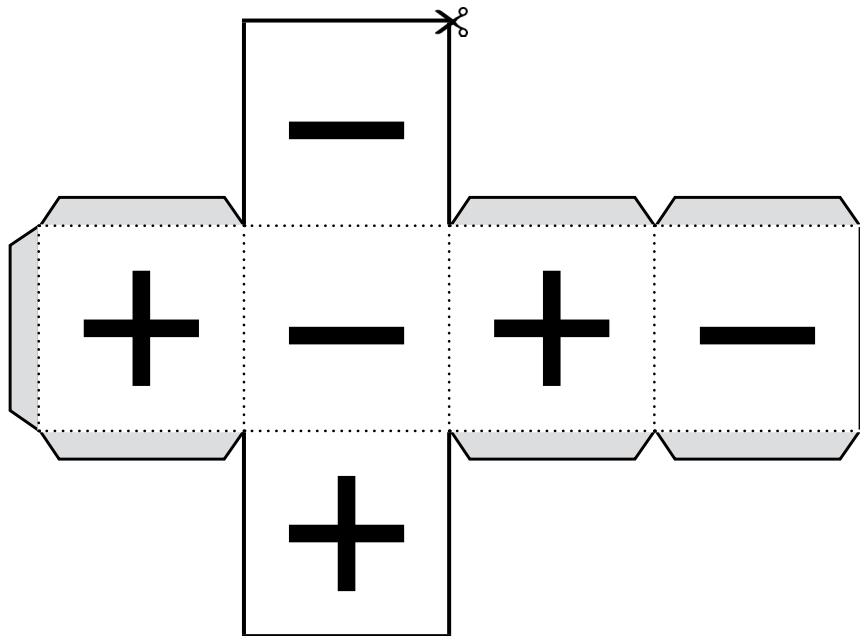
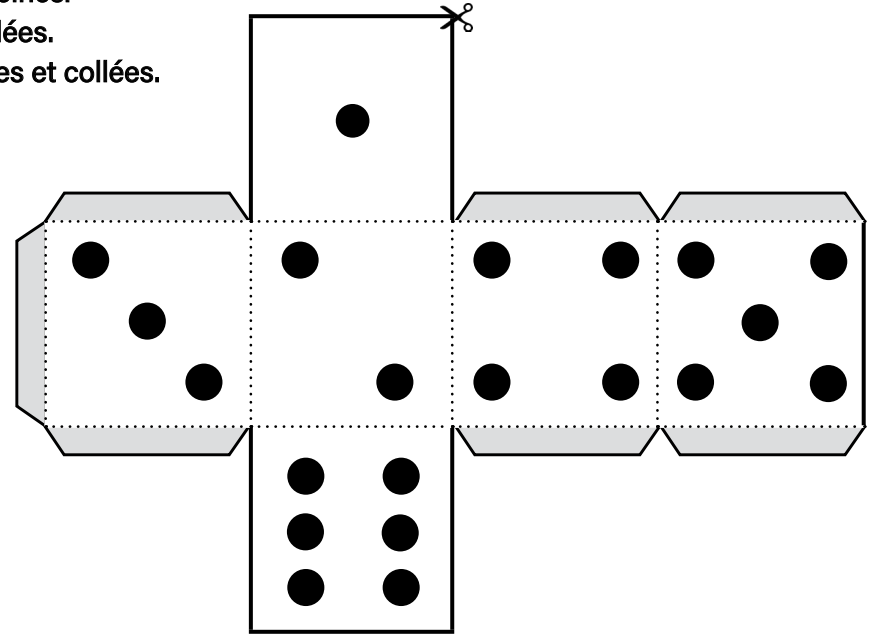
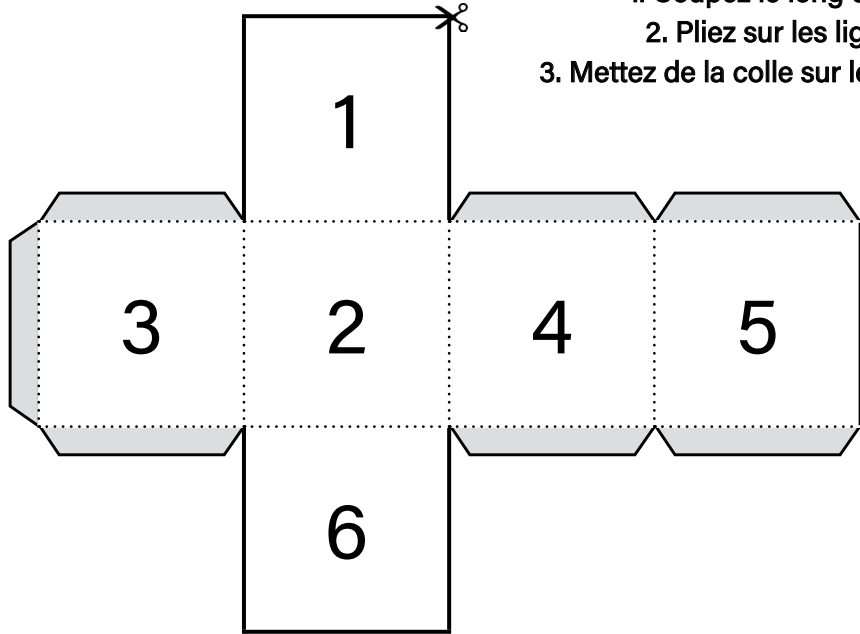

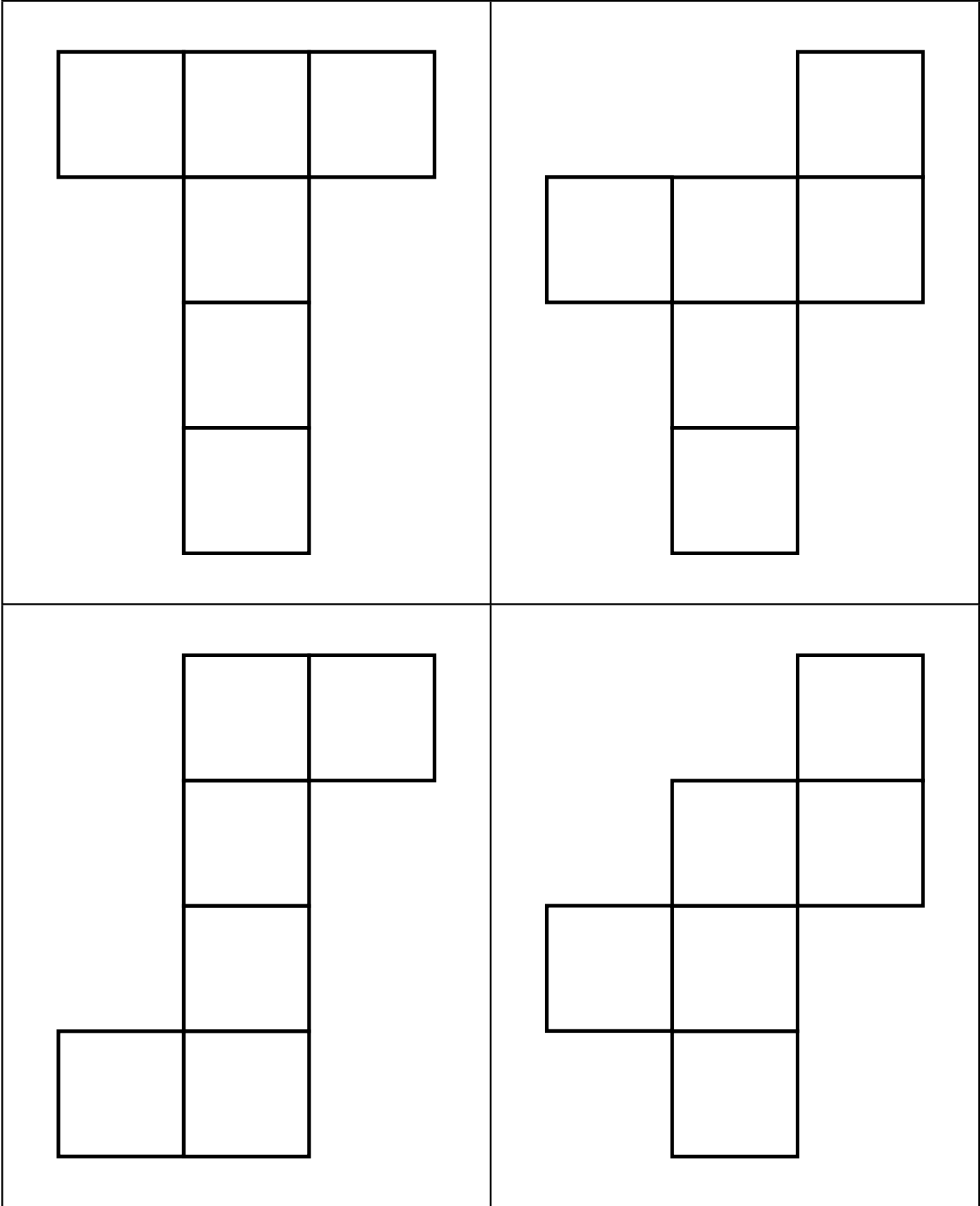

Cube

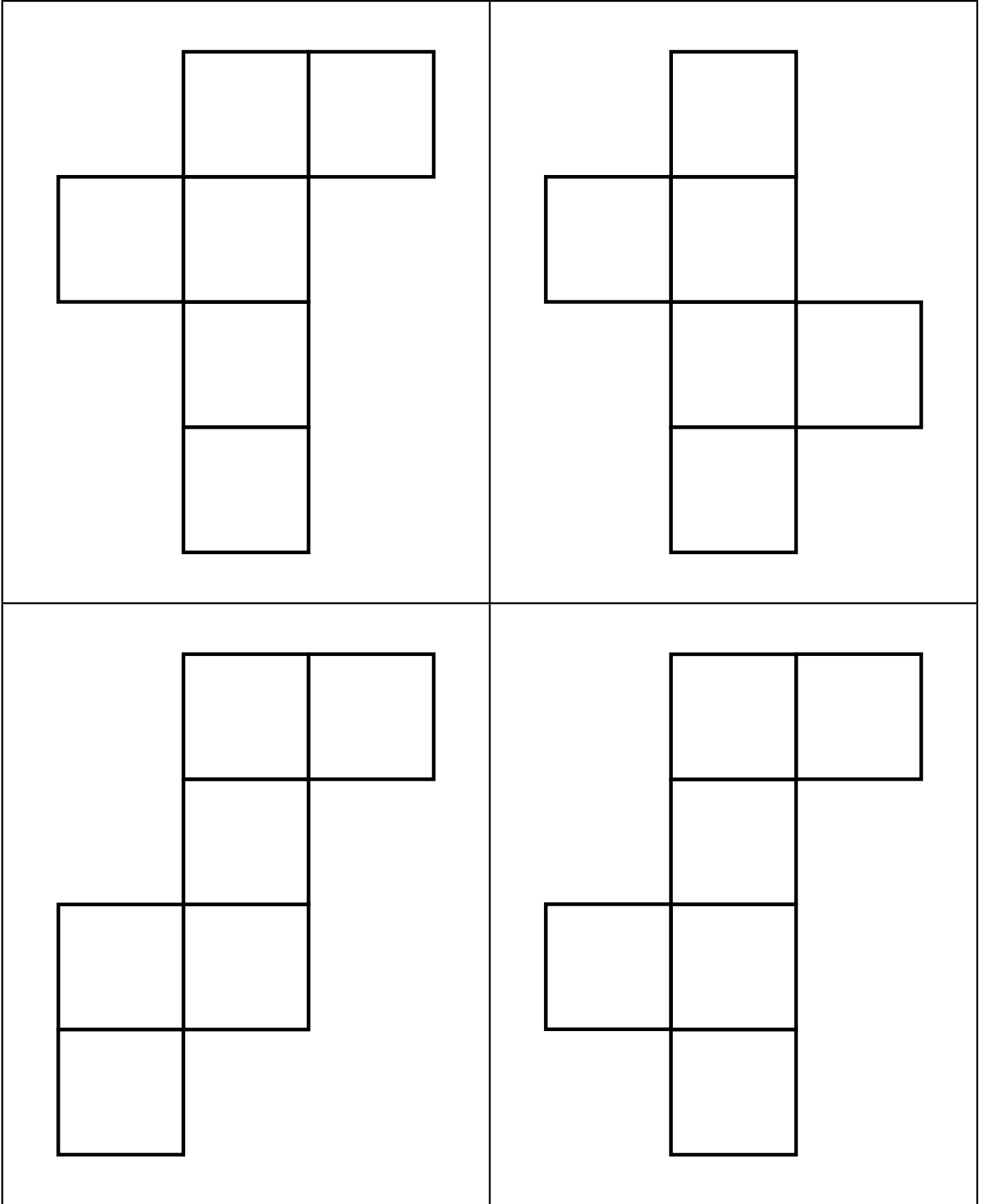

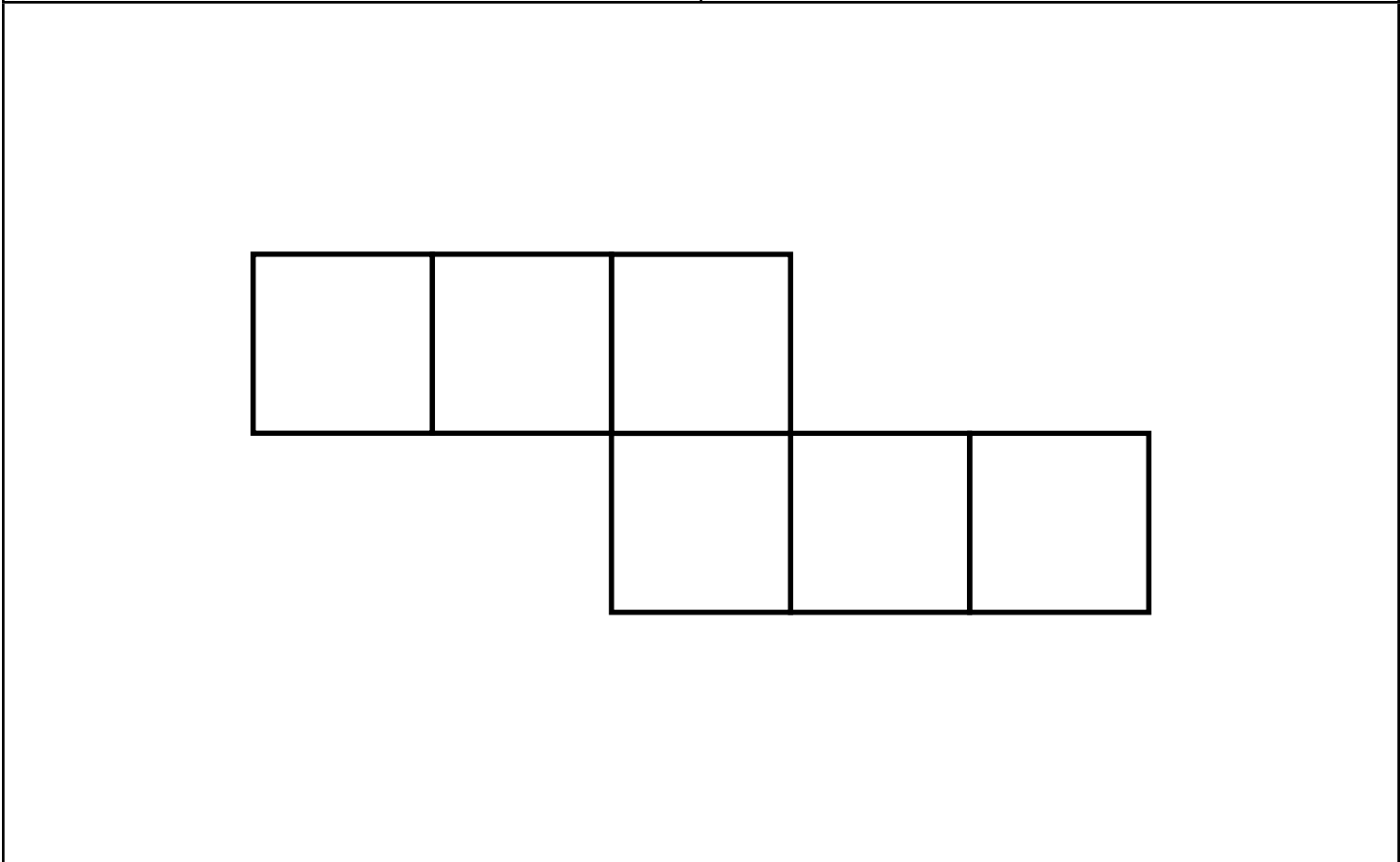
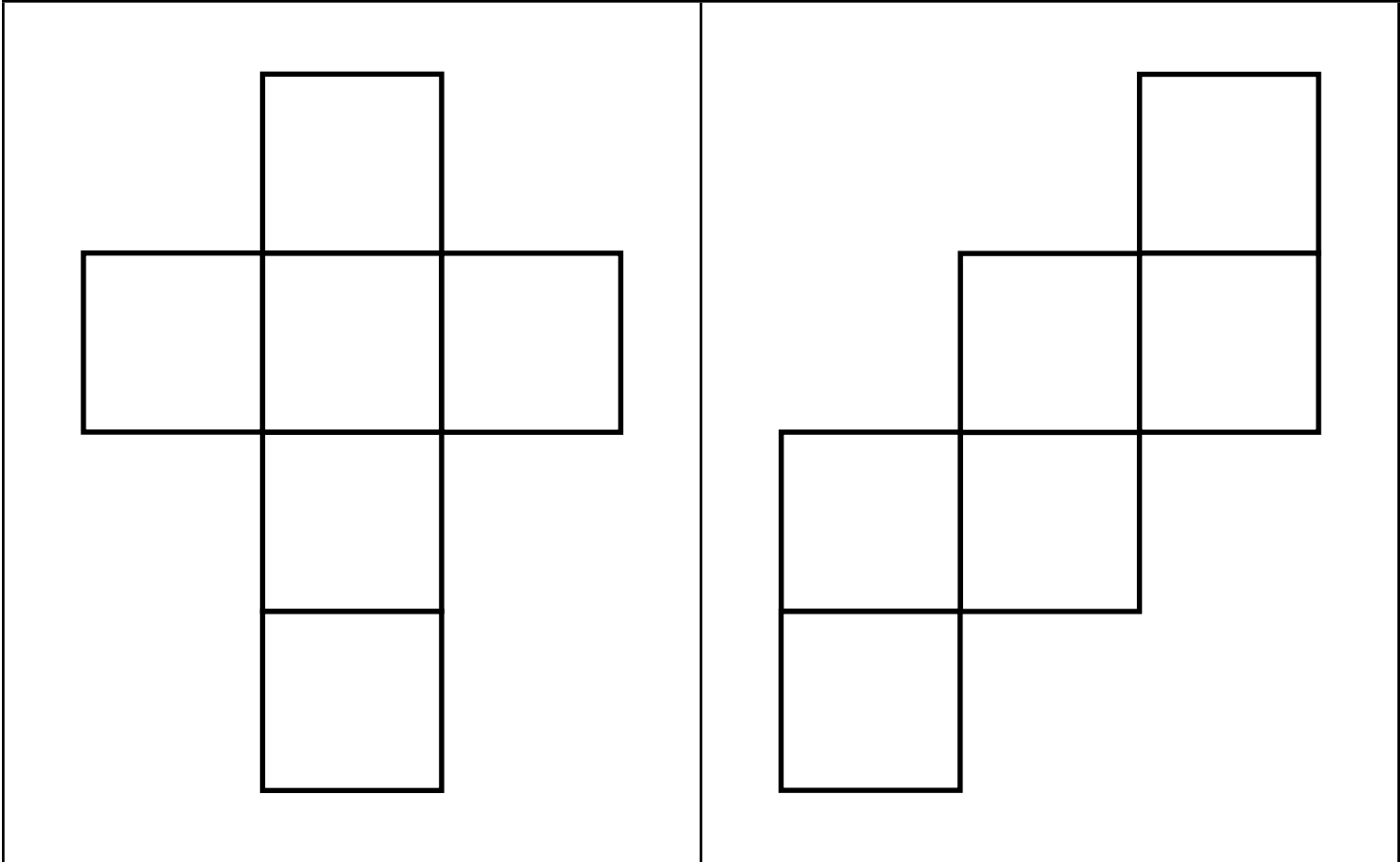

Cube

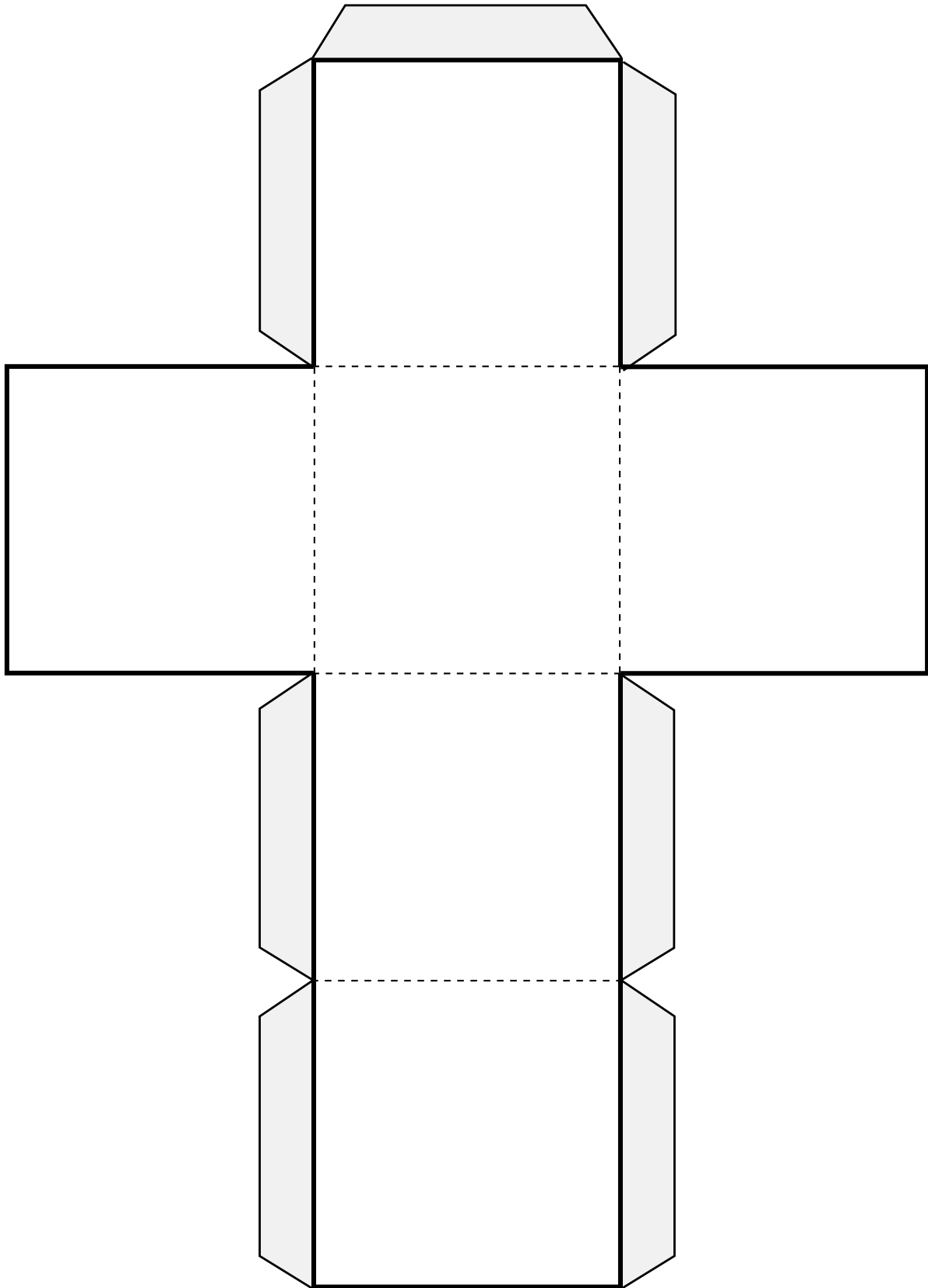

Prisme à base rectangulaire

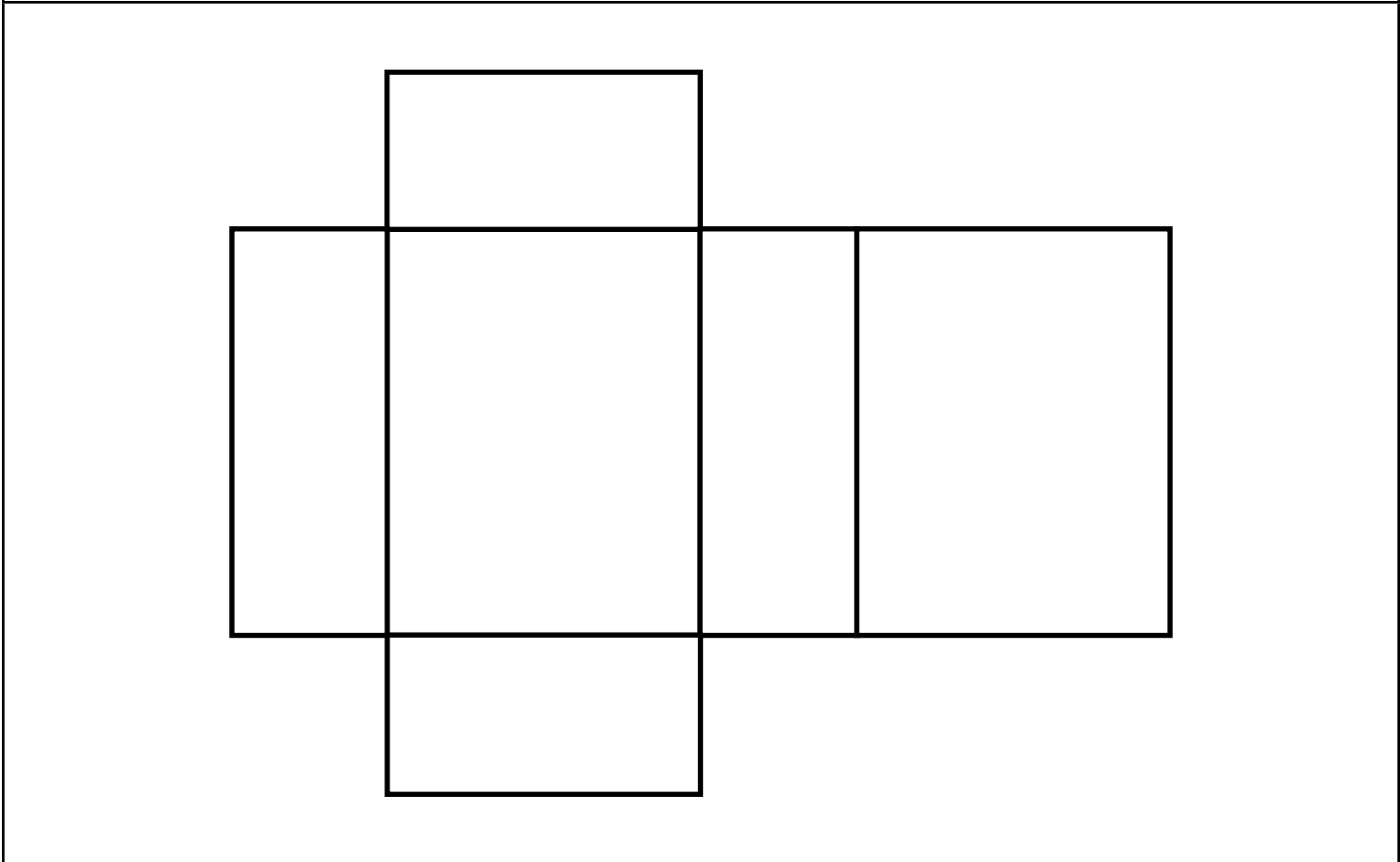
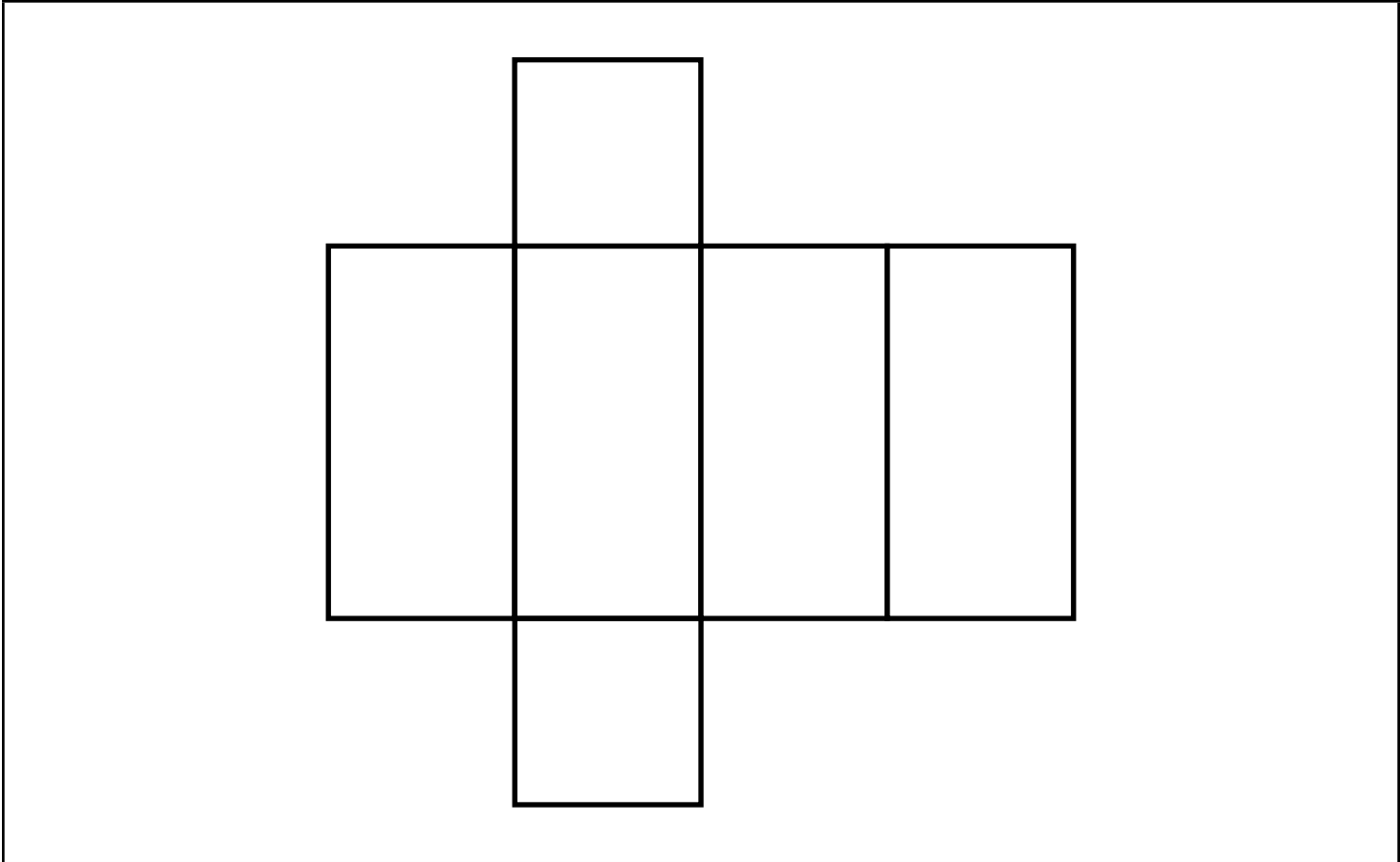

Prisme à base rectangulaire

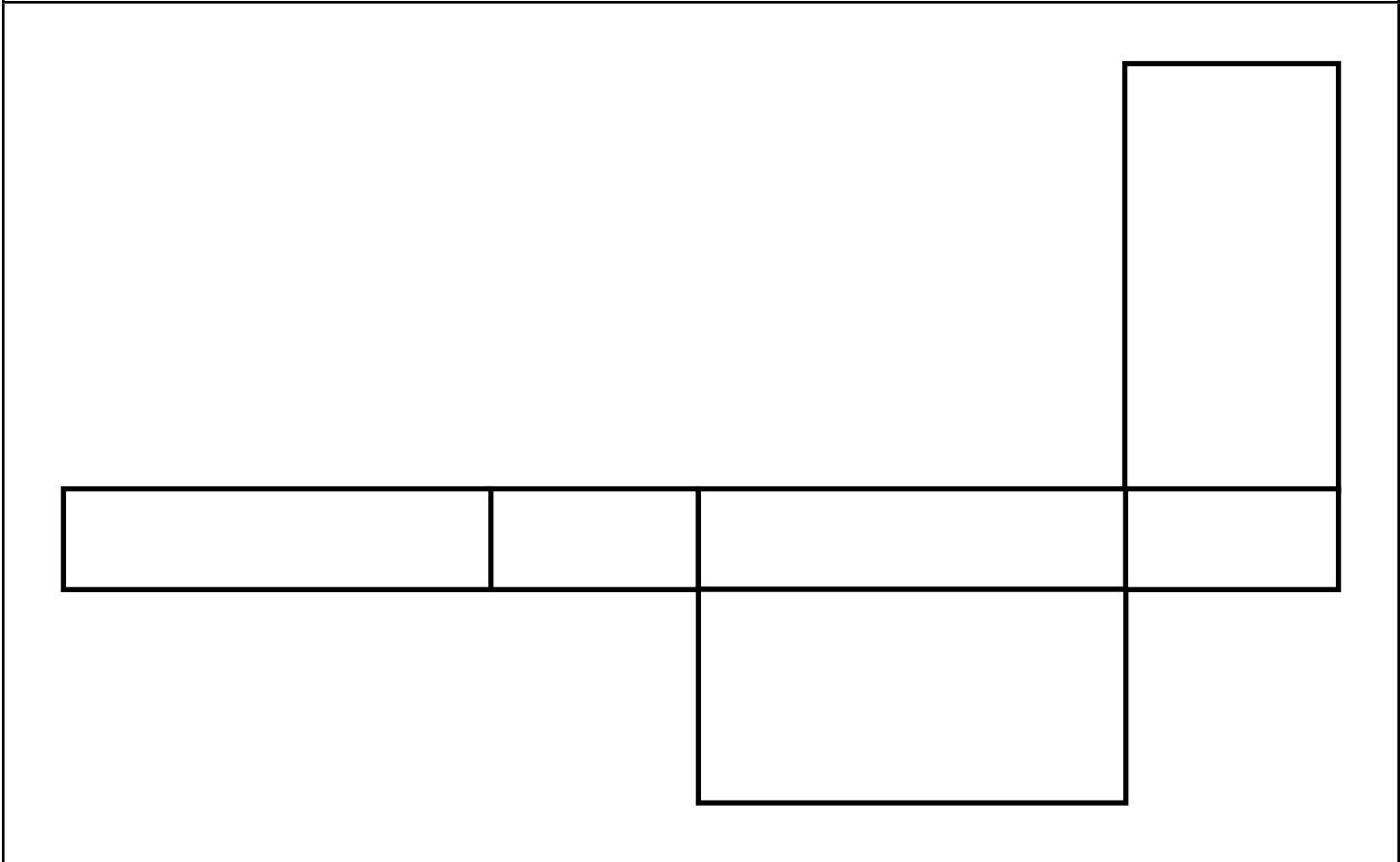
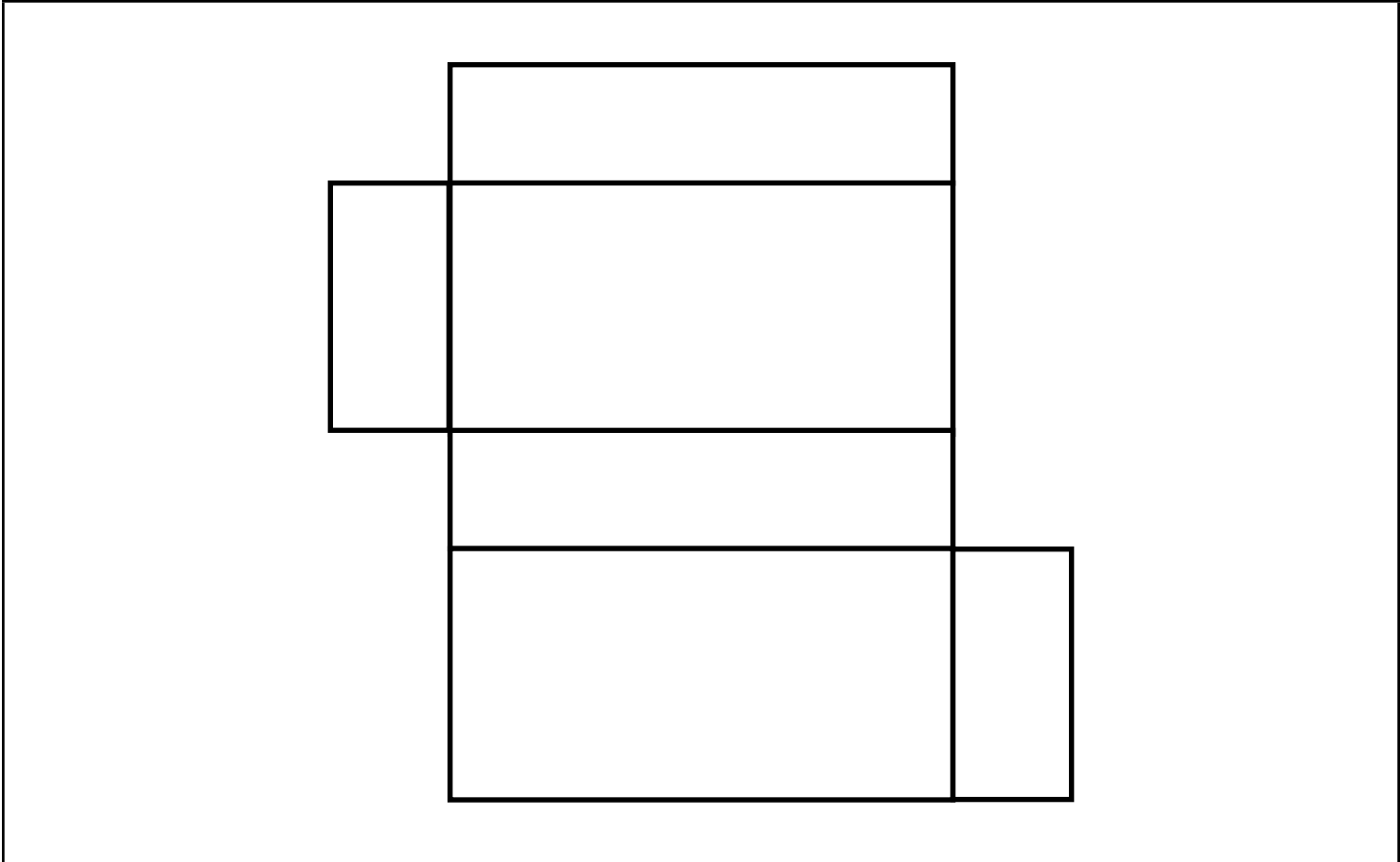

Prisme à base rectangulaire

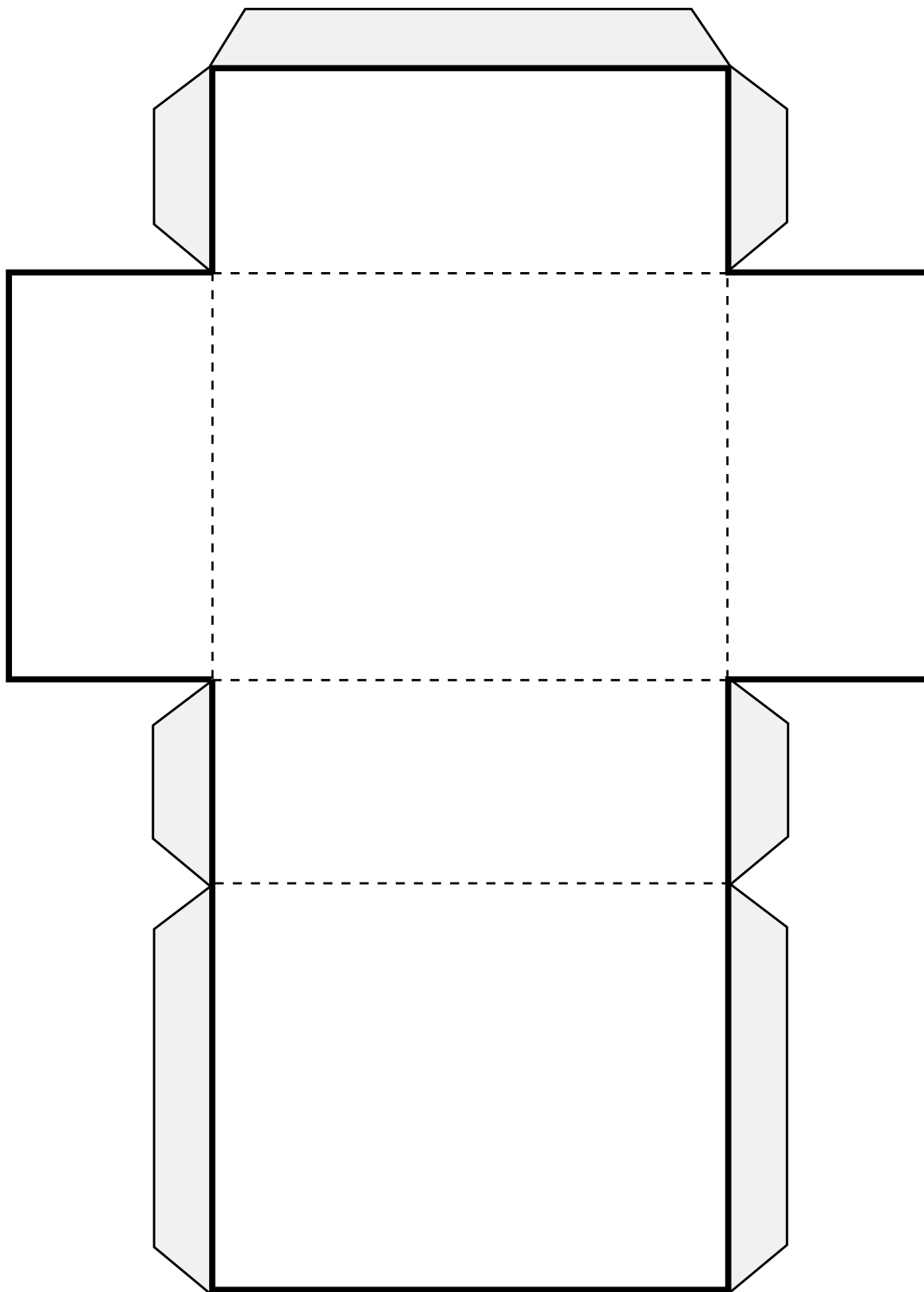

Prisme à base triangulaire

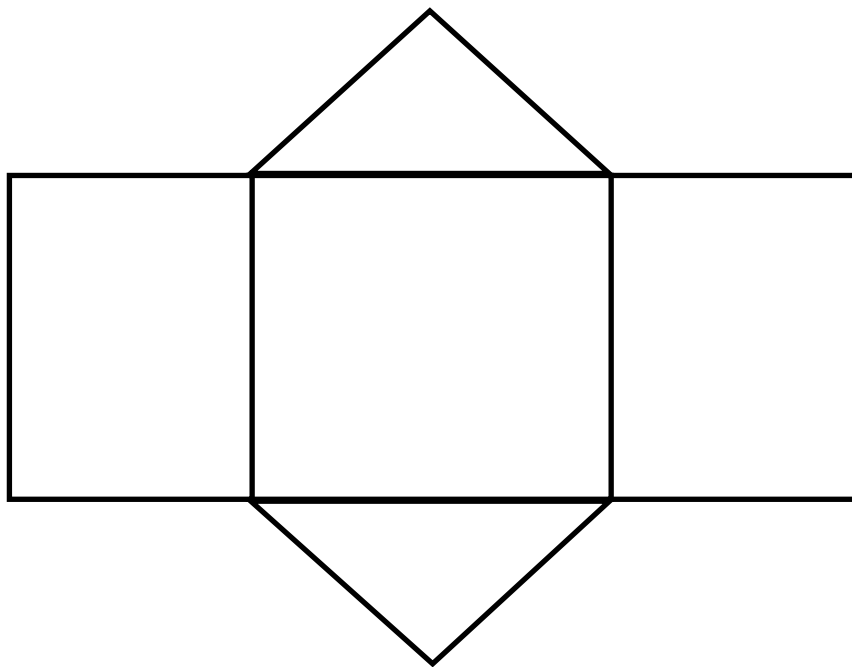
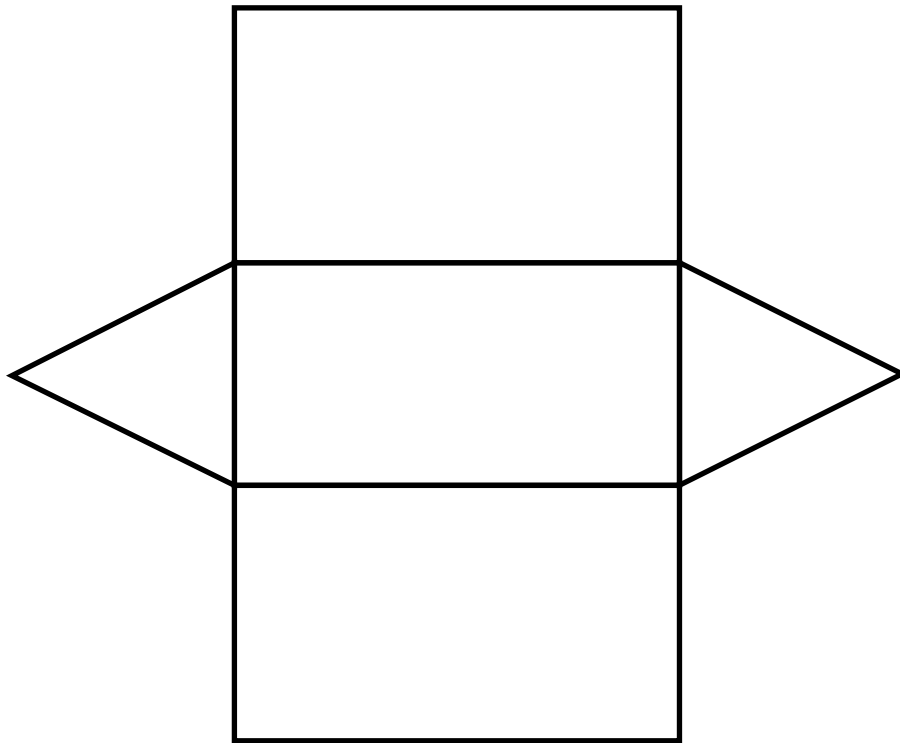

Prisme à base triangulaire

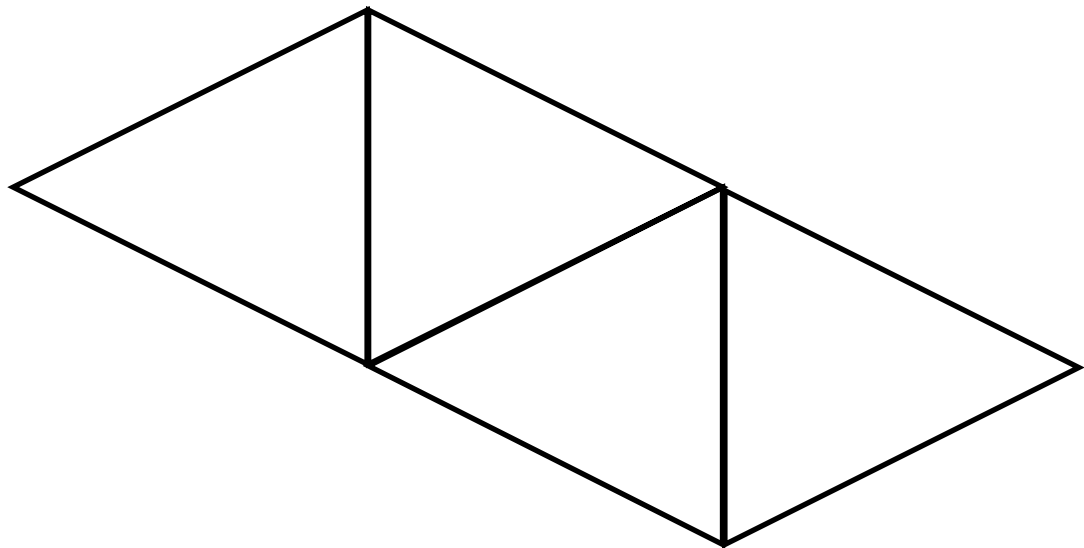
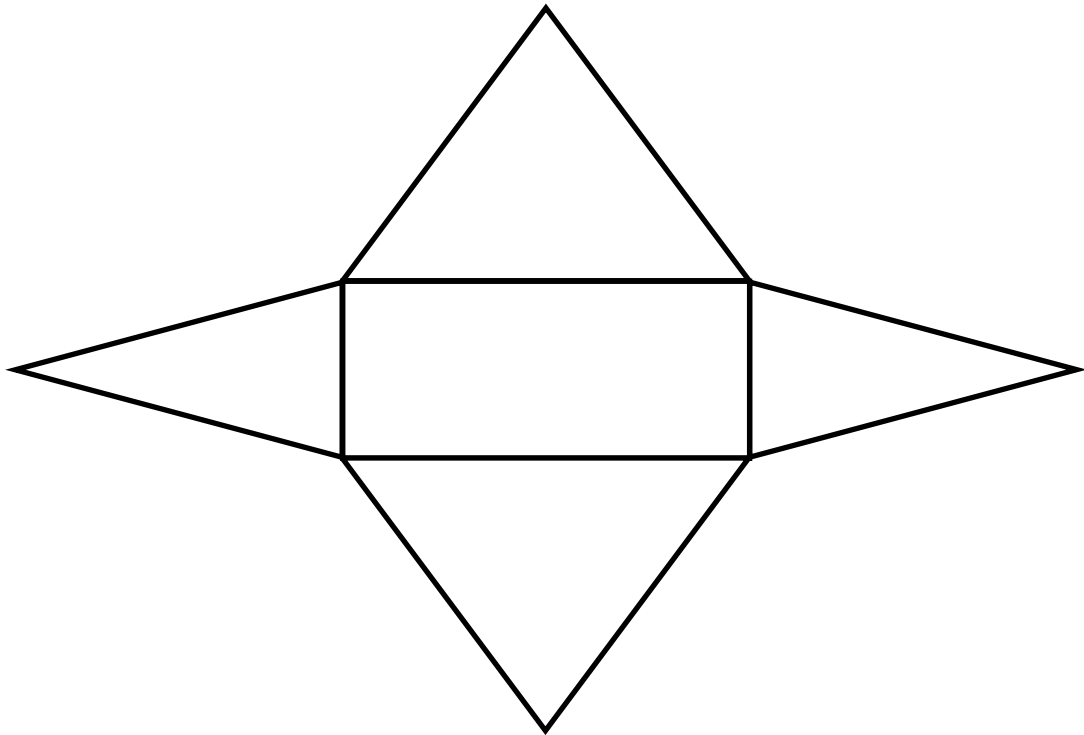

Prisme à base triangulaire

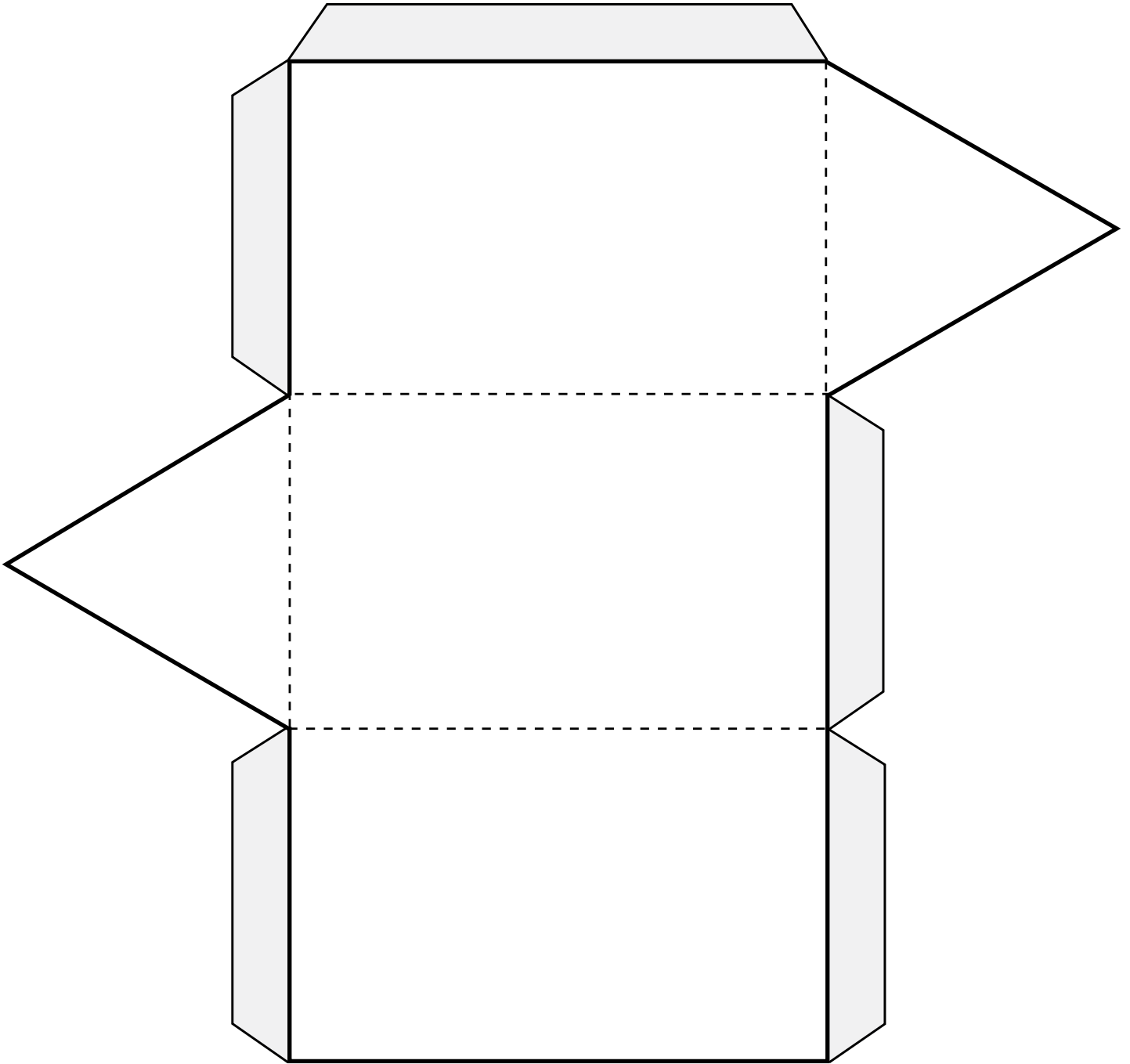

Droites numériques (horizontales)

0 à 100 avec graduations accentuées et chacun des nombres de 0 à 100

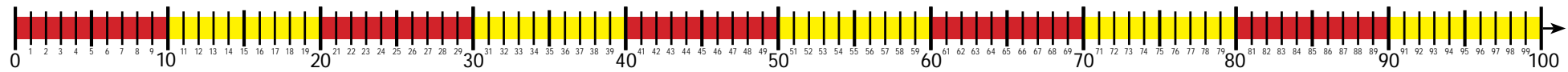
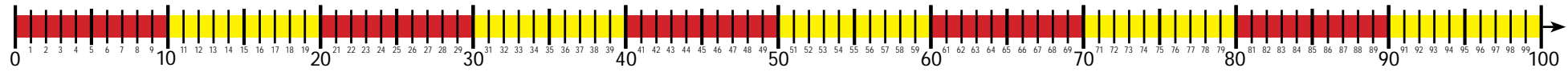
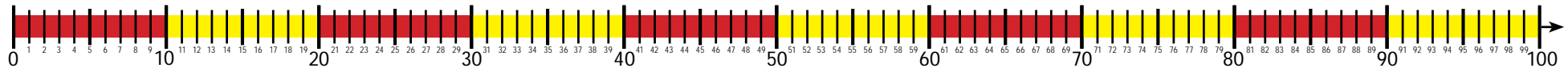

Droites numériques (horizontales)

0 à 100 avec graduations accentuées et nombres montrant les multiples de 10

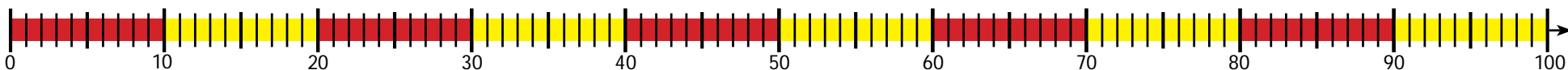
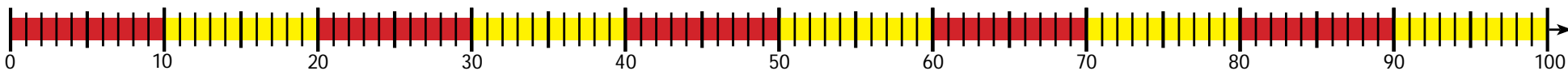
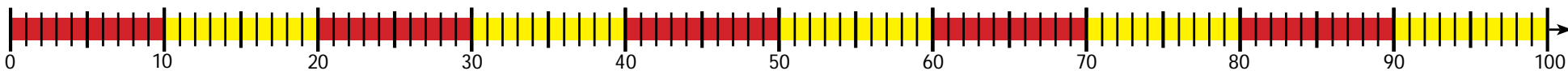

Droites numériques (horizontales)

vide avec graduations accentuées



Droites numériques (horizontales)

vide avec nombre réduit de graduations accentuées



Droites numériques (horizontales) ouverte

Table des matières



Liste FR

Ma boîte à outils en mathématiques



Droites numériques (horizontales) avec points de repère variés

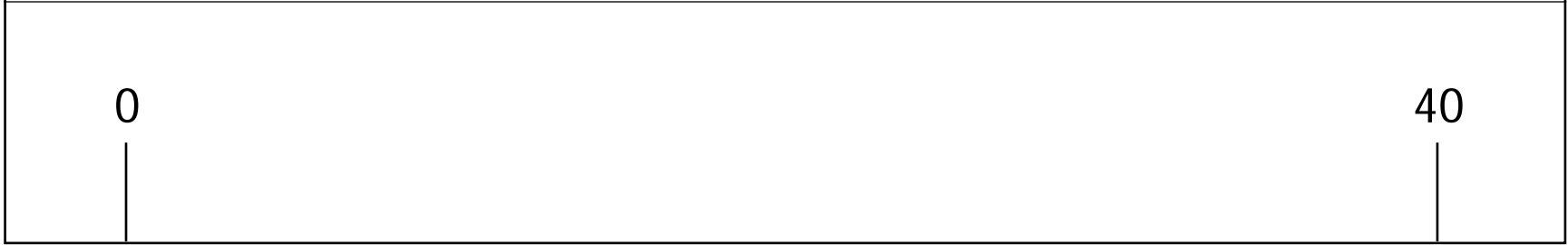
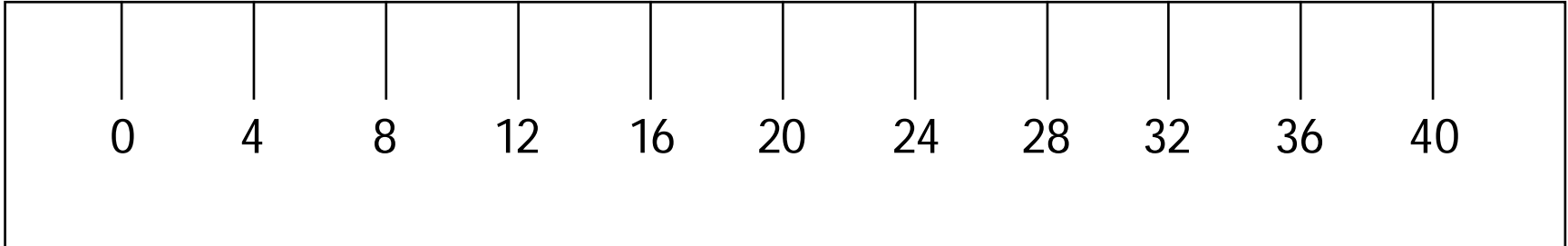

Replier

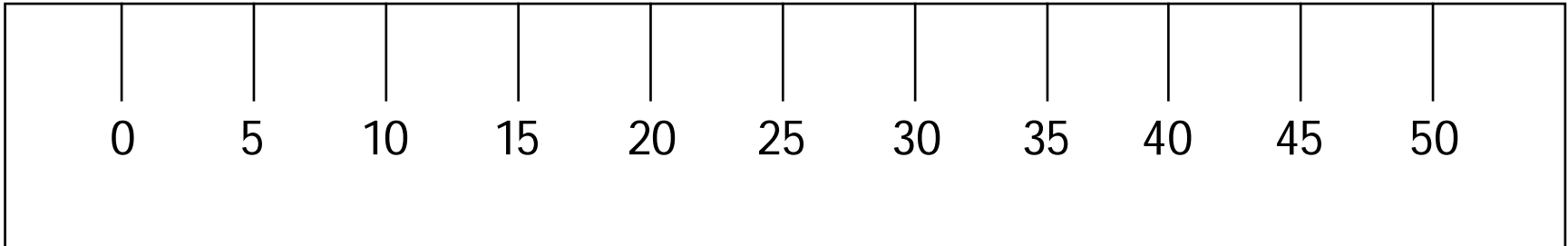

Replier



Droites numériques (horizontales)

avec points de repère variés

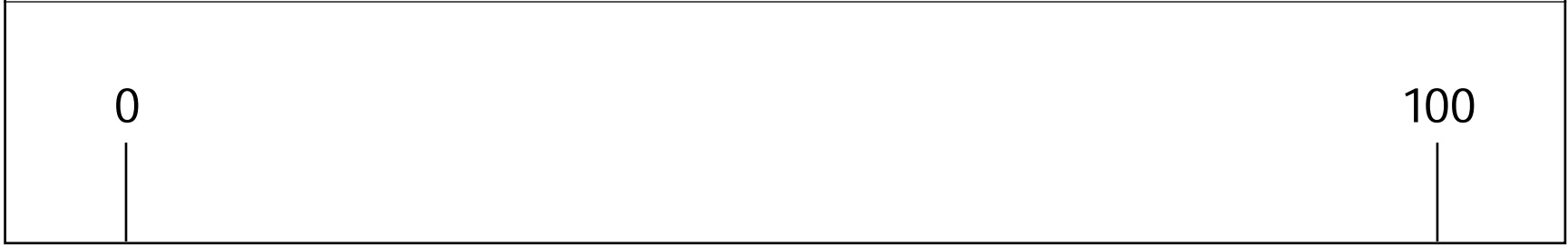
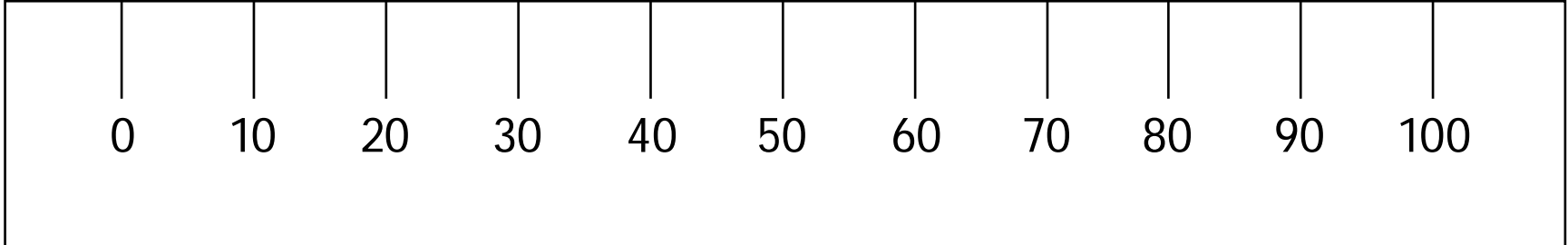

Replier

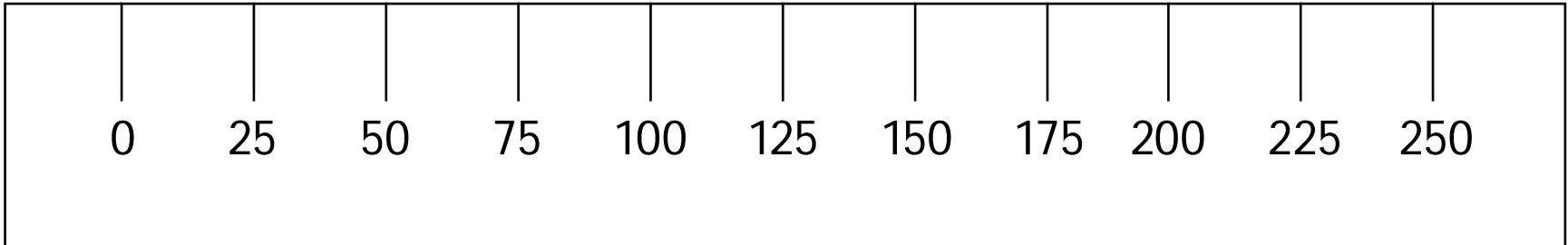

Replier



Droites numériques (horizontales)

avec points de repère variés

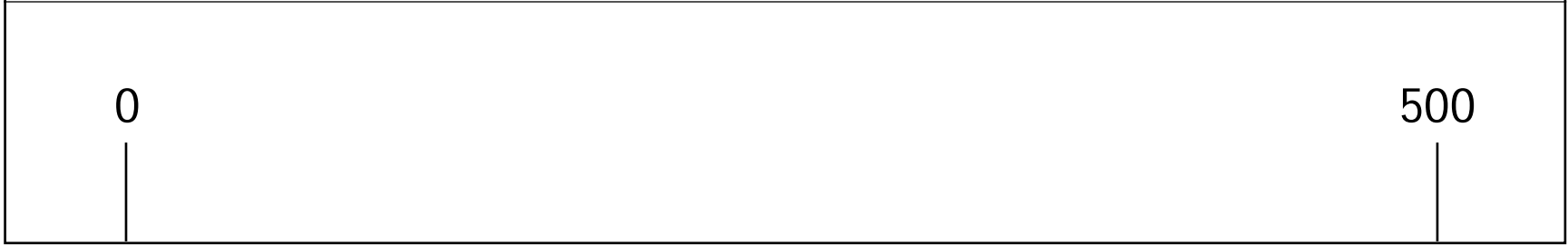
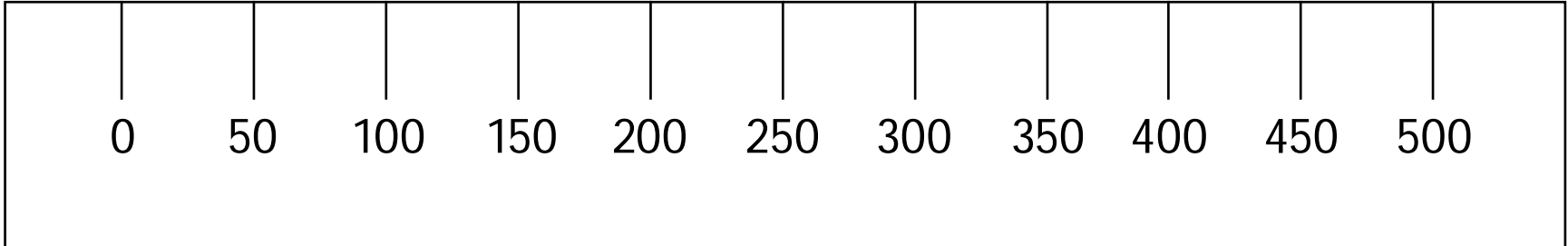

Replier

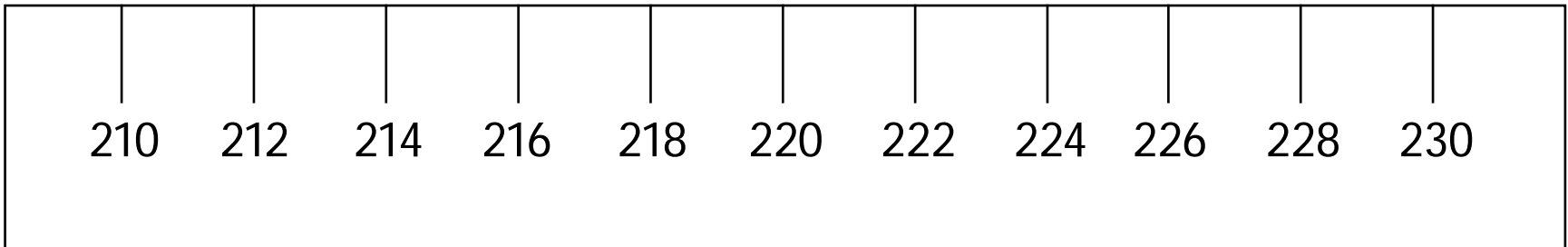

Replier



Droites numériques (horizontales) vides



Replier



Replier



Droites numériques (verticale)

0 à 100 avec graduations accentuées et chacun des nombres de 0 à 100

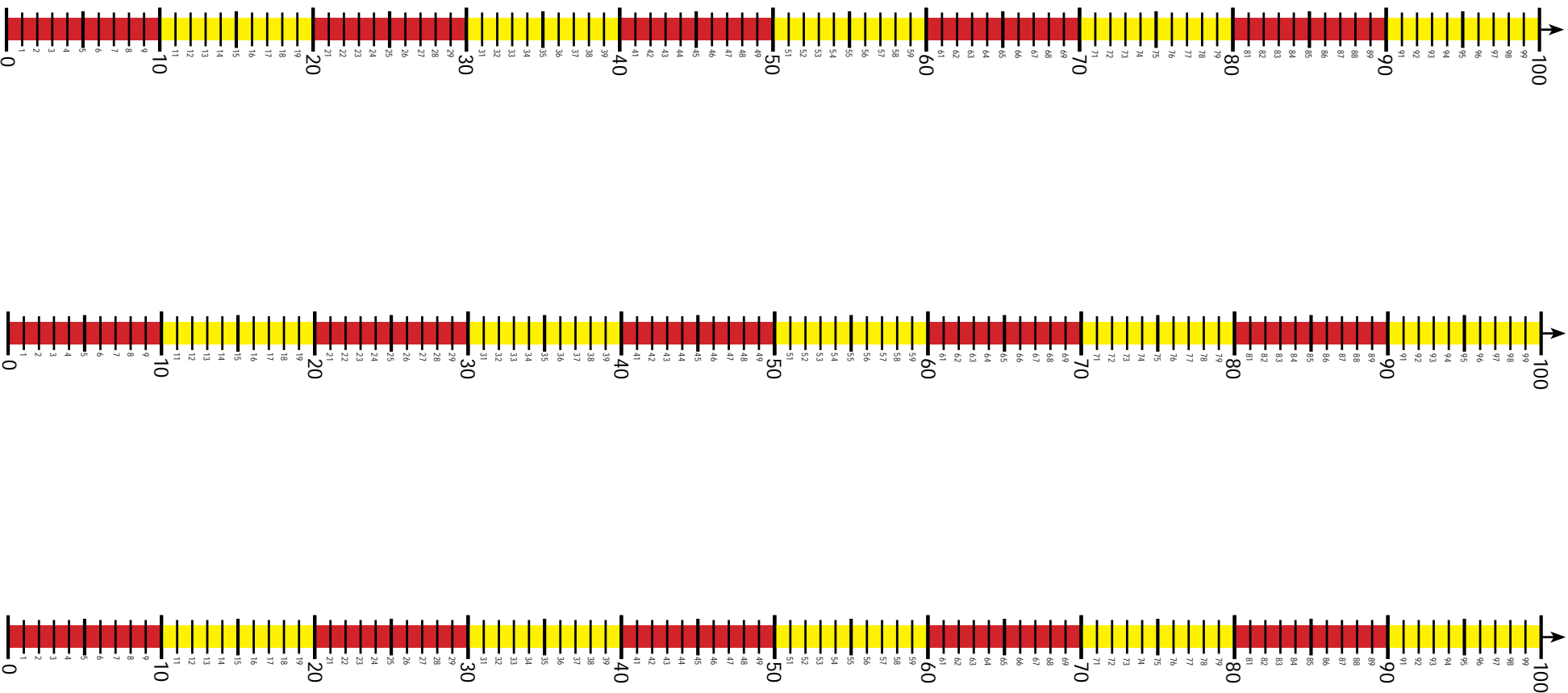

Droites numériques (verticales)

0 à 100 avec graduations accentuées et nombres montrant les multiples de 10

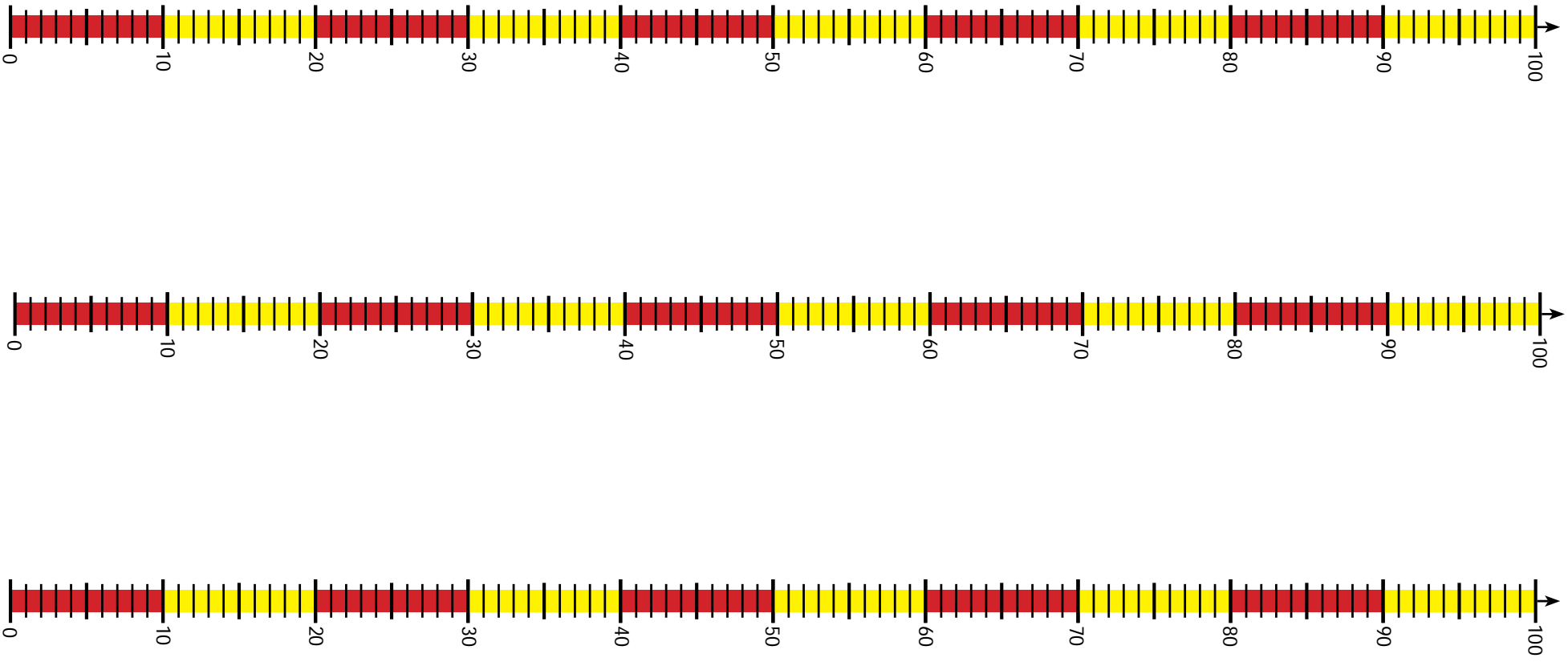

Droites numériques (verticales)

vide avec graduations accentuées



Droites numériques (verticales)

vide avec nombre réduit de graduations accentuées



Droites numériques (verticales) ouverte

Table des matières



Liste FR

Ma boîte à outils en mathématiques



293



Ensemble de dominos (Total de points jusqu'à 12)

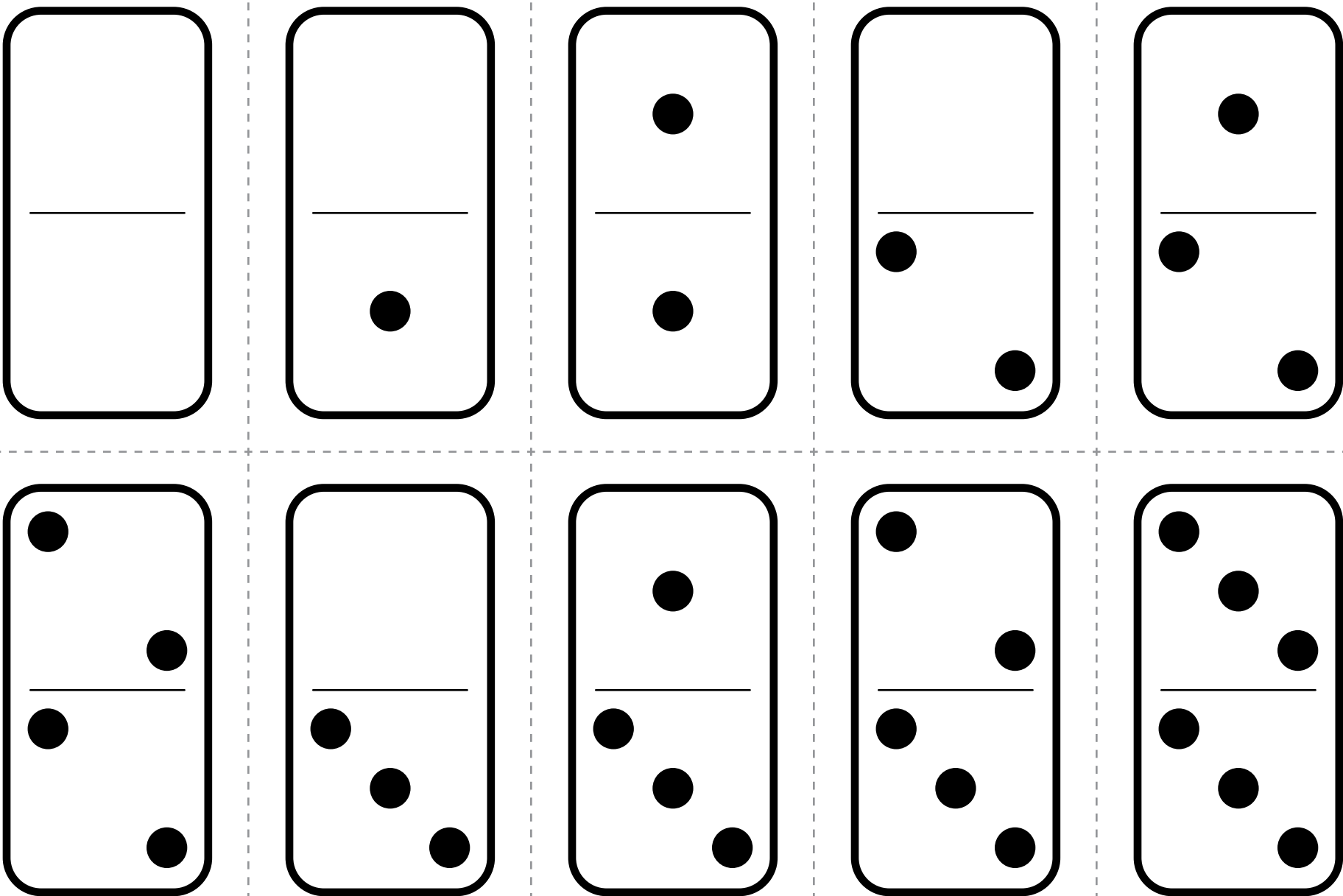

Ensemble de dominos (Total de points jusqu'à 12) (suite)

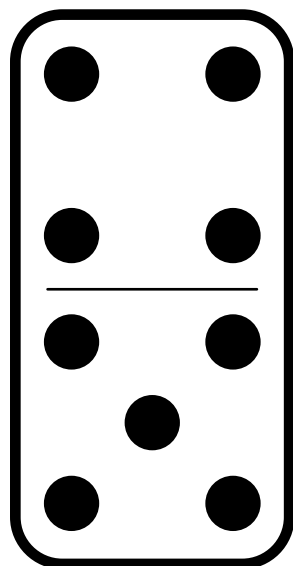
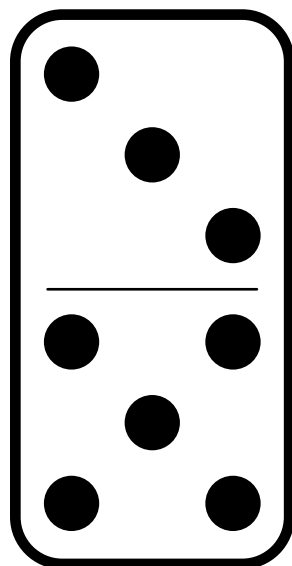
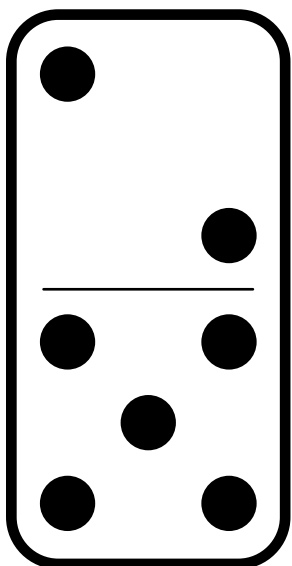
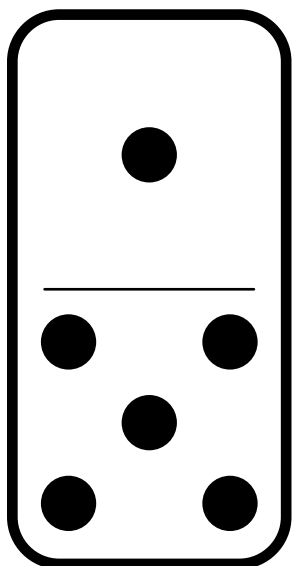
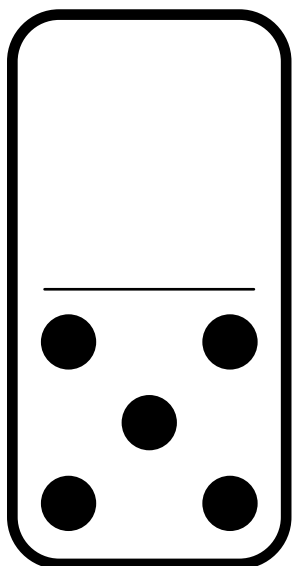
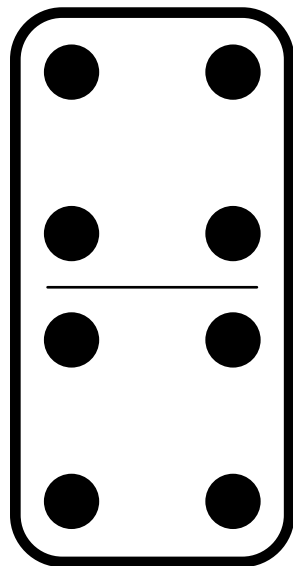
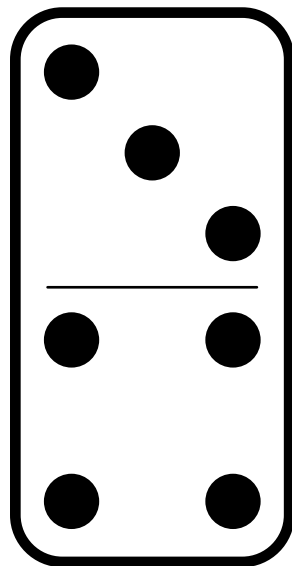
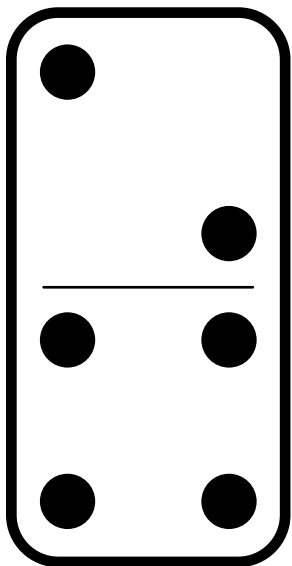
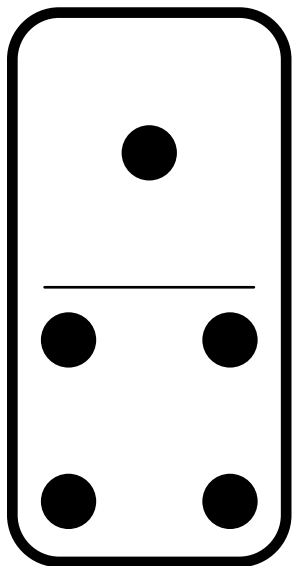
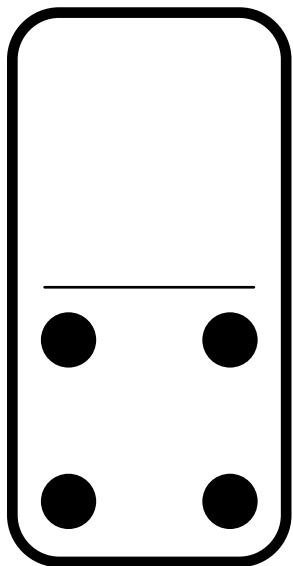

Ensemble de dominos (Total de points jusqu'à 12) (suite)

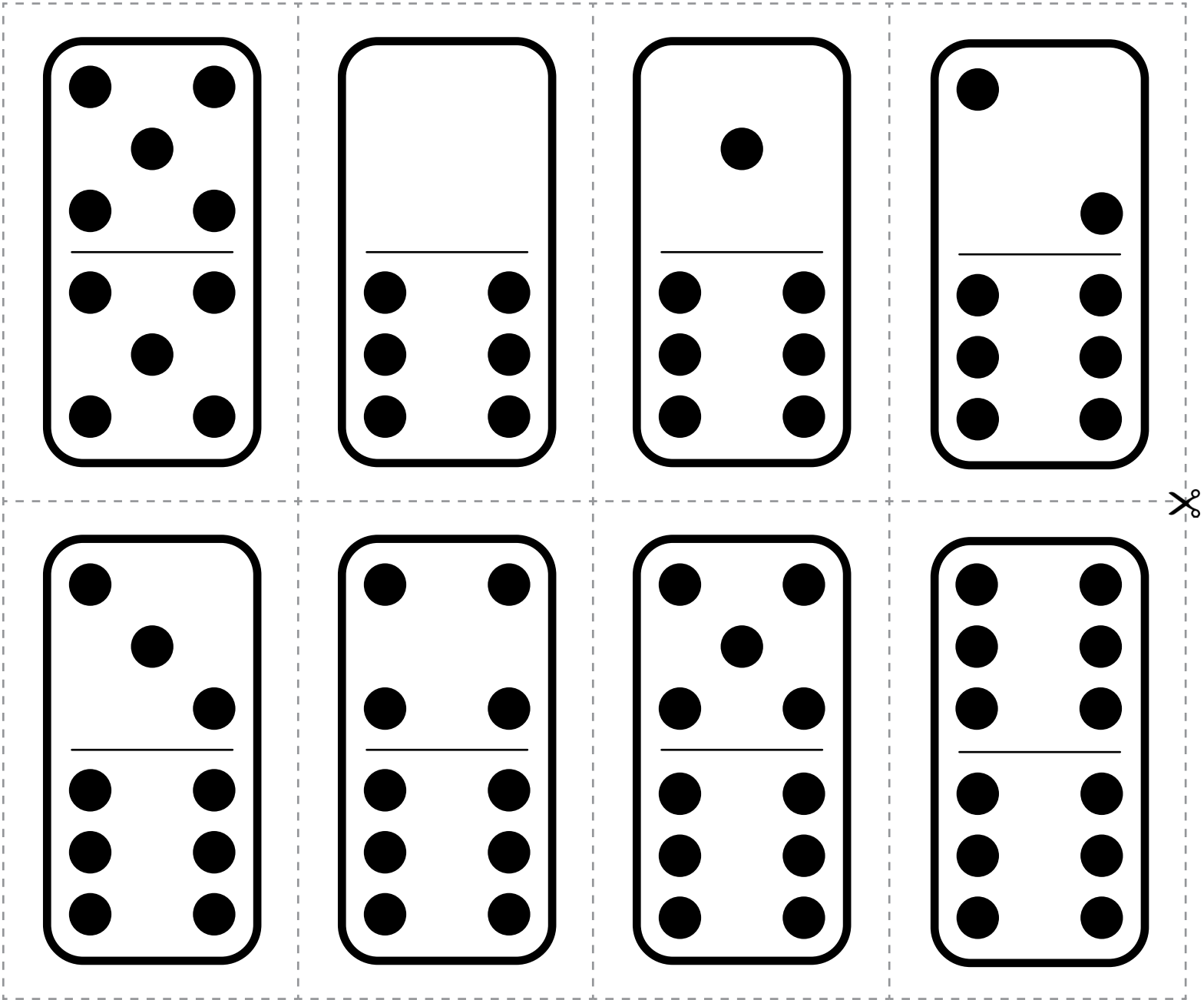

Ensemble de polygones réguliers

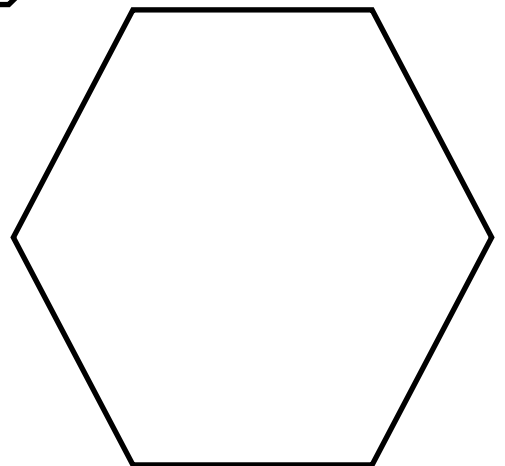
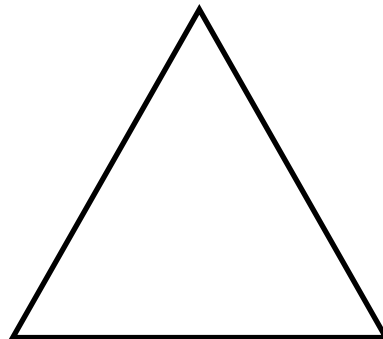
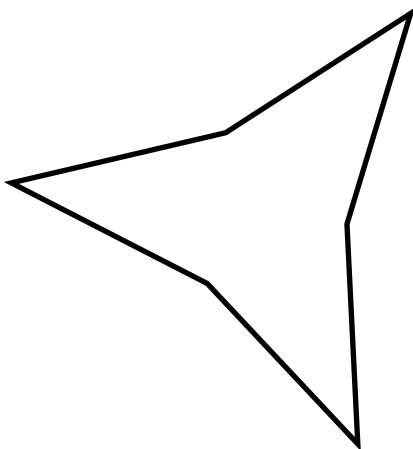
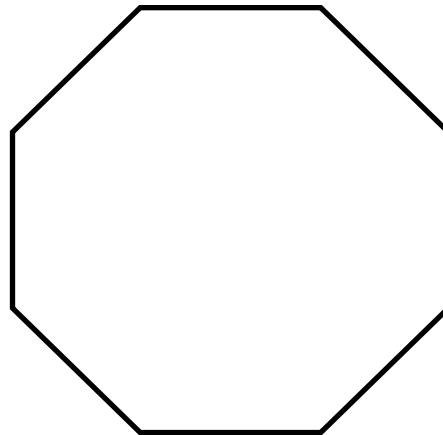
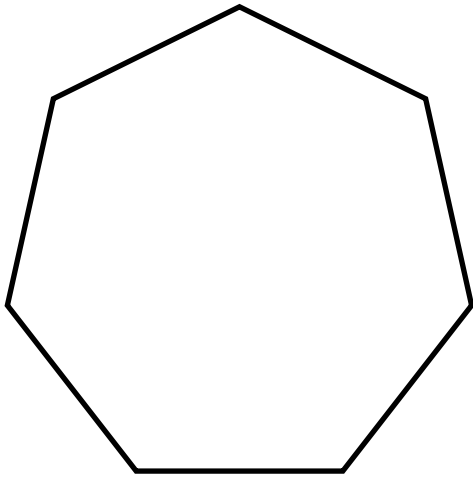
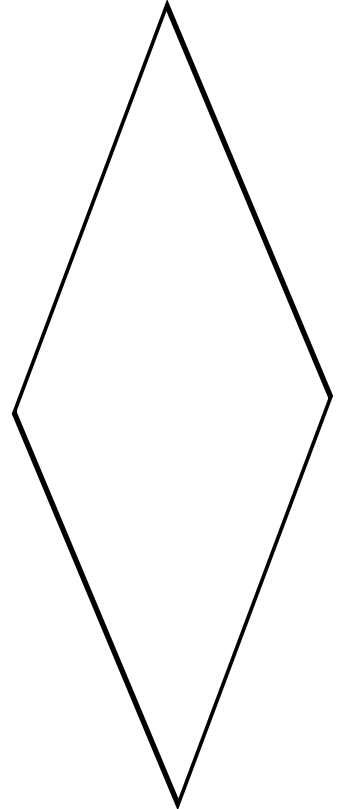
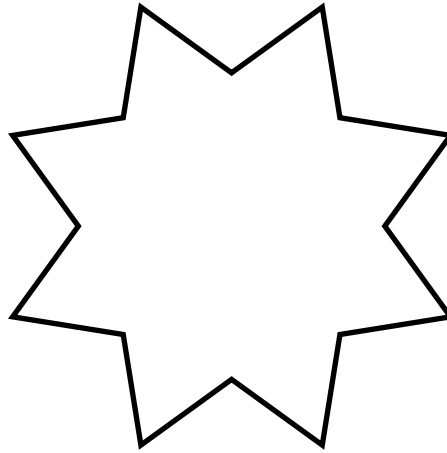
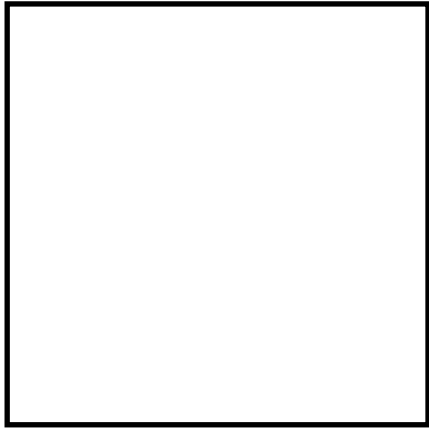

Ensemble de polygones irréguliers

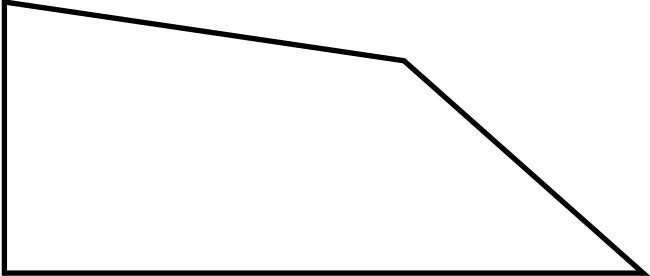
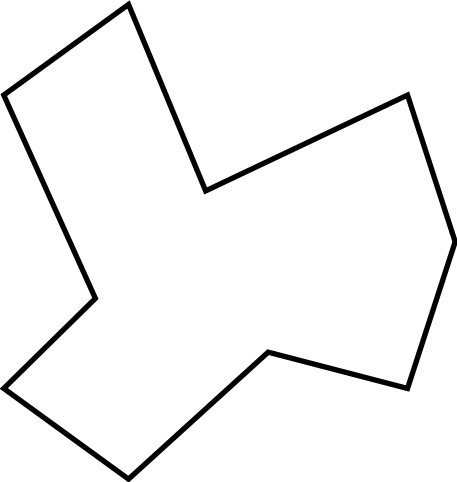
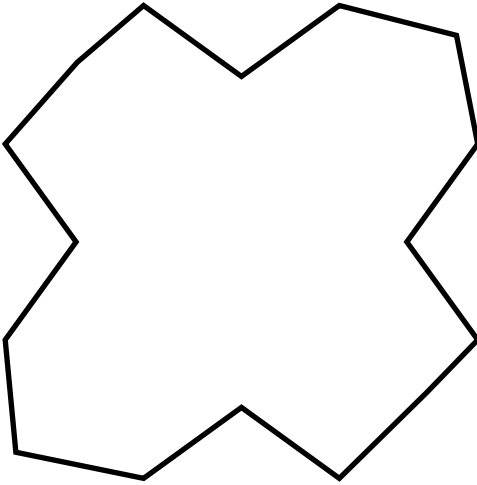
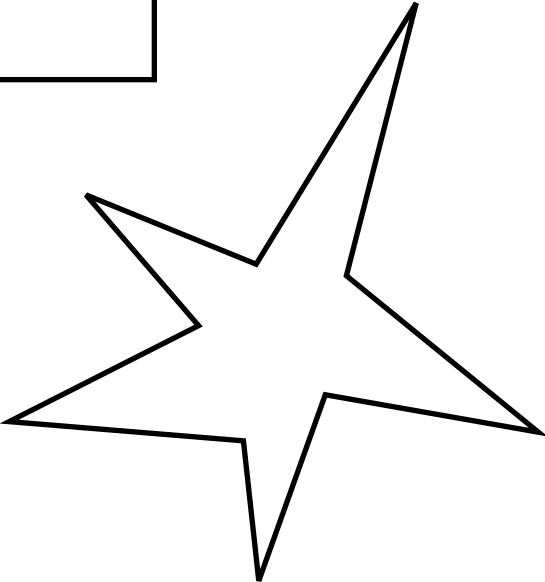
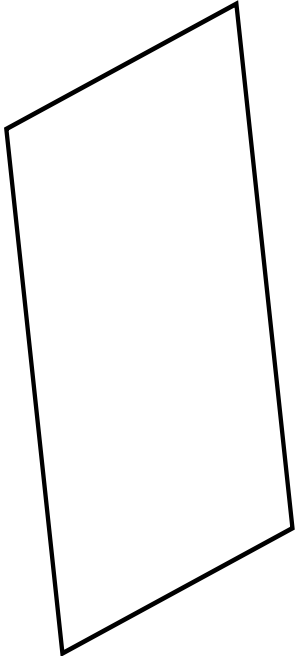

Éventail (0 à 9) avec décimales

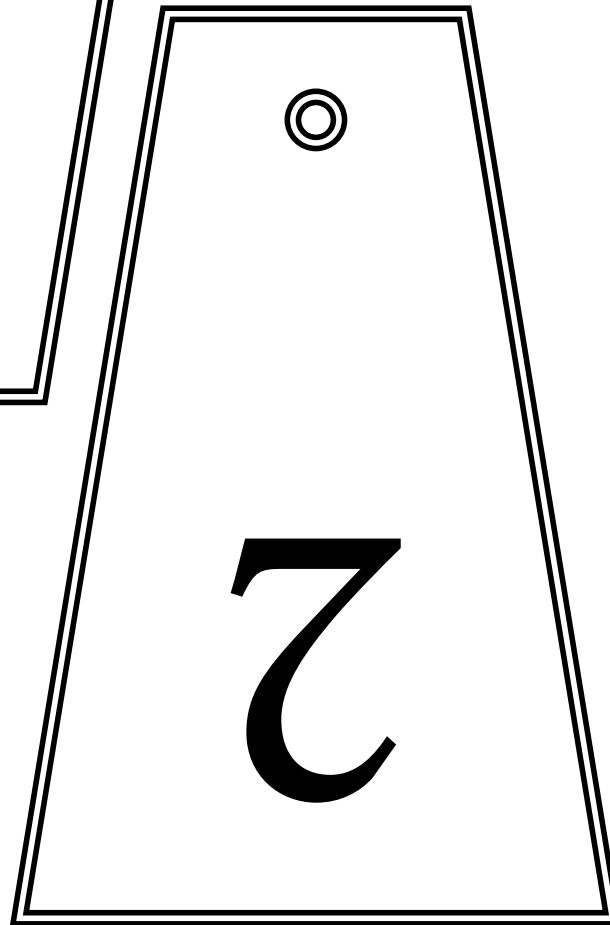
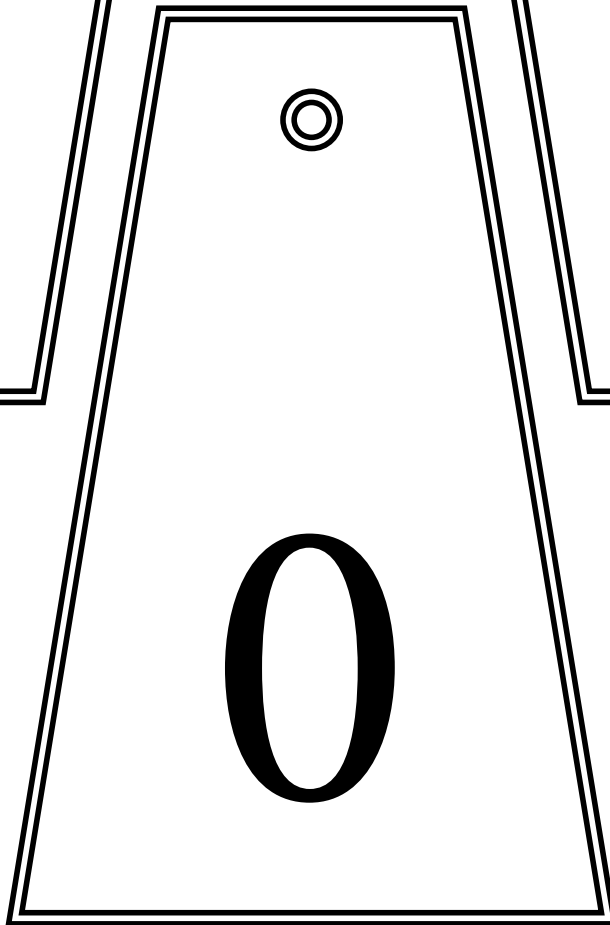
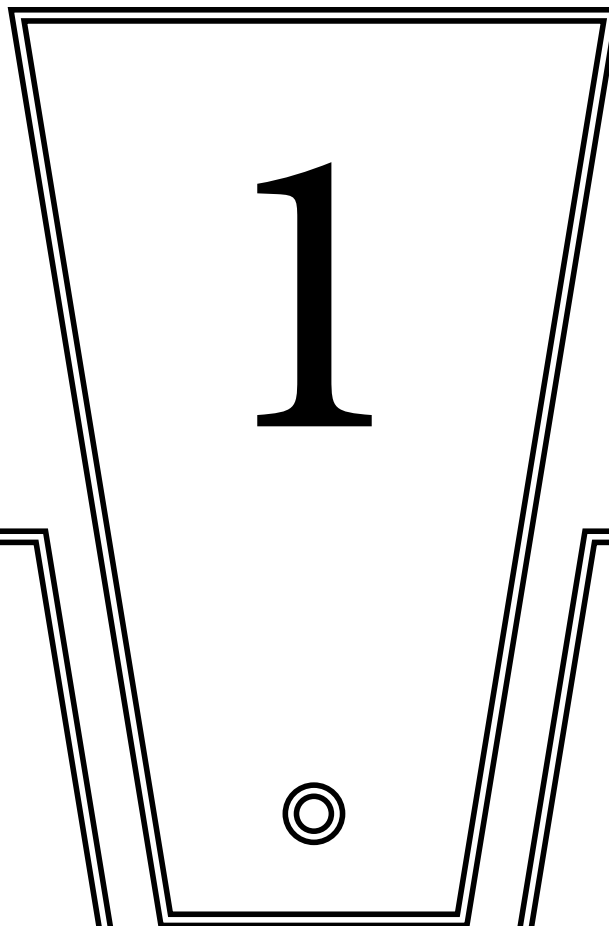
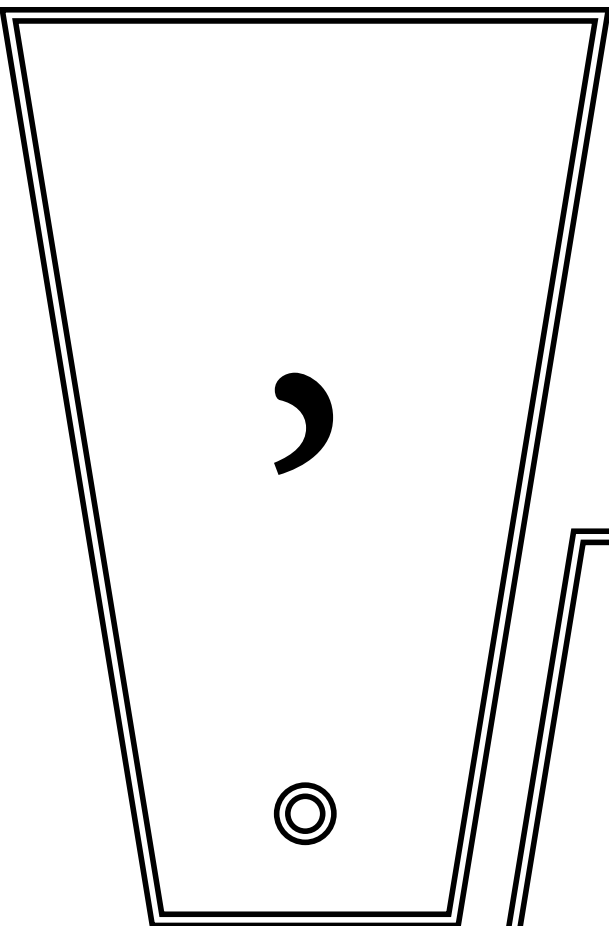

**Éventail (0 à 9)
avec décimales
(suite)**

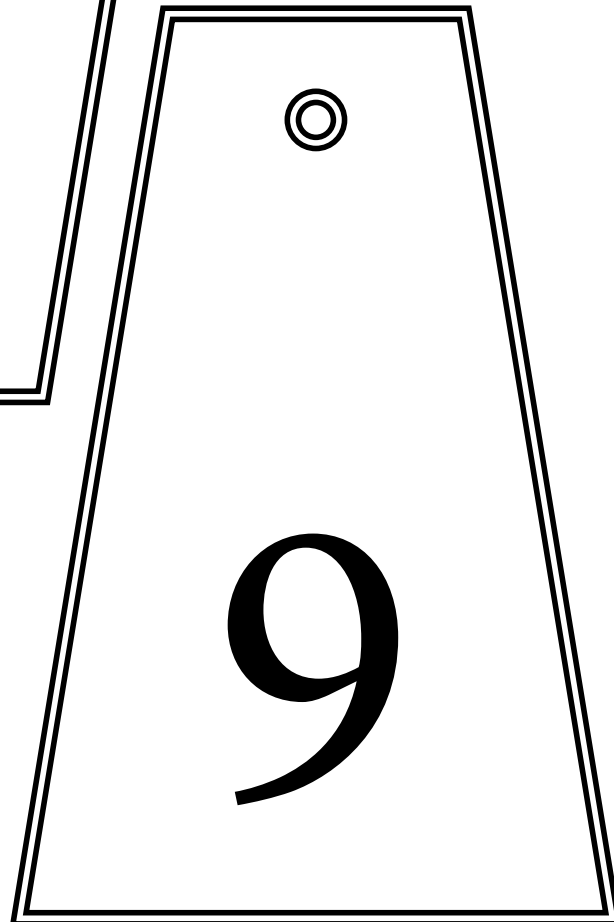
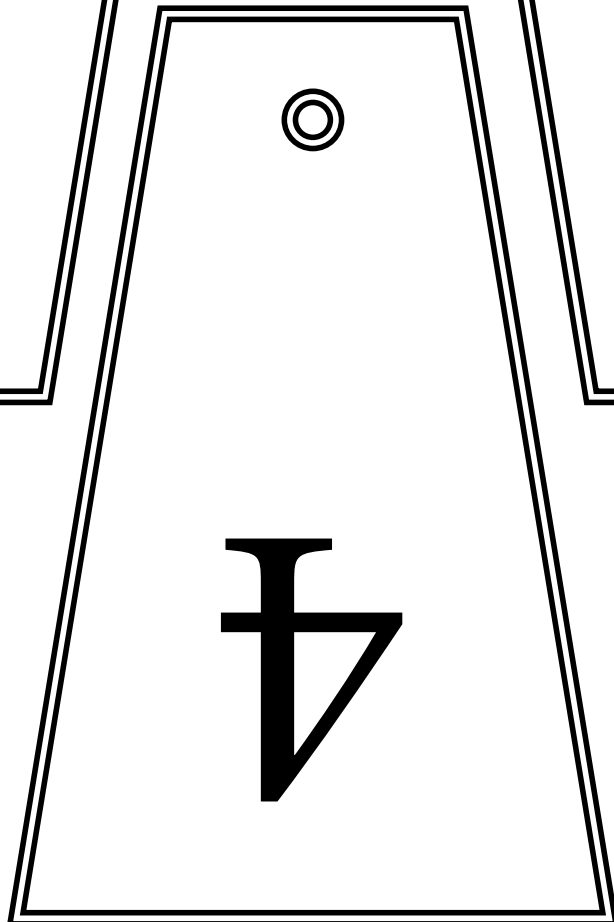
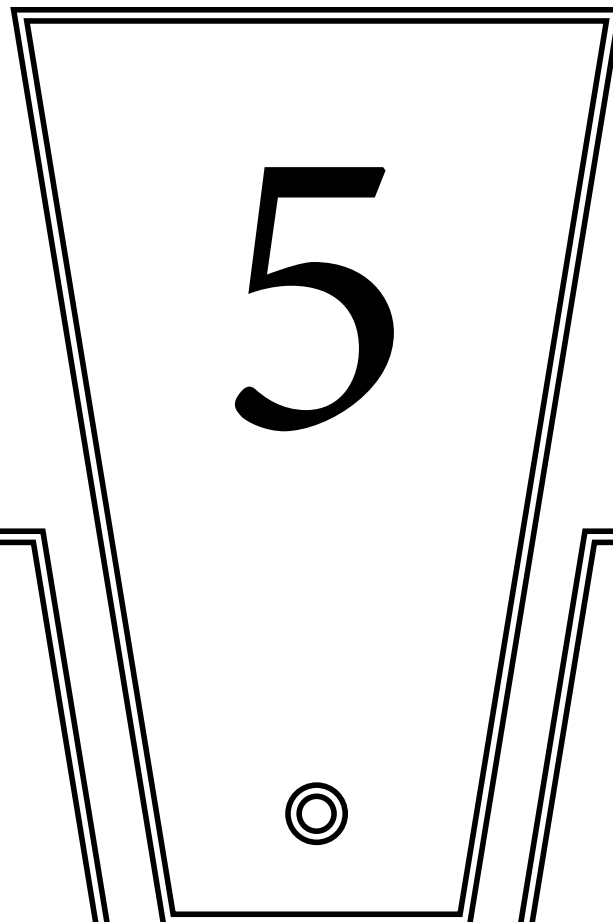
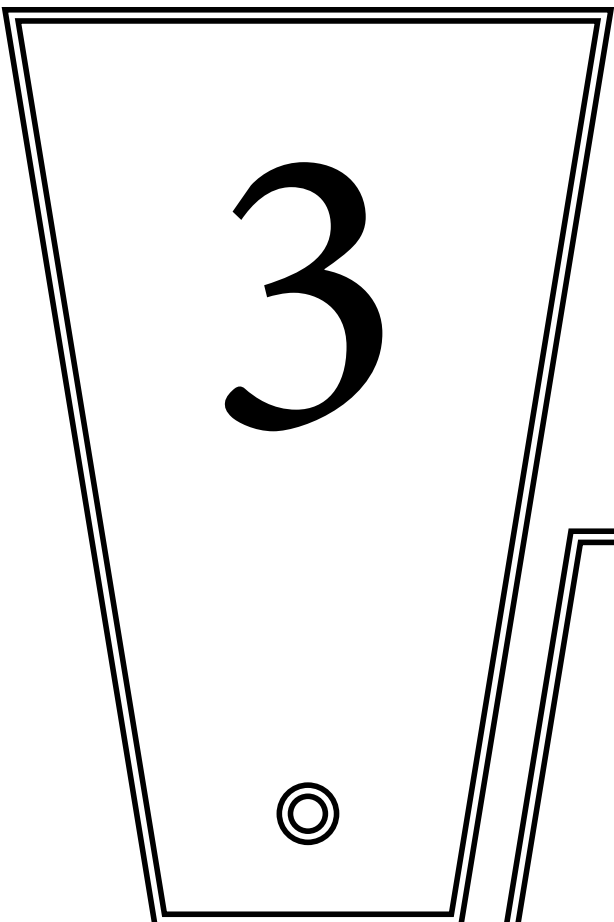

**Éventail (0 à 9)
avec décimales**
(suite)

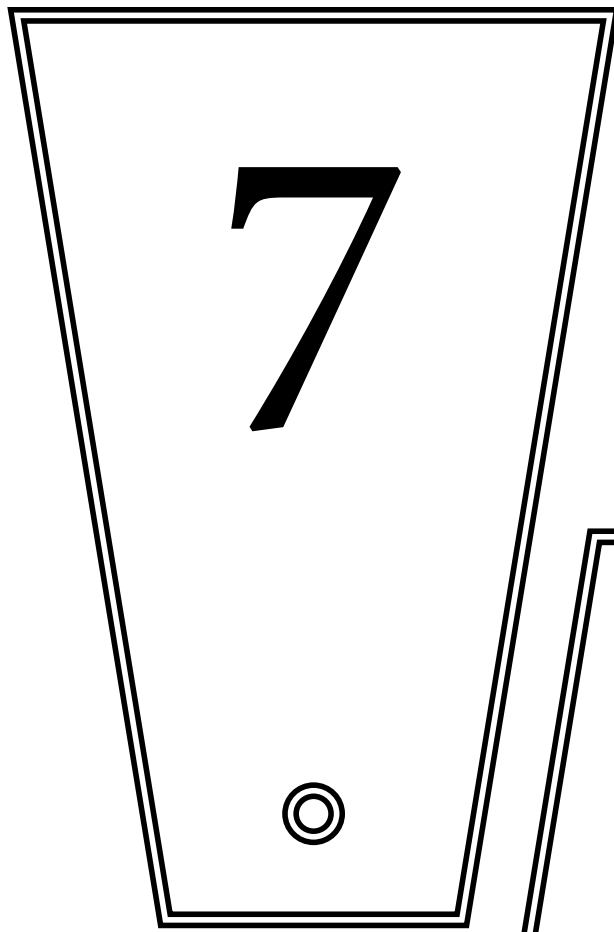
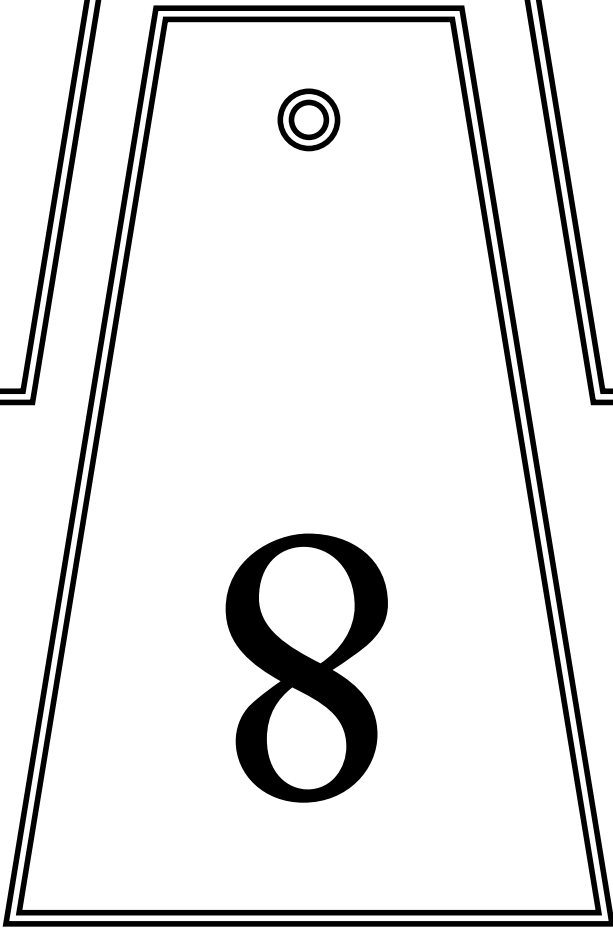
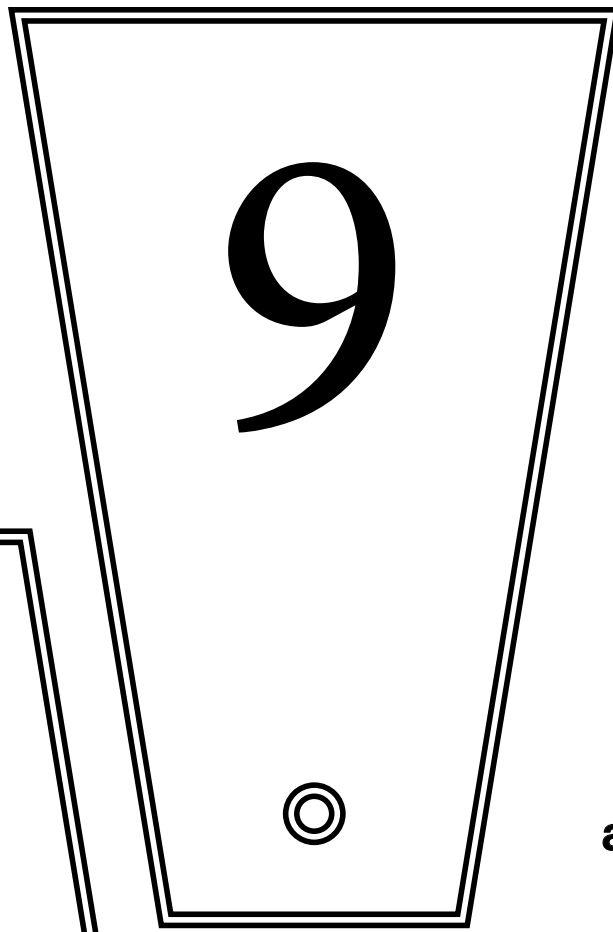

Palette (0 à 9) avec décimales

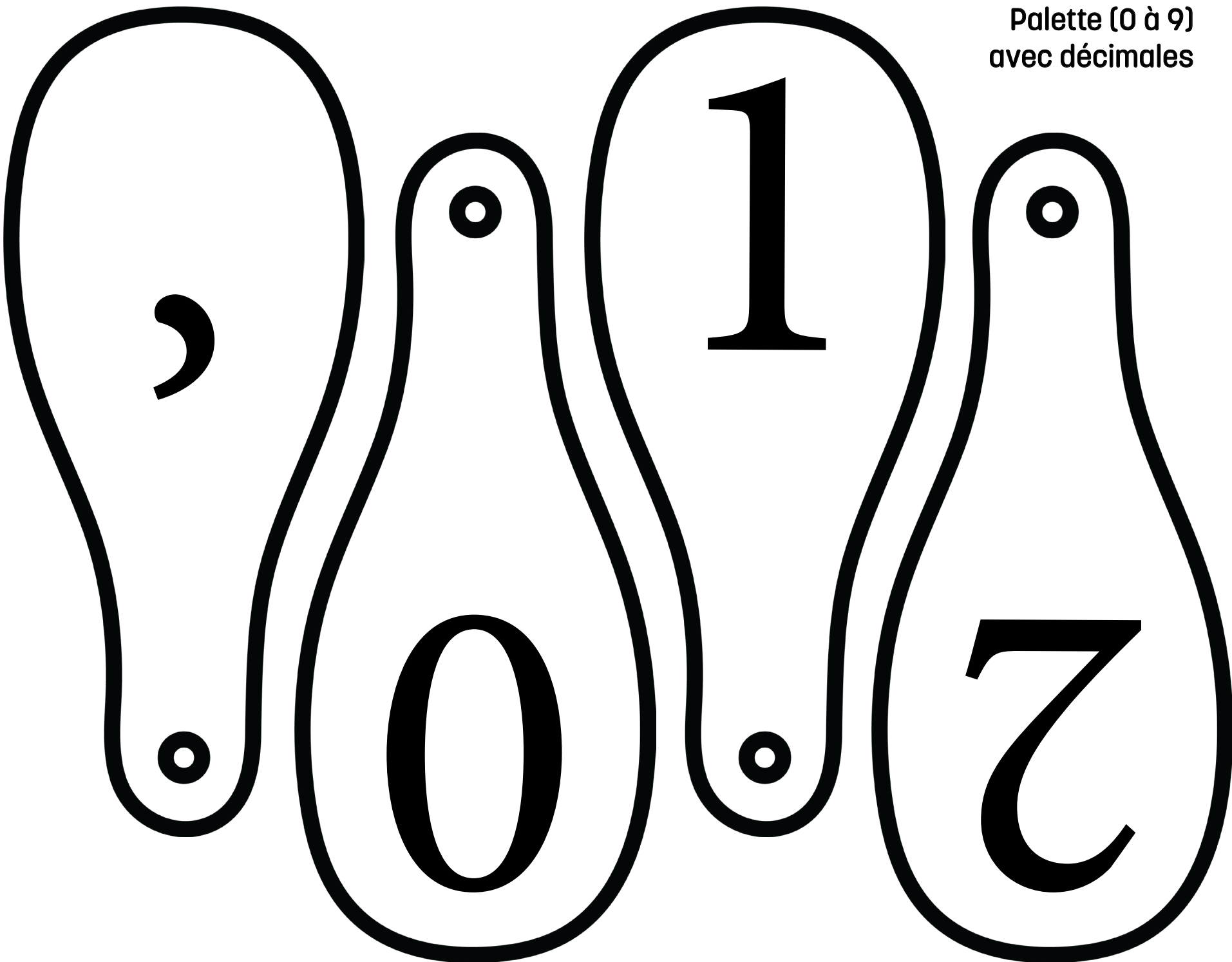

Palette (0 à 9)
avec décimales
(suite)

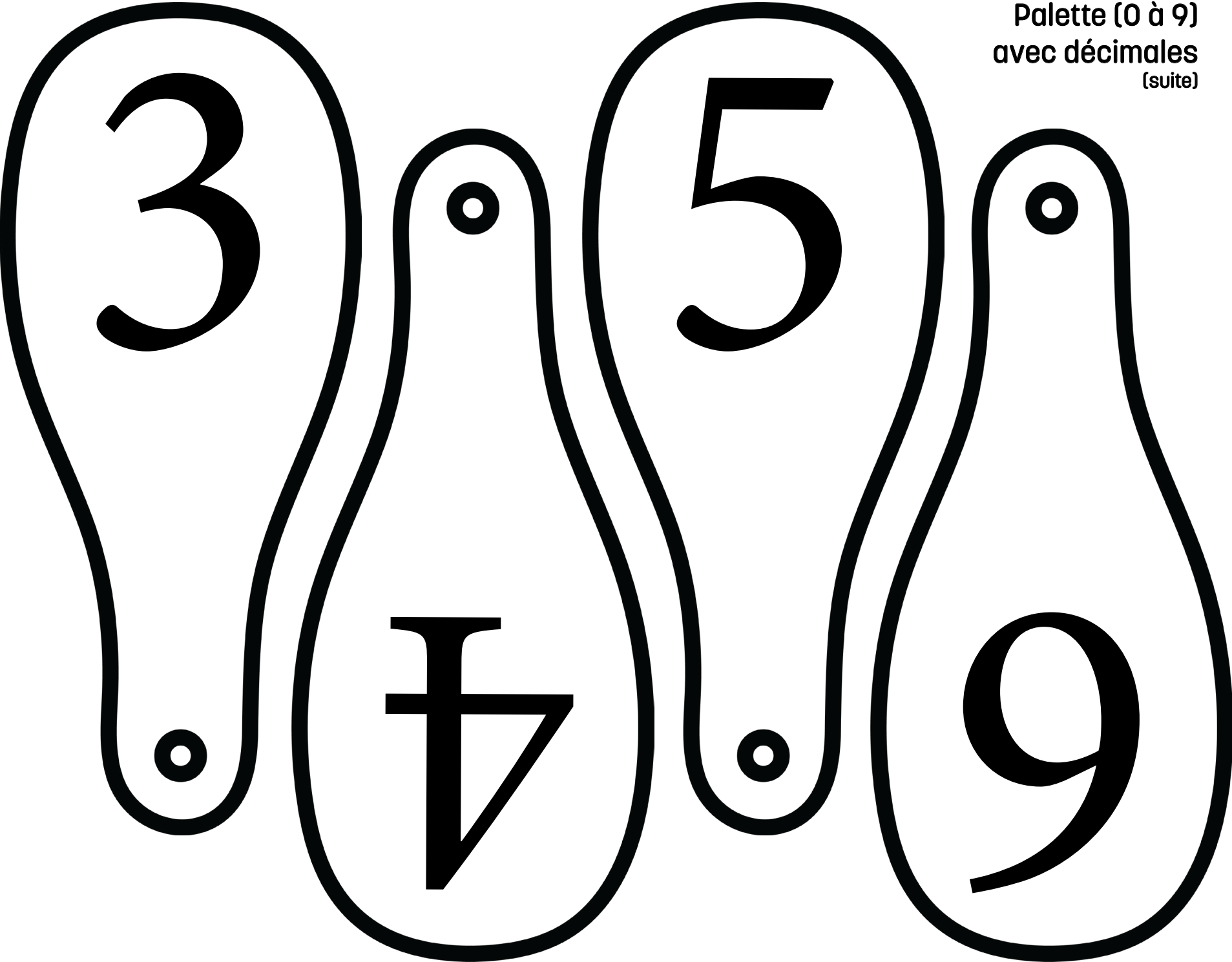

Palette (0 à 9)
avec décimales
(suite)

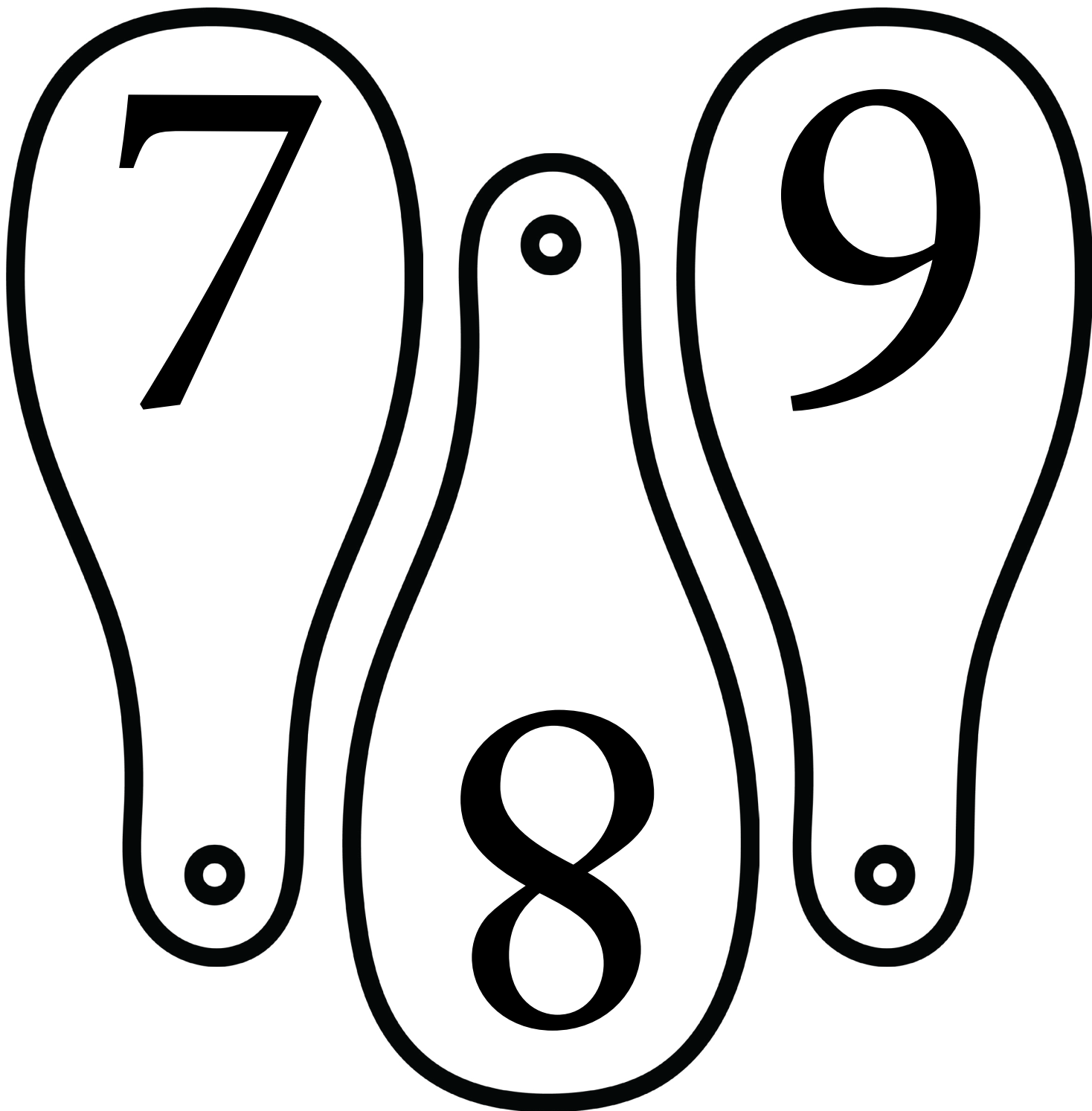

Palette (0 à 10) de cartes à 10 points

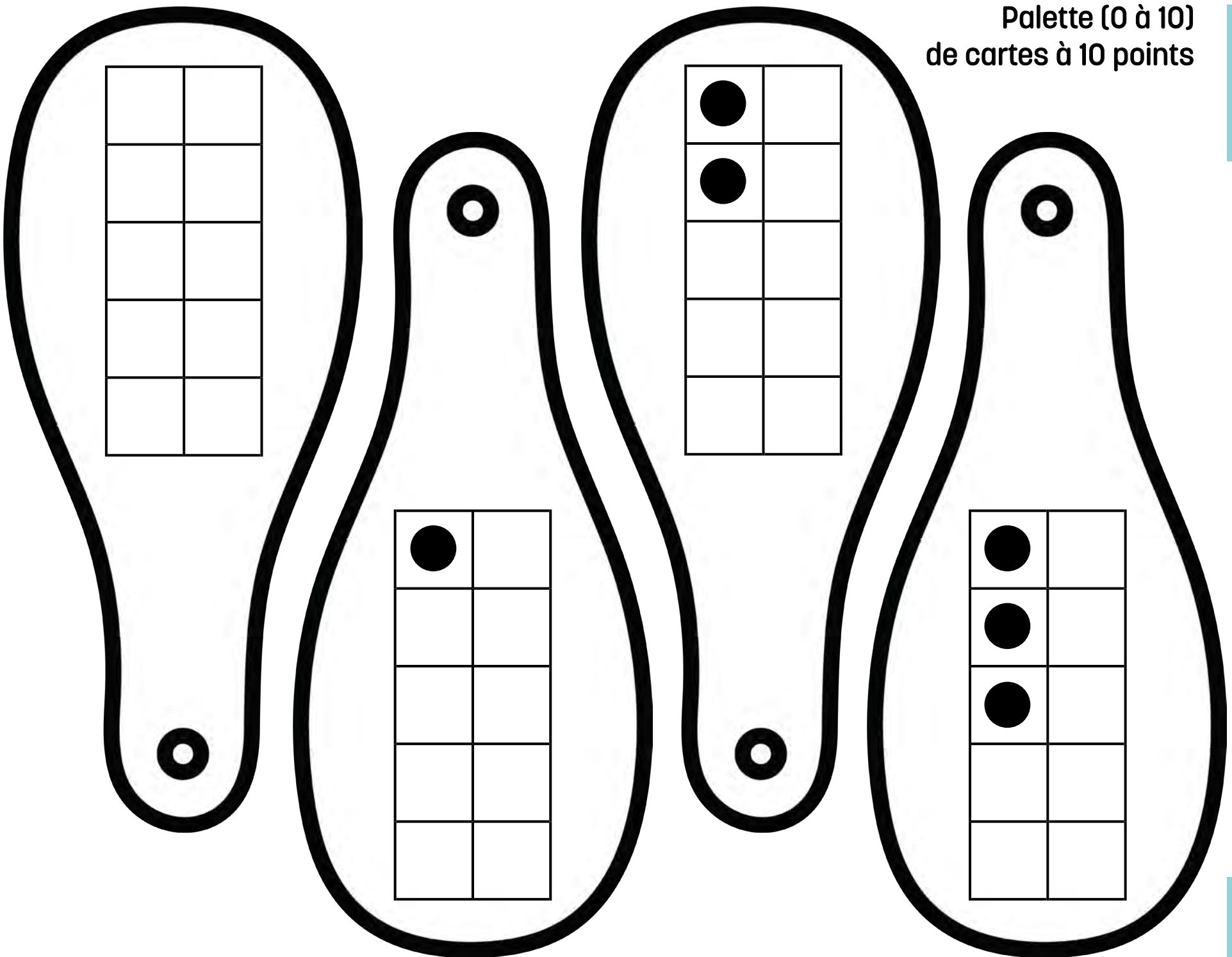

Palette (0 à 10) de cartes à 10 points (suite)

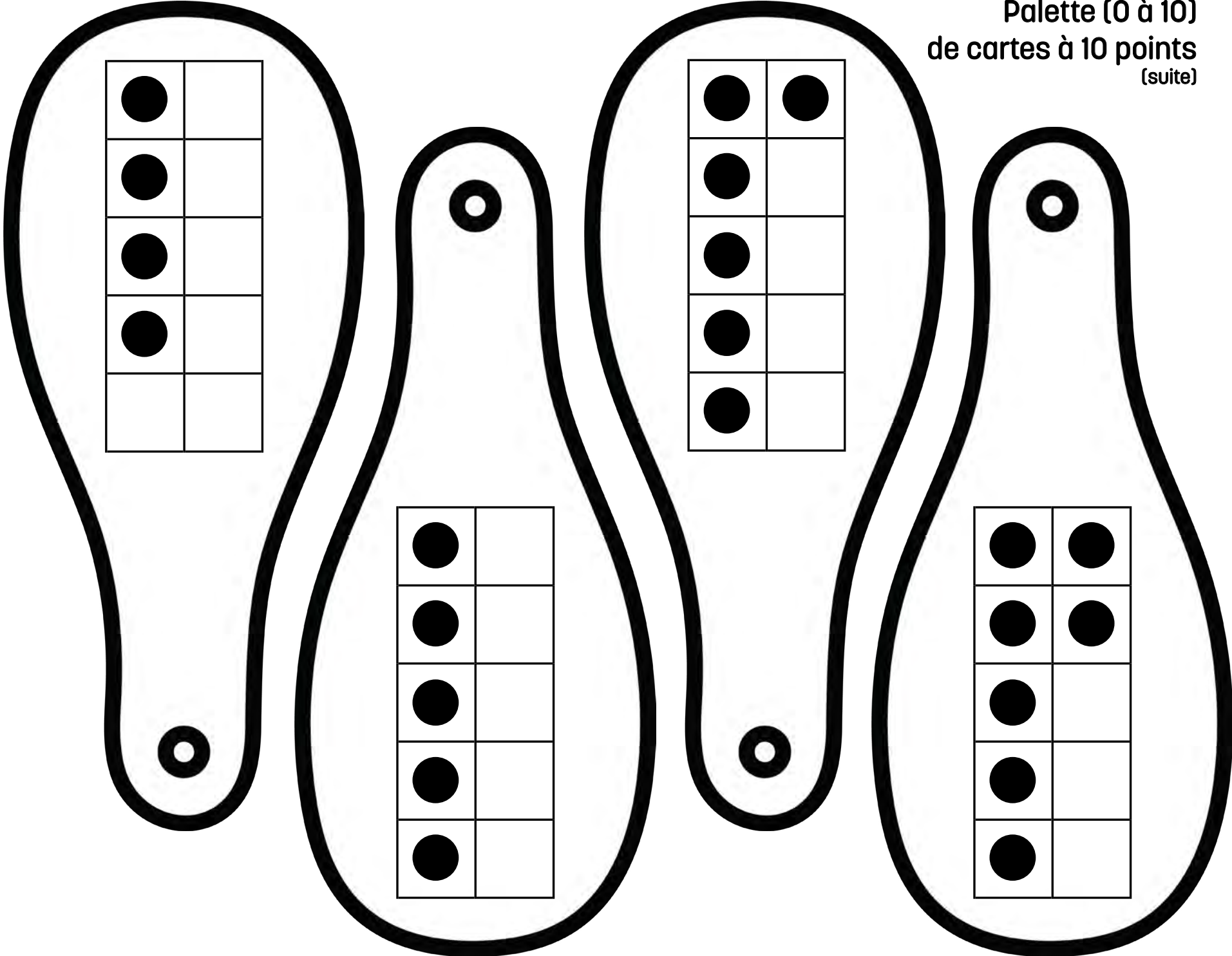

●	
●	
●	
●	

●	●
●	
●	
●	
●	

●	
●	
●	
●	
●	
●	

●	●
●	●
●	
●	
●	
●	



Palette (0 à 10)
de cartes à 10 points
(suite)

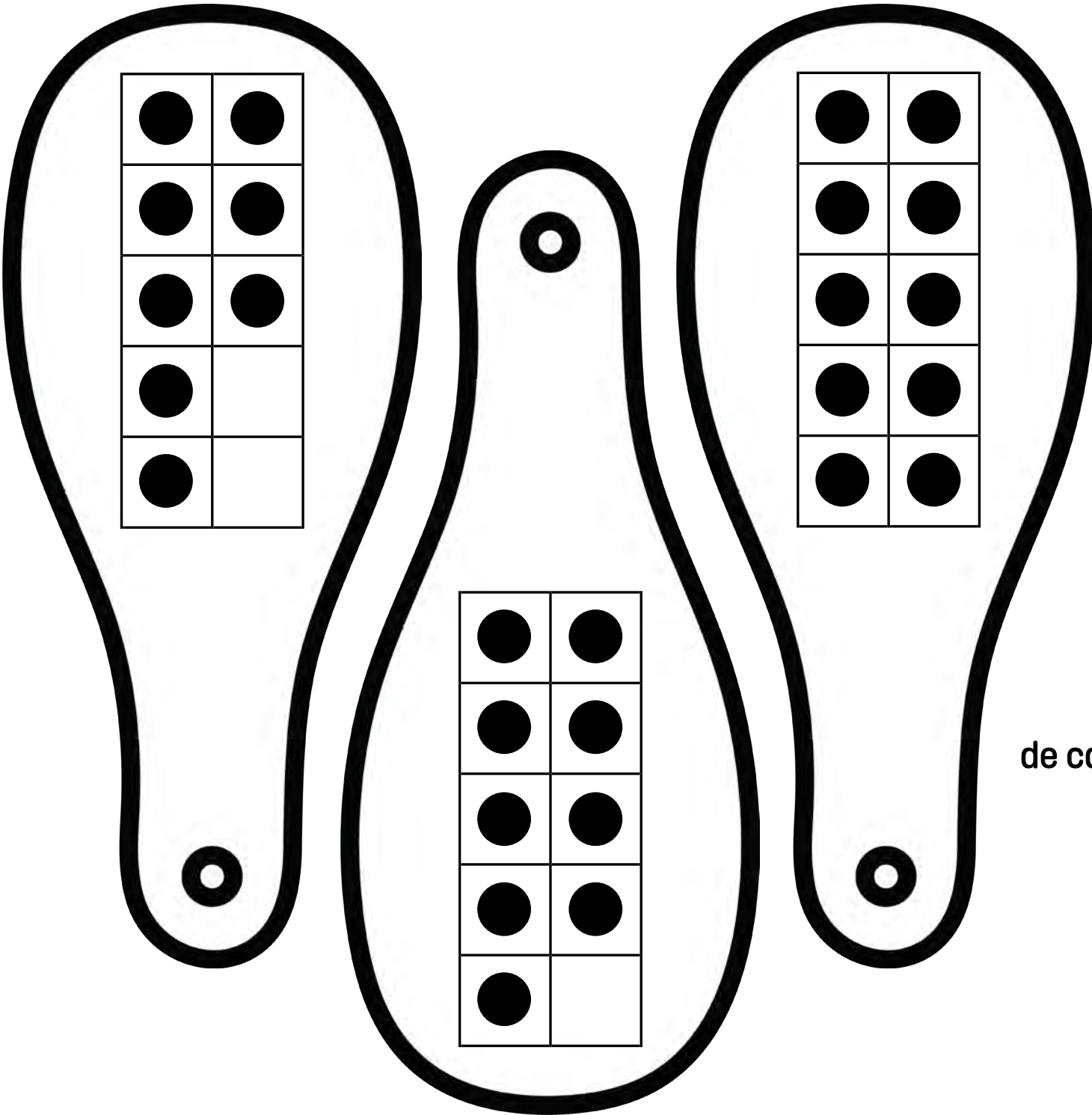

Bande numérique de 1 à 10 représentations imagée et symboliques

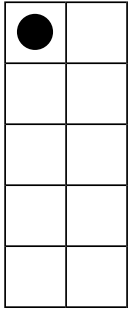
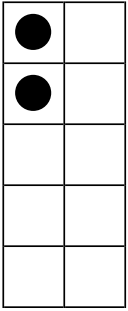
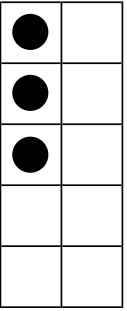
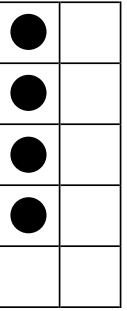
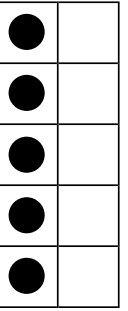
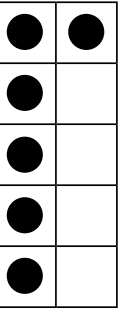
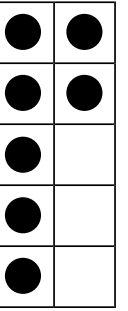
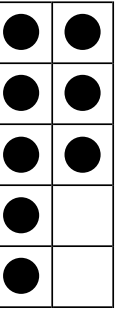
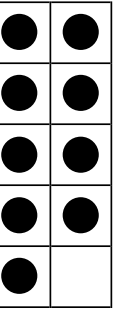
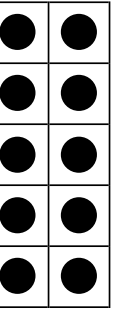
1	2	3	4	5	6	7	8	9	10
un	deux	trois	quatre	cinq	six	sept	huit	neuf	dix
									

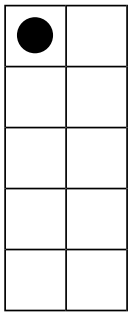
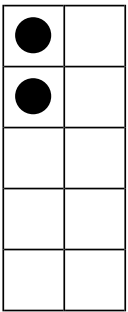
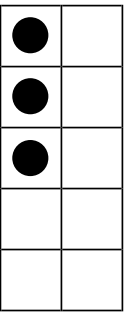
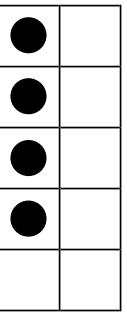
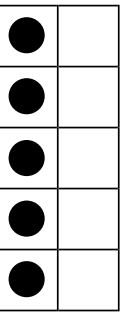
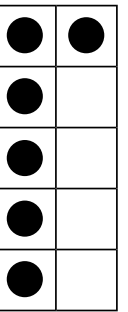
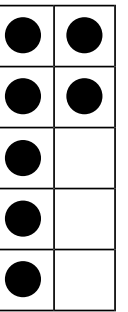
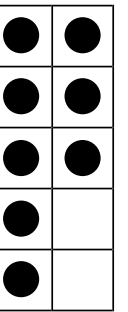
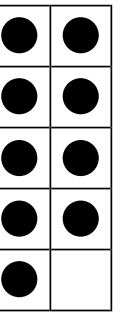
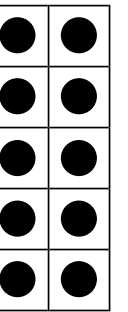

Bande numérique de 1 à 10 représentation imagée et symboliques

1	2	3	4	5	6	7	8	9	10
un	deux	trois	quatre	cinq	six	sept	huit	neuf	dix
									

Nombres en chiffres de 1 à 100

1	2	3	4	5	6	7	8	9	10
11	12	13	14	15	16	17	18	19	20
21	22	23	24	25	26	27	28	29	30
31	32	33	34	35	36	37	38	39	40
41	42	43	44	45	46	47	48	49	50
51	52	53	54	55	56	57	58	59	60
61	62	63	64	65	66	67	68	69	70
71	72	73	74	75	76	77	78	79	80
81	82	83	84	85	86	87	88	89	90
91	92	93	94	95	96	97	98	99	100

Nombres en lettres de 1 à 100

1 un	11 onze	21 vingt et un	31 trente et un	41 quarante et un	51 cinquante et un	61 soixante et un	71 soixante et onze	81 quatre-vingt-un	91 quatre-vingt-onze
2 deux	12 douze	22 vingt-deux	32 trente-deux	42 quarante-deux	52 cinquante-deux	62 soixante-deux	72 soixante-douze	82 quatre-vingt-deux	92 quatre-vingt-douze
3 trois	13 treize	23 vingt-trois	33 trente-trois	43 quarante-trois	53 cinquante-trois	63 soixante-trois	73 soixante-treize	83 quatre-vingt-trois	93 quatre-vingt-treize
4 quatre	14 quatorze	24 vingt-quatre	34 trente-quatre	44 quarante-quatre	54 cinquante-quatre	64 soixante-quatre	74 soixante-quatorze	84 quatre-vingt-quatre	94 quatre-vingt-quatorze
5 cinq	15 quinze	25 vingt-cinq	35 trente-cinq	45 quarante-cinq	55 cinquante-cinq	65 soixante-cinq	75 soixante-quinze	85 quatre-vingt-cinq	95 quatre-vingt-quinze
6 six	16 seize	26 vingt-six	36 trente-six	46 quarante-six	56 cinquante-six	66 soixante-six	76 soixante-seize	86 quatre-vingt-six	96 quatre-vingt-seize
7 sept	17 dix-sept	27 vingt-sept	37 trente-sept	47 quarante-sept	57 cinquante-sept	67 soixante-sept	77 soixante-dix-sept	87 quatre-vingt-sept	97 quatre-vingt-dix-sept
8 huit	18 dix-huit	28 vingt-huit	38 trente-huit	48 quarante-huit	58 cinquante-huit	68 soixante-huit	78 soixante-dix-huit	88 quatre-vingt-huit	98 quatre-vingt-dix-huit
9 neuf	19 dix-neuf	29 vingt-neuf	39 trente-neuf	49 quarante-neuf	59 cinquante-neuf	69 soixante-neuf	79 soixante-dix-neuf	89 quatre-vingt-neuf	99 quatre-vingt-dix-neuf
10 dix	20 vingt	30 trente	40 quarante	50 cinquante	60 soixante	70 soixante-dix	80 quatre-vingts	90 quatre-vingt-dix	100 cent

Cercles fractionnaires

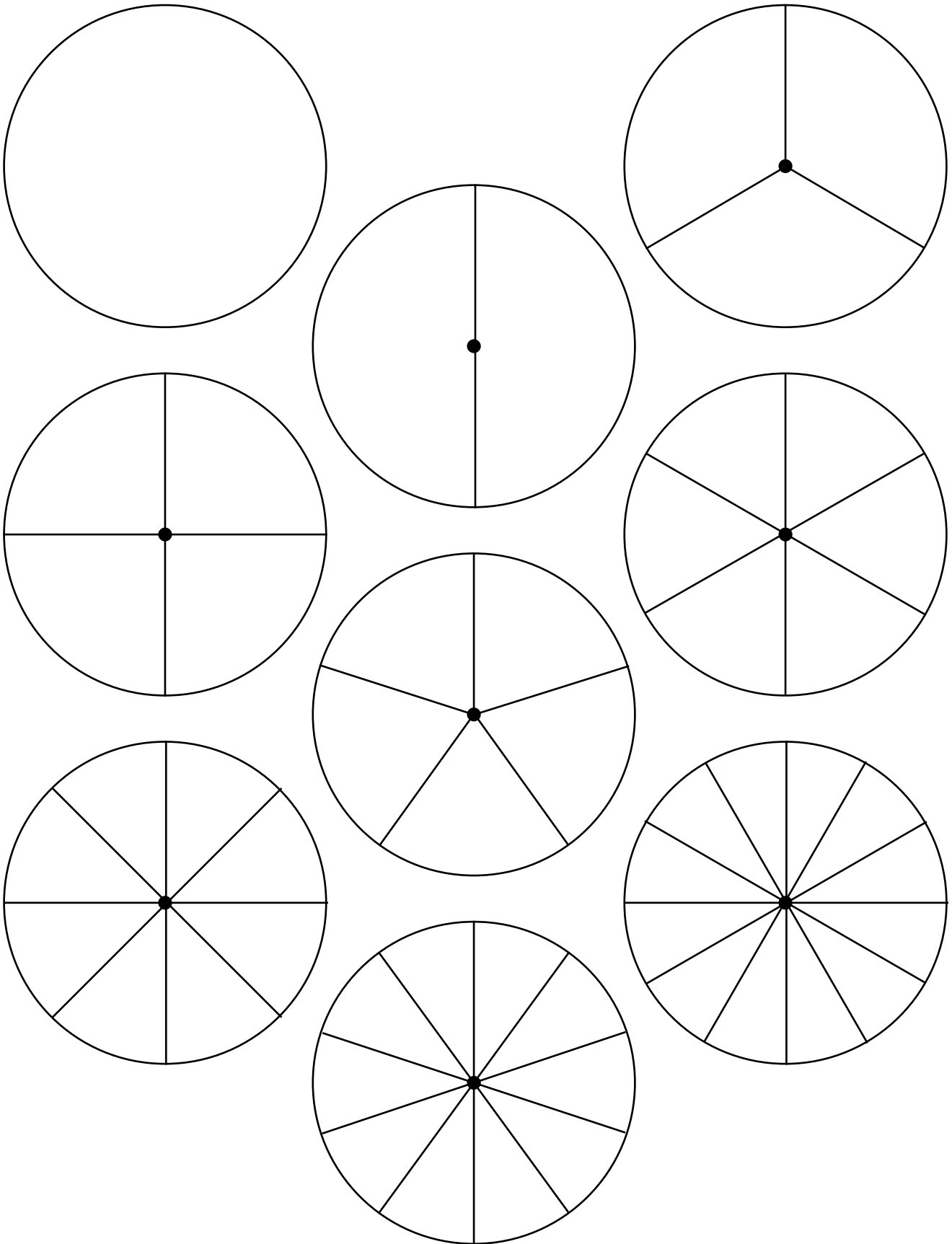

Les roulettes - Chiffres
Divisée en sixièmes (1 à 6)

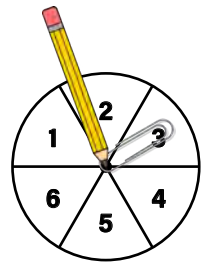
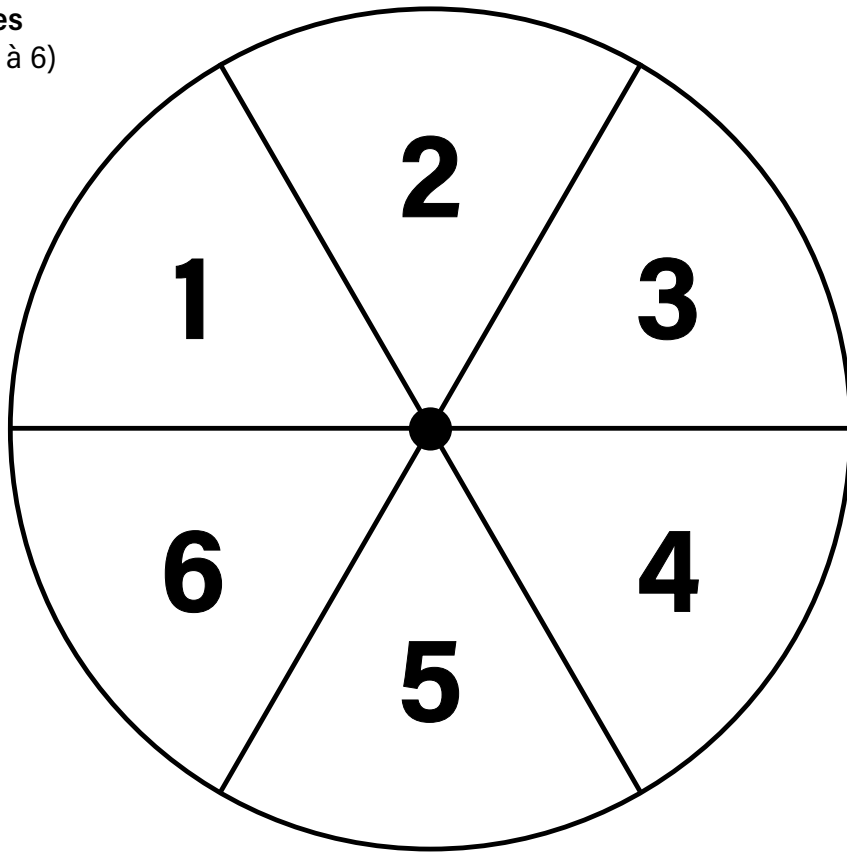

Les roulettes - Chiffres
Divisée en sixièmes (1 à 6)

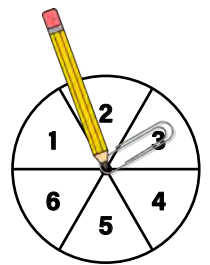
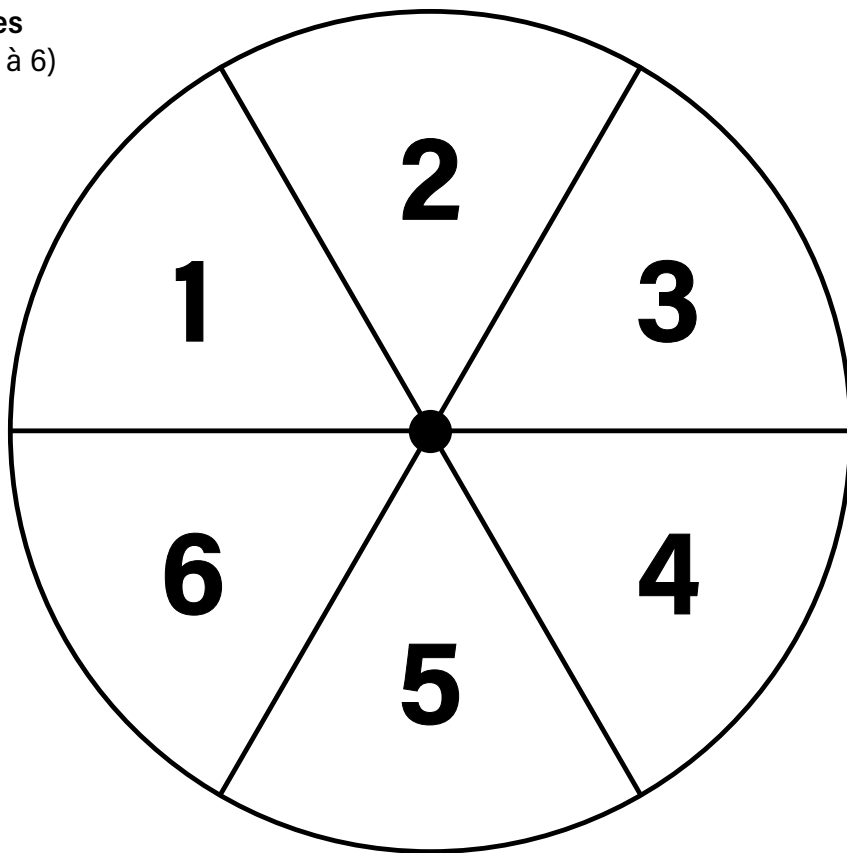

Les roulettes - Chiffres
Divisée en huitièmes (1 à 8)

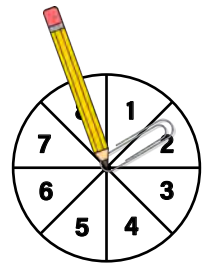
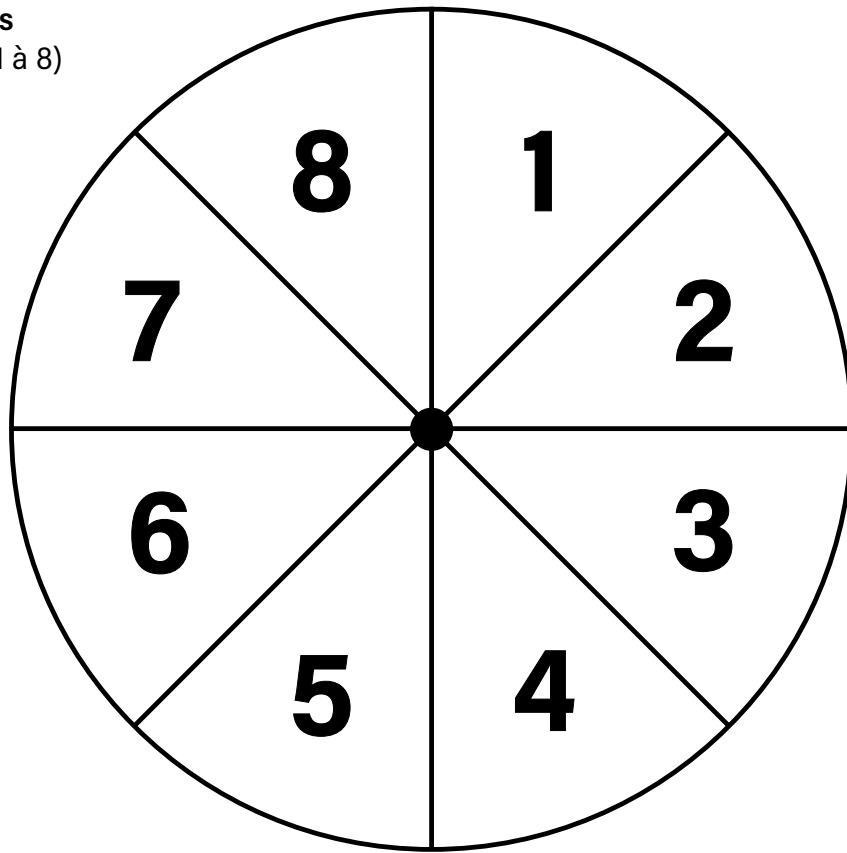

Les roulettes - Chiffres
Divisée en huitièmes (1 à 8)

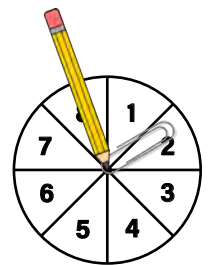
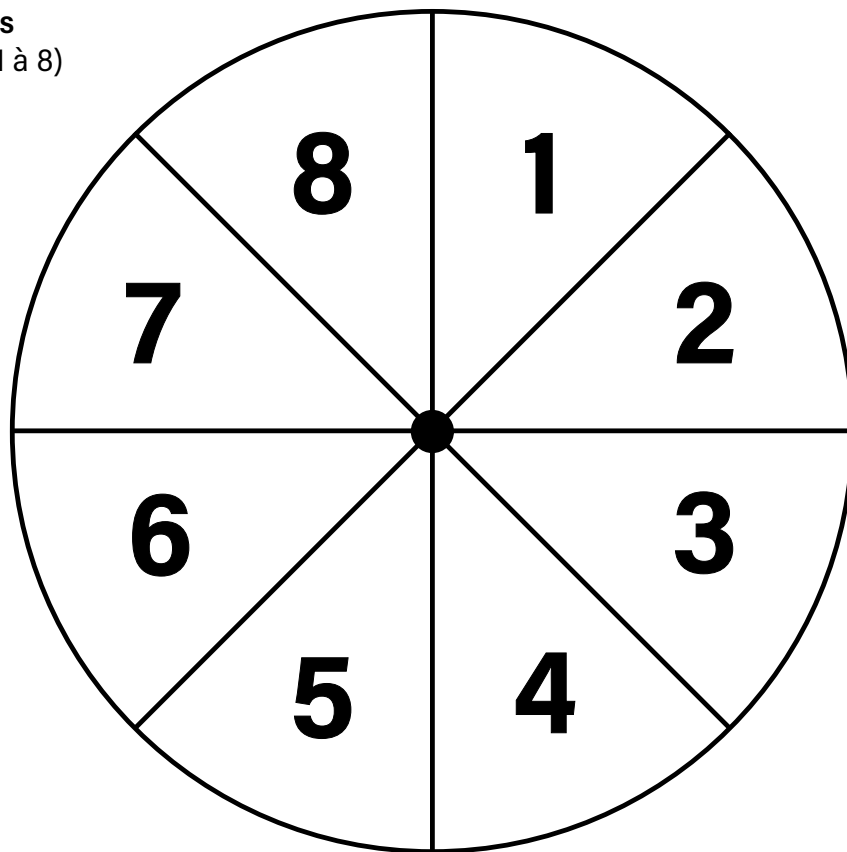

Les roulettes - Chiffres
Divisée en dix (0 à 9)

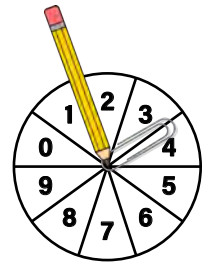
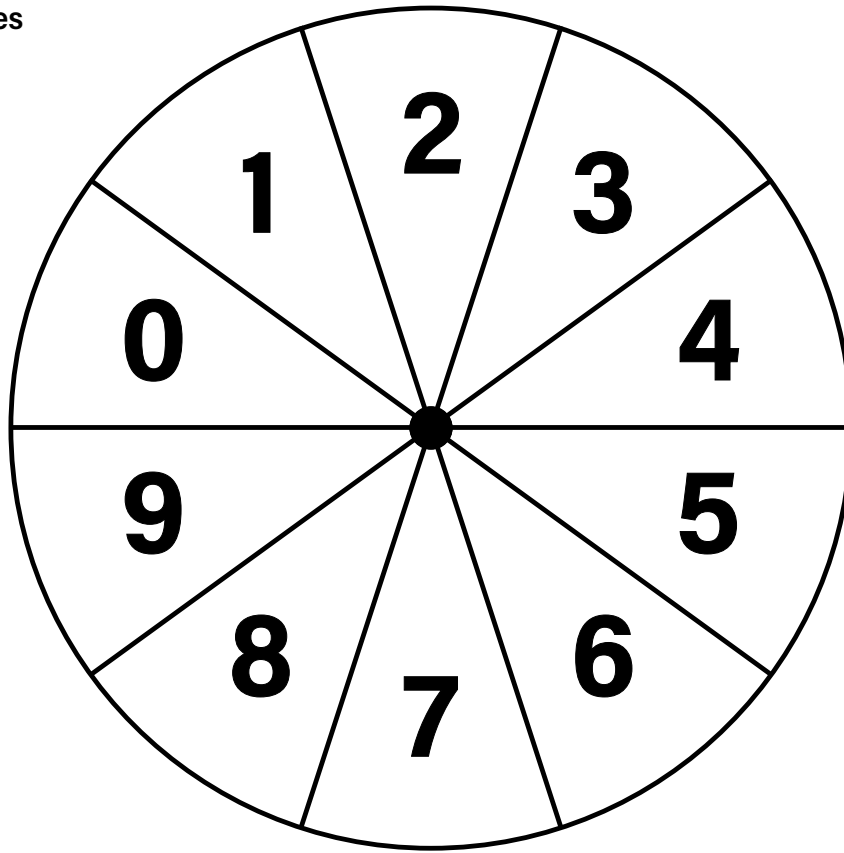

Les roulettes - Chiffres
Divisée en dix (0 à 9)

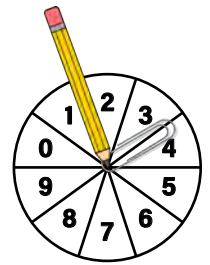
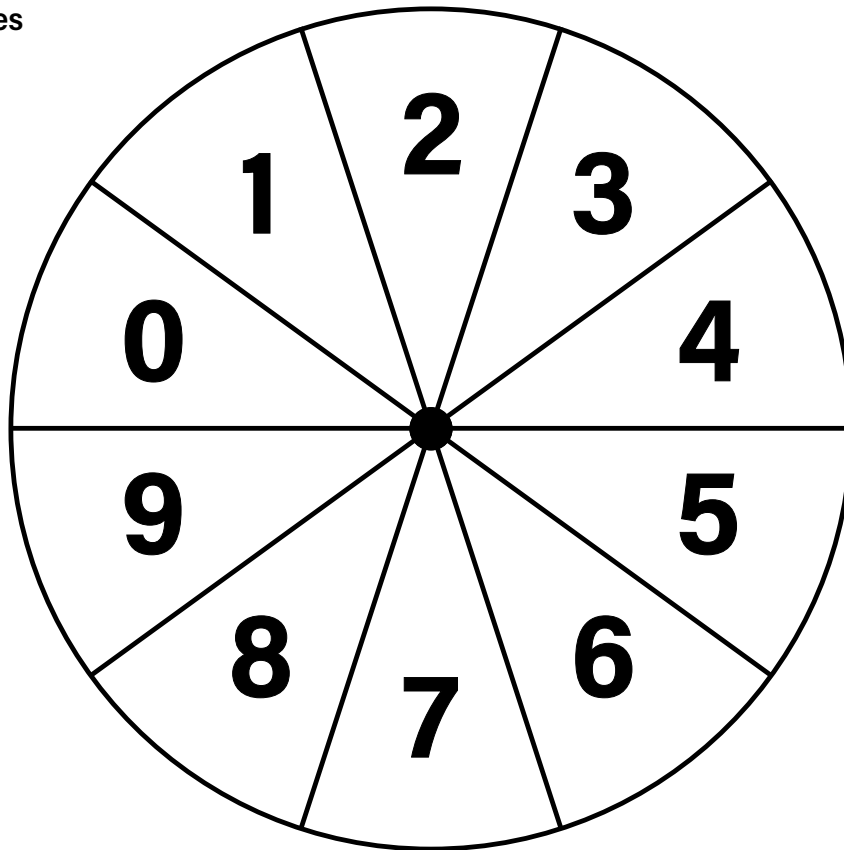

Les roulettes - Chiffres
Divisée en dixièmes (1 à 10)

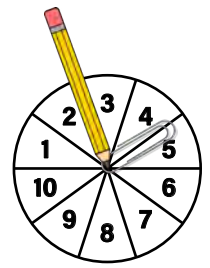
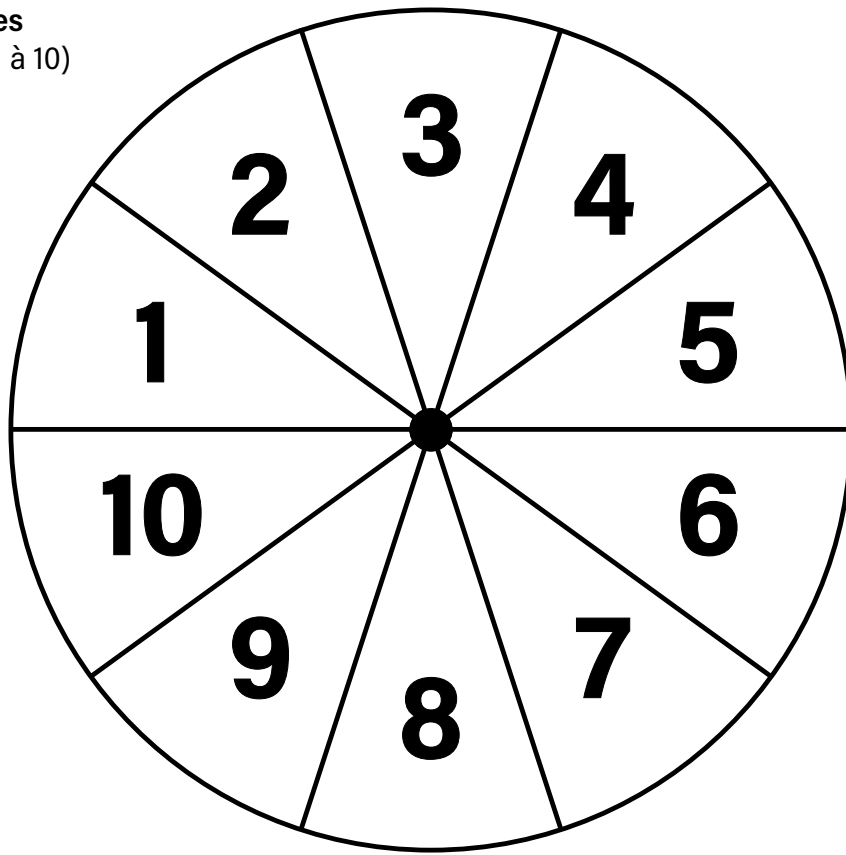

Les roulettes - Chiffres
Divisée en dixièmes (1 à 10)

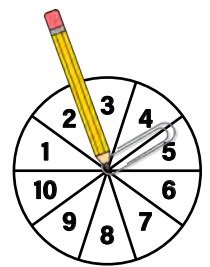
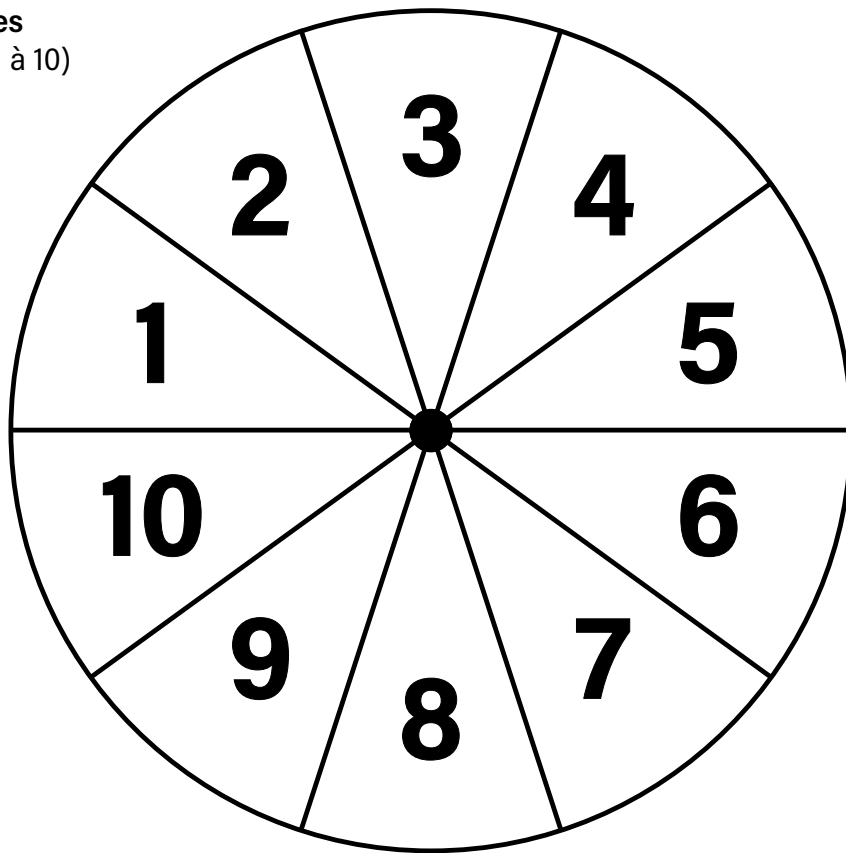

Les roulettes
Cartes à points

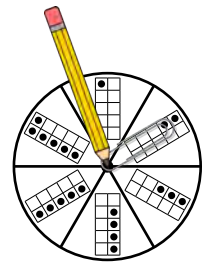
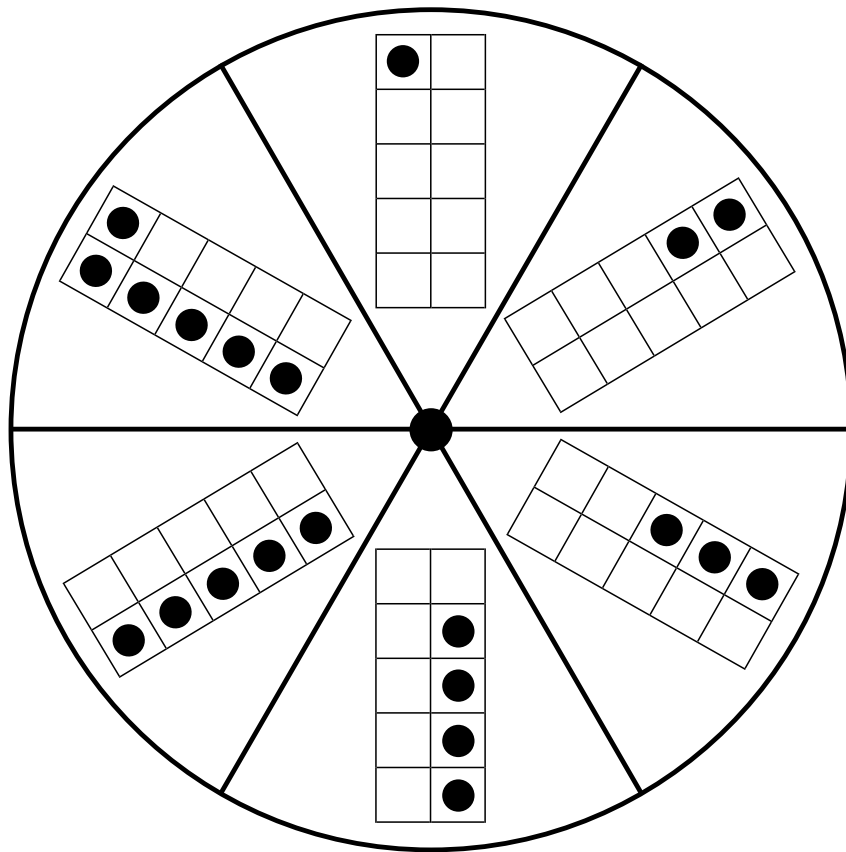

Les roulettes
Cartes à points

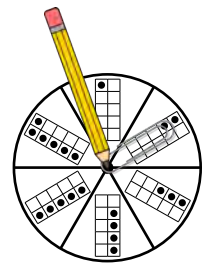
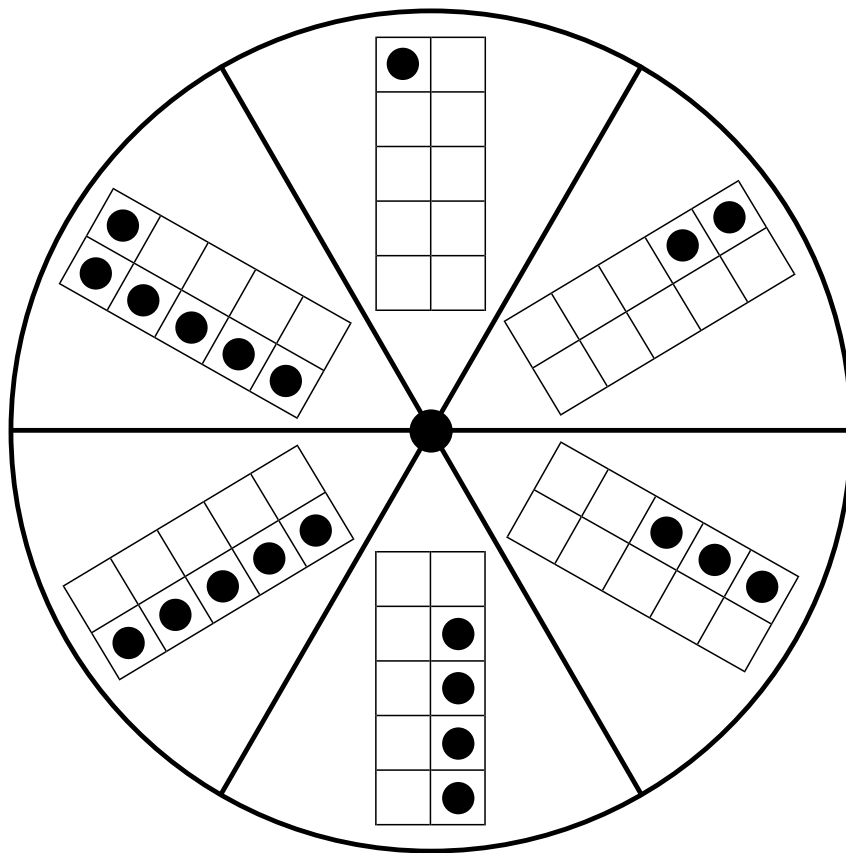

Les roulettes

Symboles d'opérations

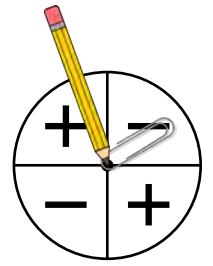
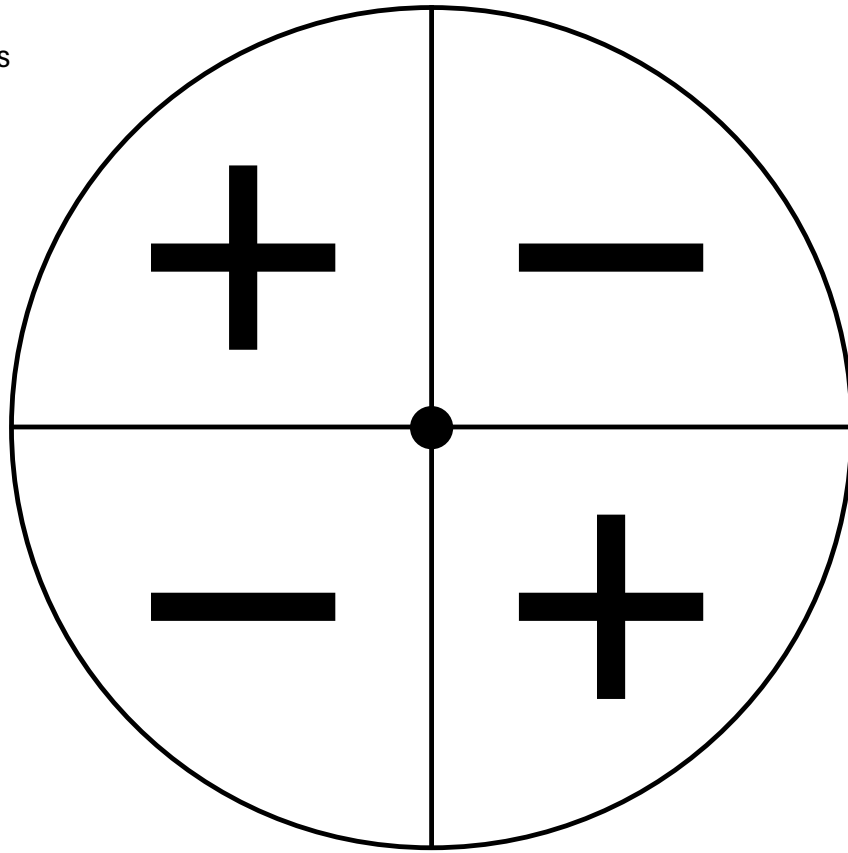

Les roulettes

Symboles d'opérations

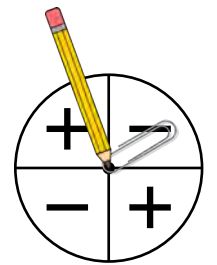
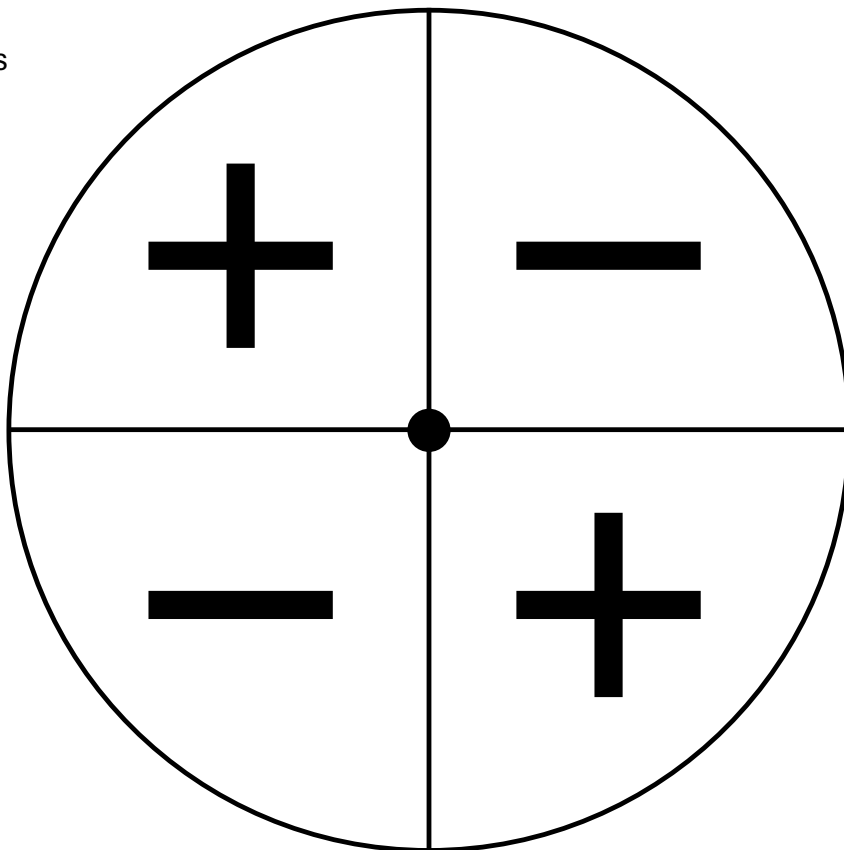

Les roulettes

Symboles d'opérations

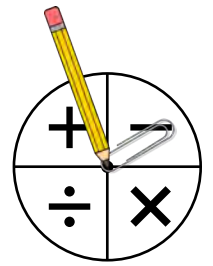
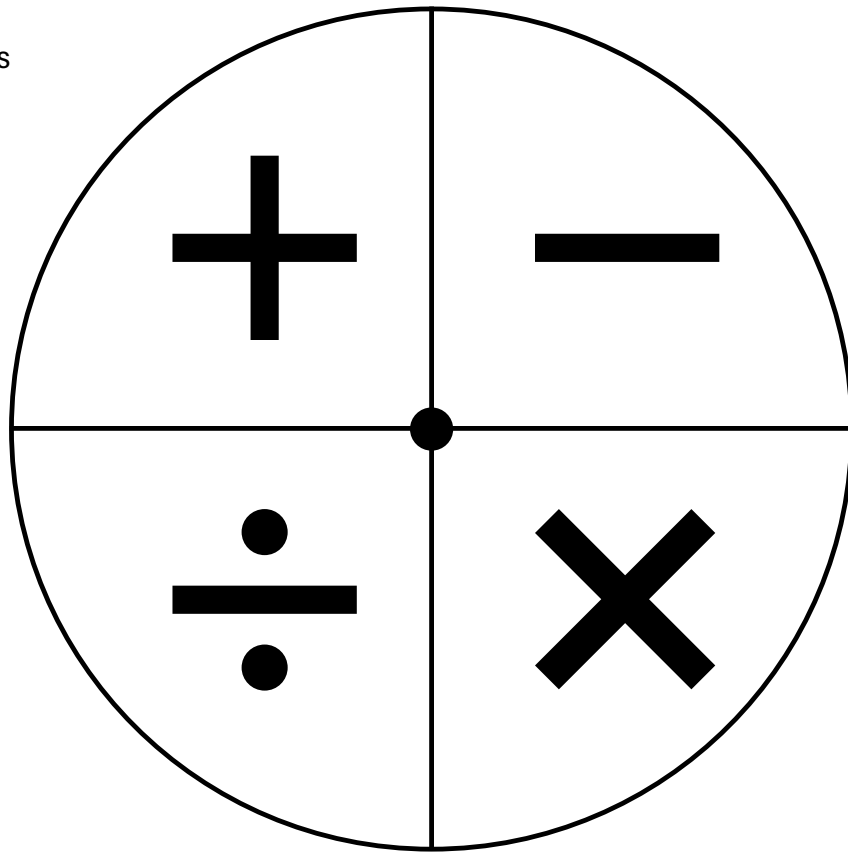

Les roulettes

Symboles d'opérations

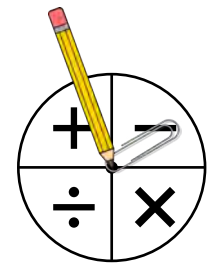
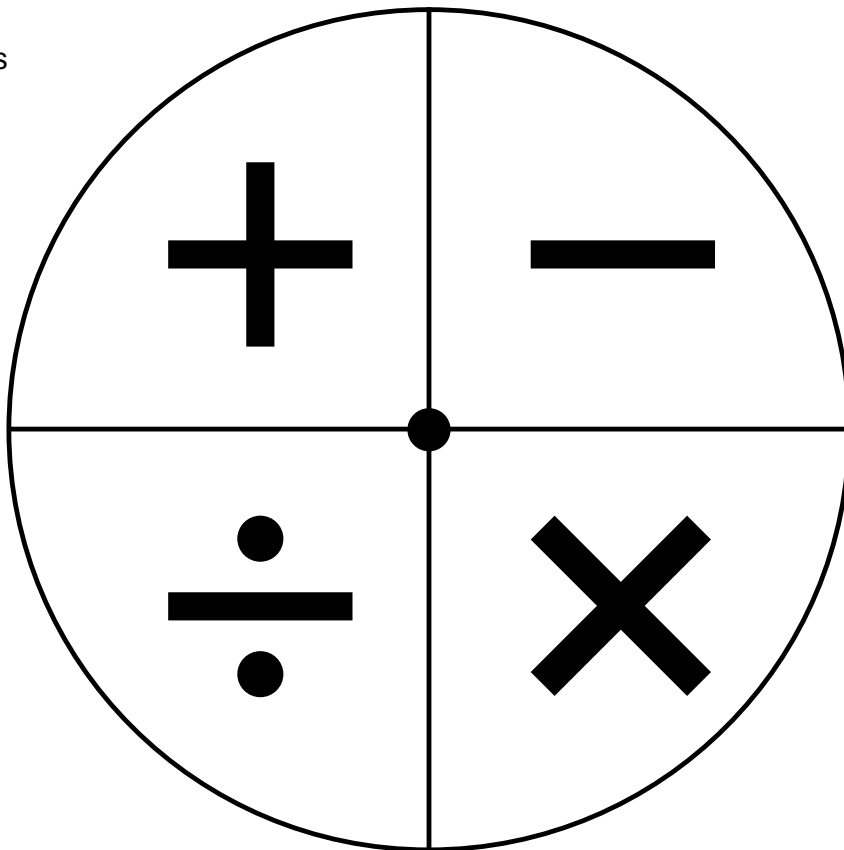

Les roulettes

Divisée en quarts (un de plus,
un de moins, deux de plus,
deux de moins)

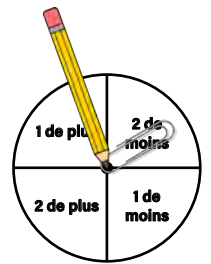
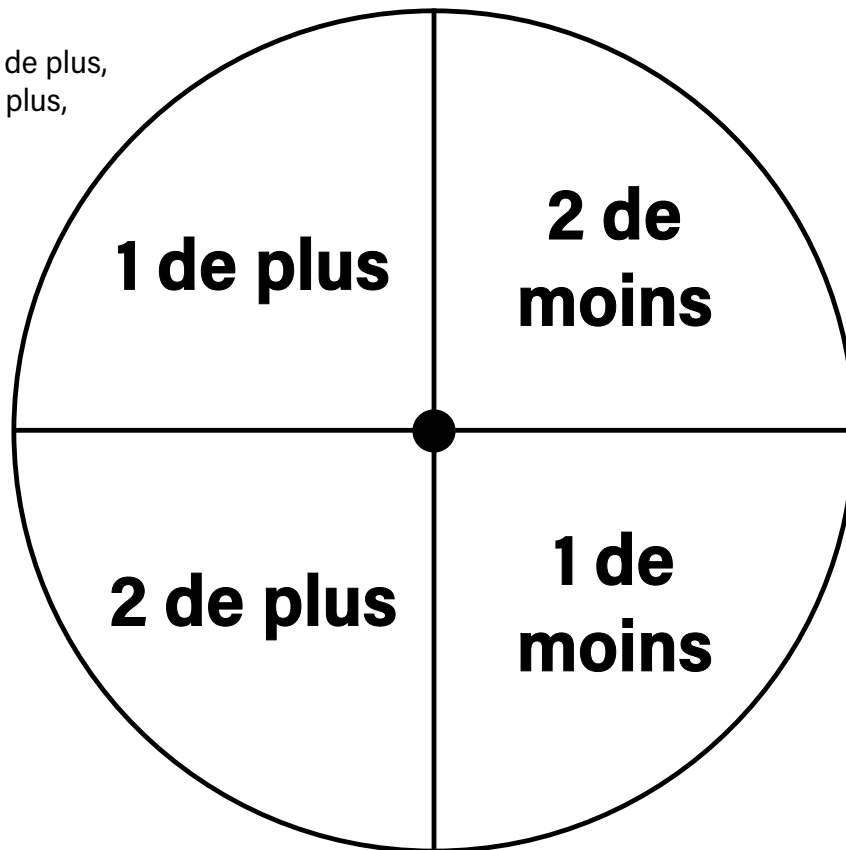
**Les roulettes**

Divisée en quarts (un de plus,
un de moins, deux de plus,
deux de moins)

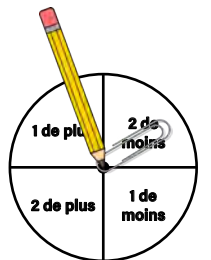
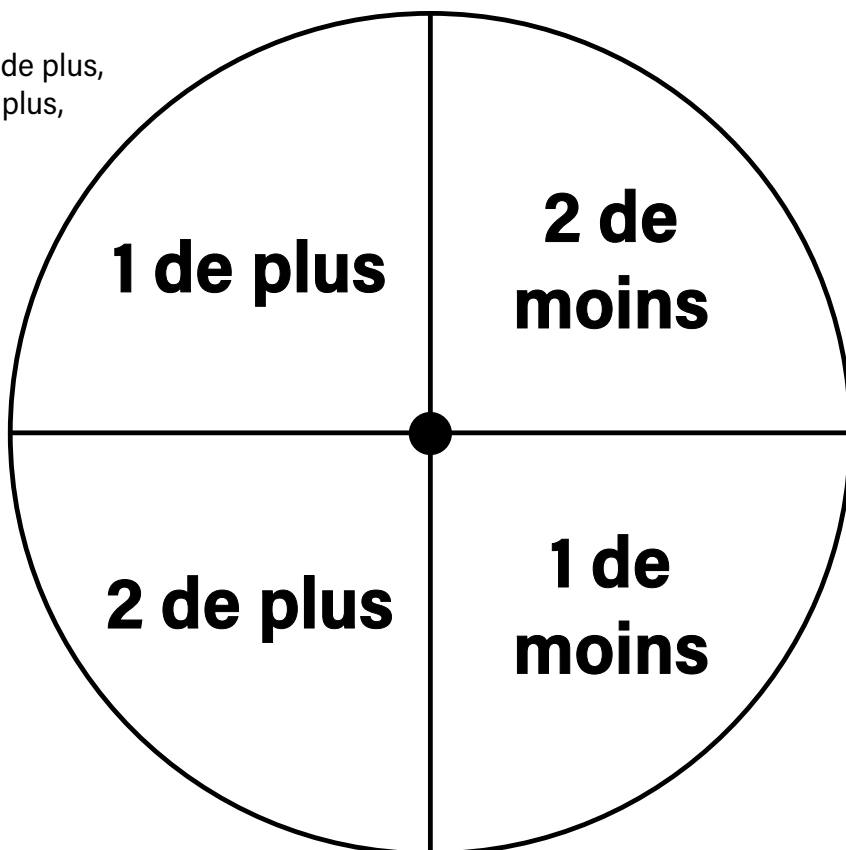

Les roulettes

Divisée en quarts (vides)

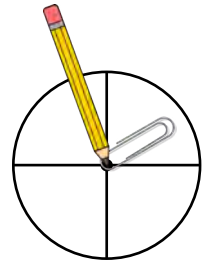
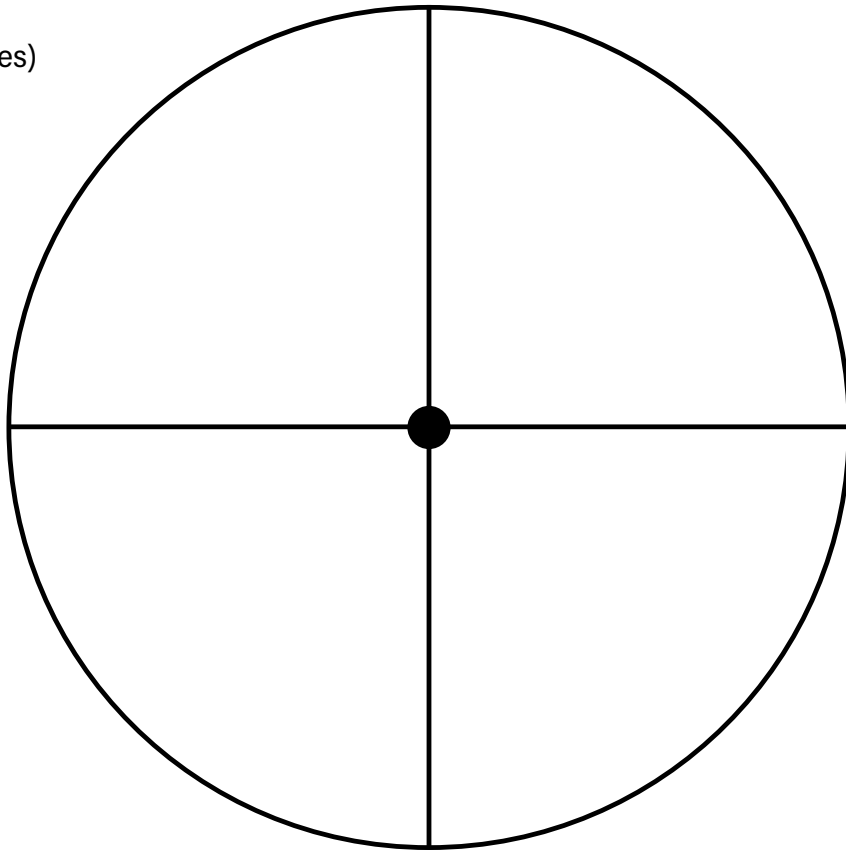

Les roulettes

Divisée en quarts (vides)

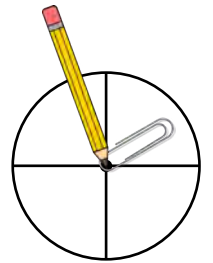
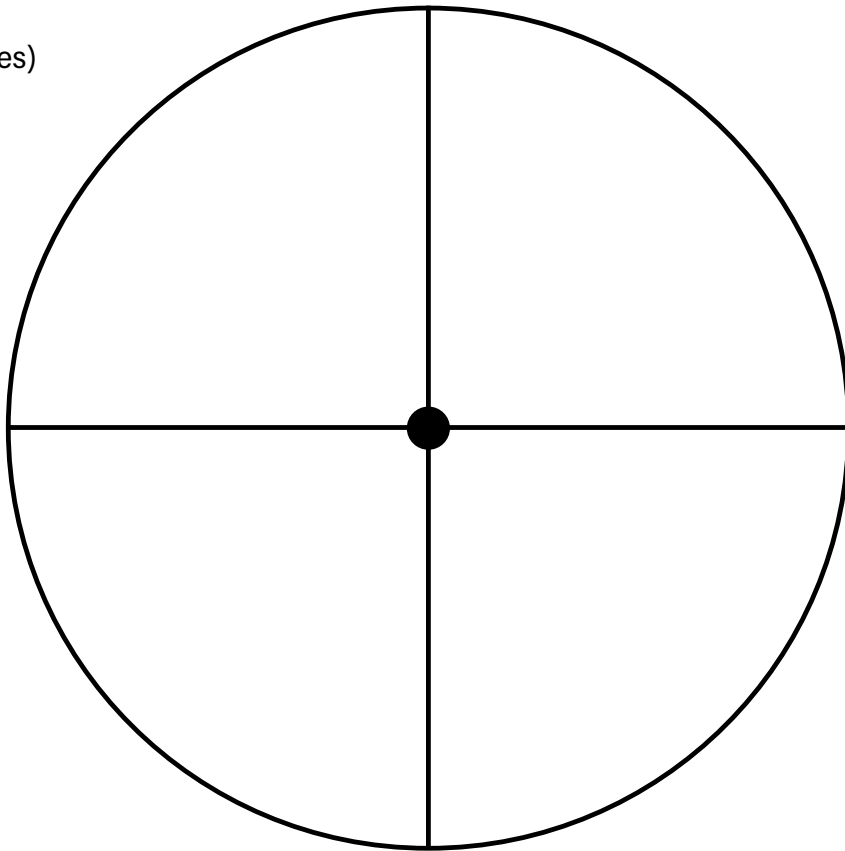

Les roulettes

Divisée en sixièmes (vides)

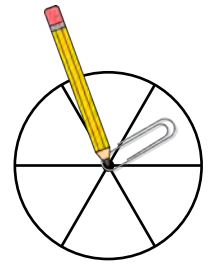
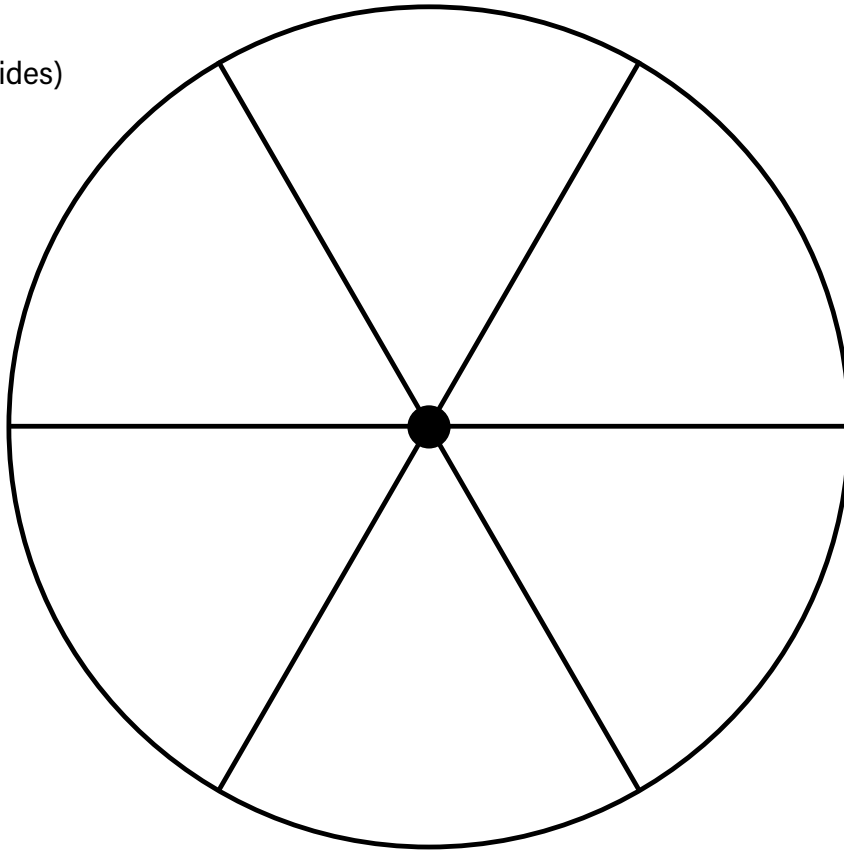

Les roulettes

Divisée en sixièmes (vides)

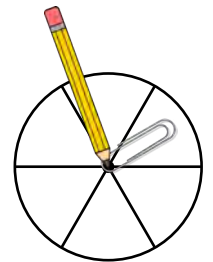
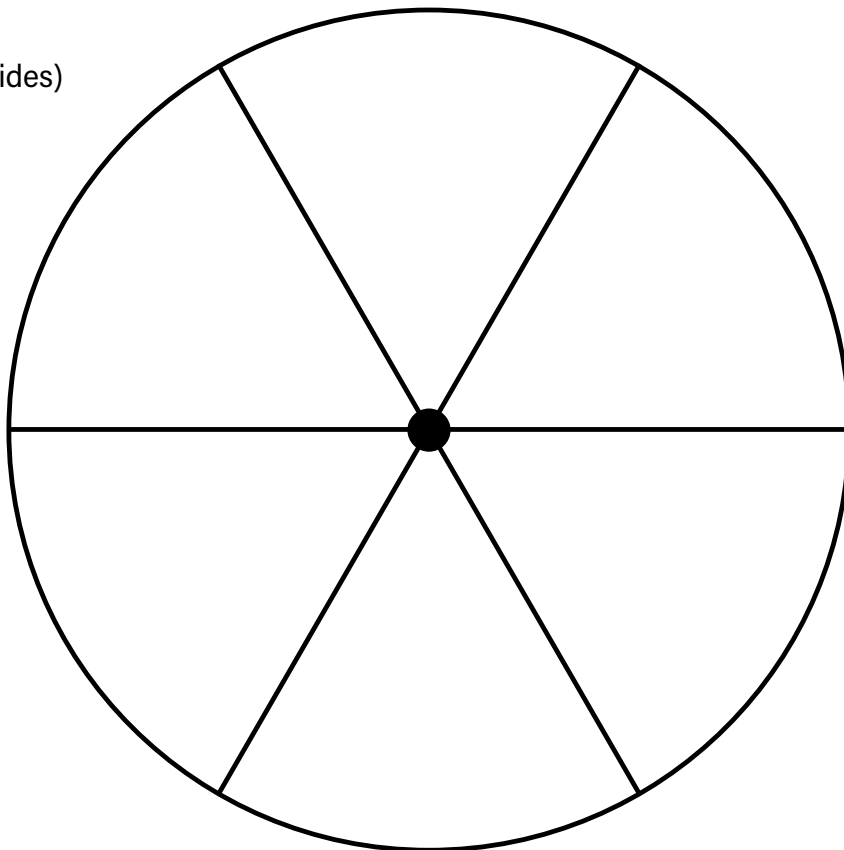

Les roulettes

Divisée en huitièmes (vides)

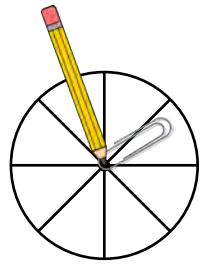
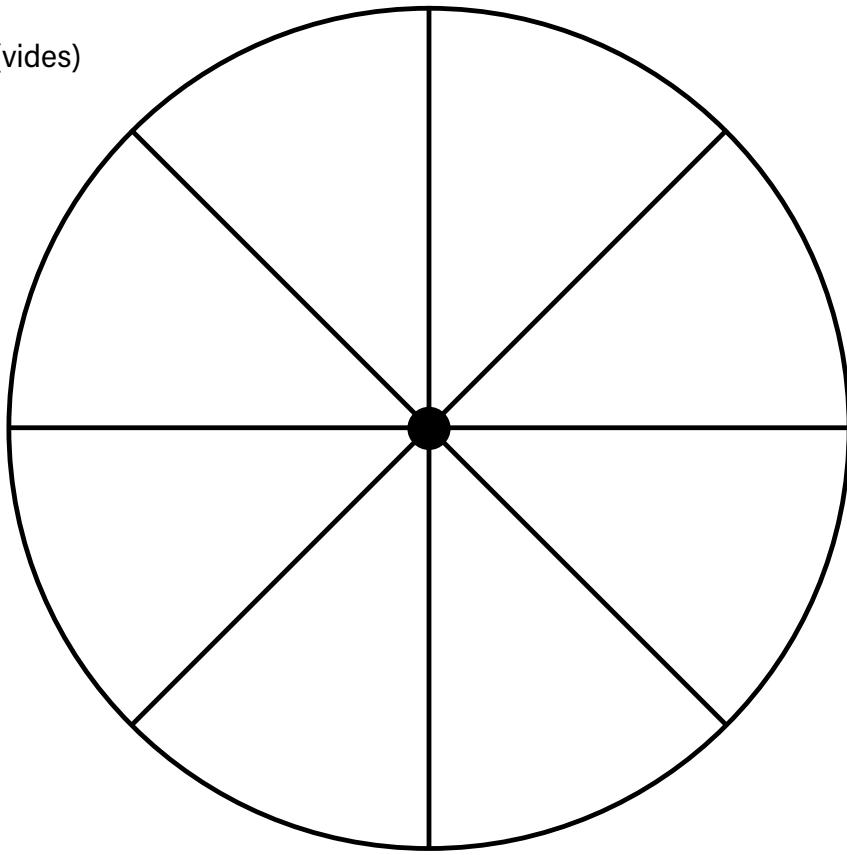

Les roulettes

Divisée en huitièmes (vides)

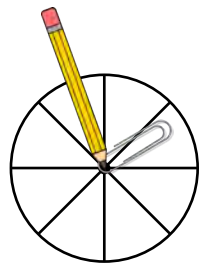
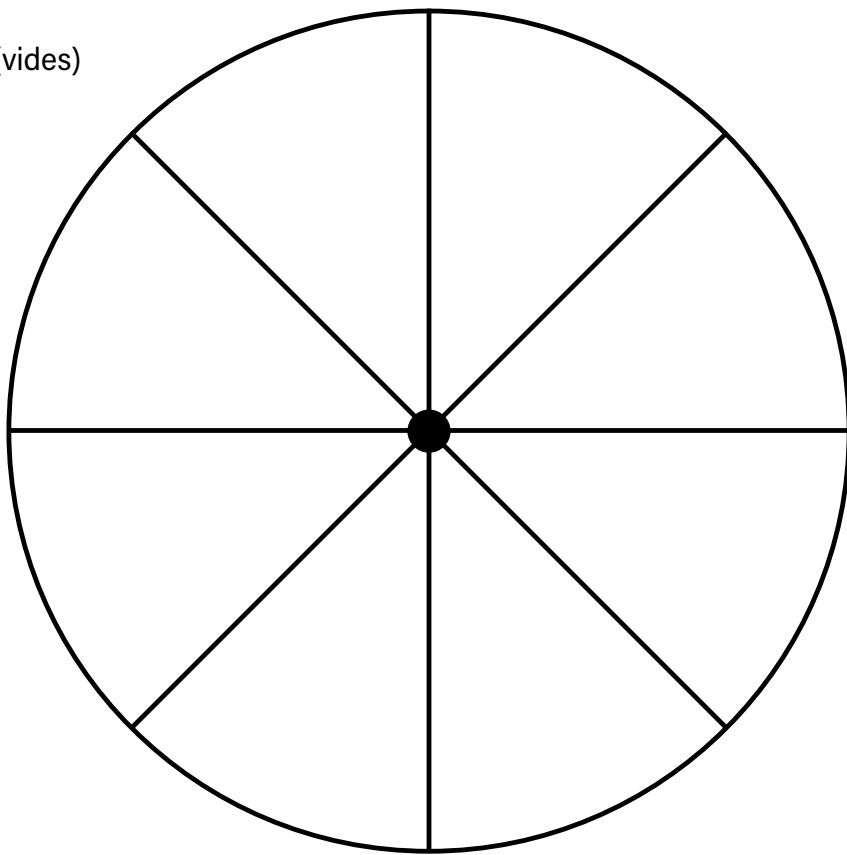

Les roulettes

Divisée en dixièmes (vides)

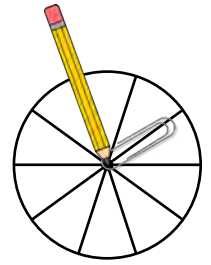
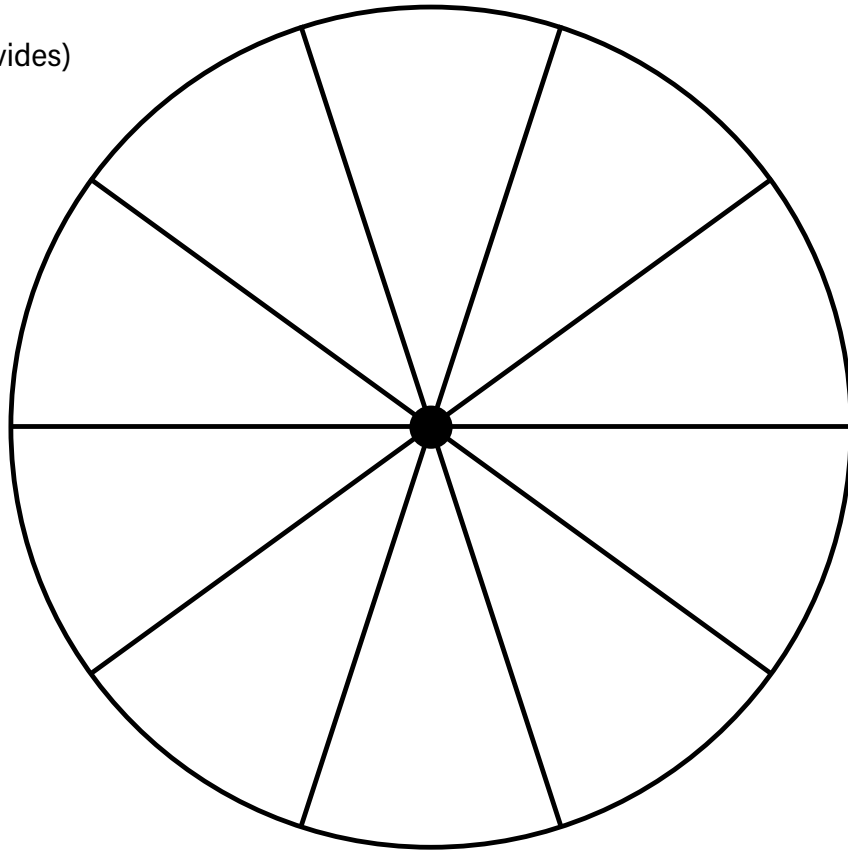

Les roulettes

Divisée en dixièmes (vides)

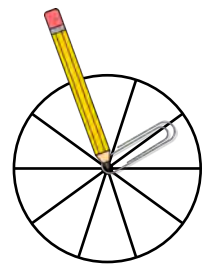
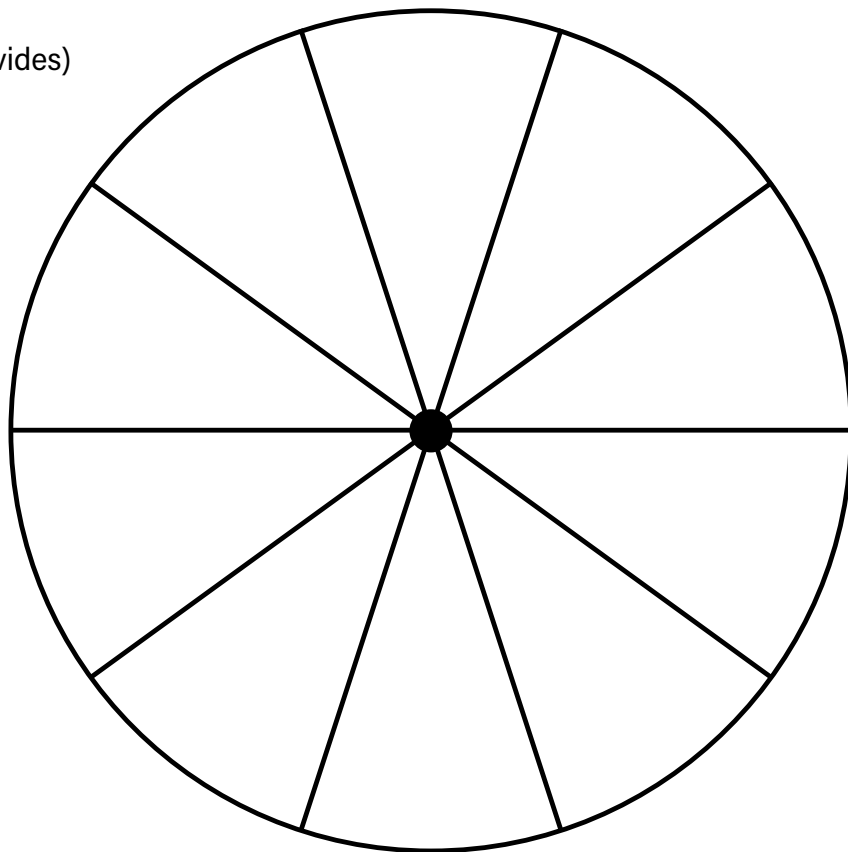



+1
1 de plus que

MON NOMBRE EST



Constellation

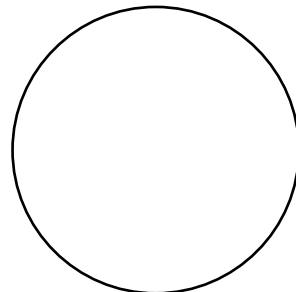

Carte à 5 points

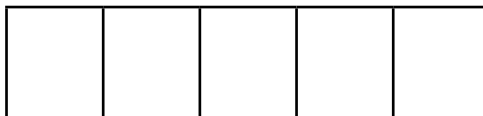
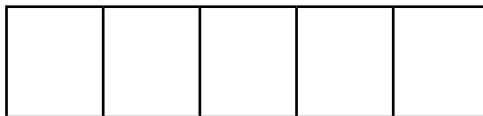

-1
1 de moins que



Cordes à 10 billes

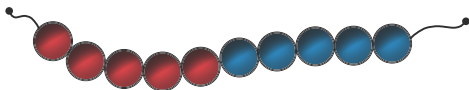

**Place ou dessine
la quantité d'objets
qui correspond à
ton nombre.**



+2
2 de plus que

-2
2 de moins que



MON NOMBRE EST

La droite numérique

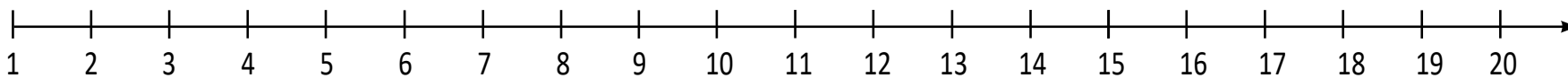

Écris-le en mot **a, b, c...**

.....



Comptes à rebours à partir de _____

.....
.....
.....
.....
.....

Avec une corde à billes :



Avec une corde à billes :

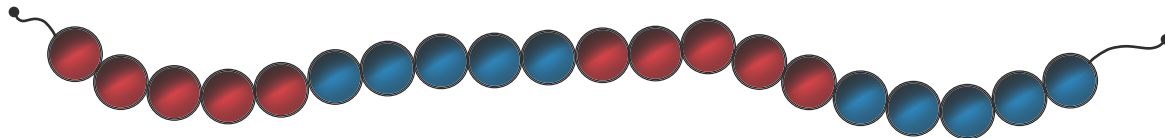

Avec des marques de fréquences (III)

Avec des cubes emboîtables :

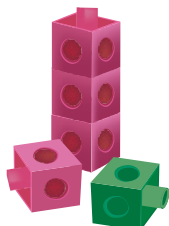

Avec la représentation de mon choix

Pour faire 20...

$$\boxed{} + \underline{} = 20$$

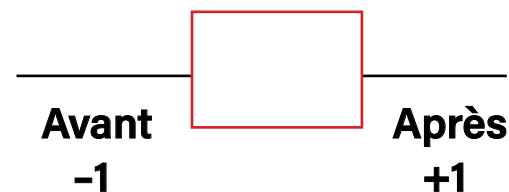

Avec quatre additions :

Avec deux soustractions :

Avant **Après**

-19 **+19**

Avec des marques de fréquences (H#)

Représentation de mon nombre à l'aide de blocs de base 10



MON NOMBRE EST



Encerle ton nombre

1	2	3	4	5	6	7	8	9	10
11	12	13	14	15	16	17	18	19	20
21	22	23	24	25	26	27	28	29	30
31	32	33	34	35	36	37	38	39	40
41	42	43	44	45	46	47	48	49	50
51	52	53	54	55	56	57	58	59	60
61	62	63	64	65	66	67	68	69	70
71	72	73	74	75	76	77	78	79	80
81	82	83	84	85	86	87	88	89	90
91	92	93	94	95	96	97	98	99	100

C'est un nombre pair ou impair

Avec une corde à billes :

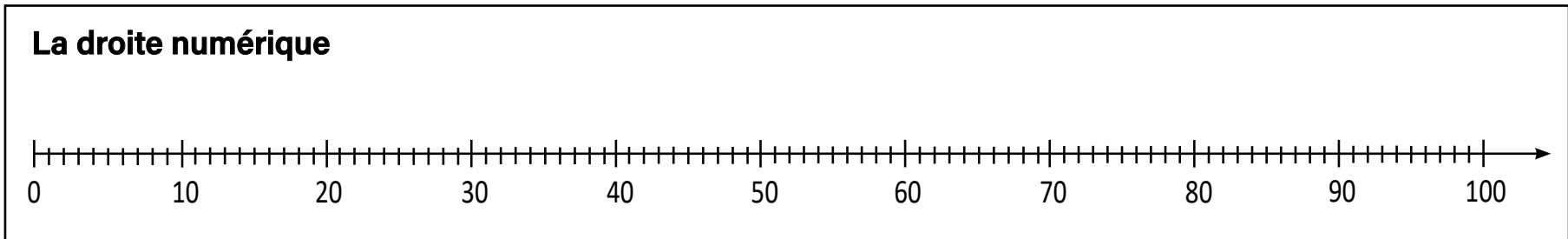

La droite numérique

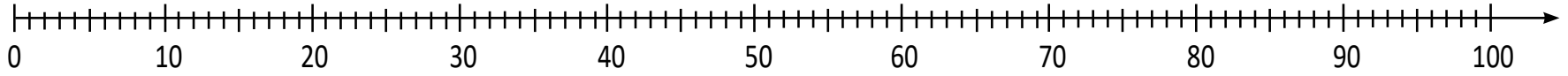

Avec des blocs de base 10 :

_____ dizaines et _____ unités



Pour faire 100...

$$\boxed{} + \underline{} = 100$$

Pour faire 100...

$$\boxed{} + \underline{} = 100$$

Avec des cartes à points :



Sur un morceau de tableau de 100 :

Pour faire 100...

+ _____ = 100

Écris-le en mot a, b, c...

.....

.....

.....

.....

.....

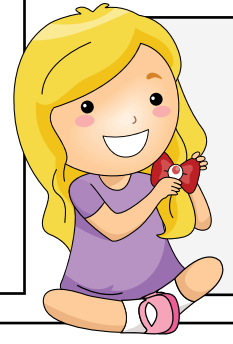

MON NOMBRE EST

Dans une addition avec la droite numérique :

+ 37 = _____

Avec trois additions :

Avec deux soustractions :

Avec des blocs de base 10 :



J'ajoute 1 dizaine à mon nombre.

J'ajoute 6 unités à mon nombre.

J'ajoute 3 centaines à mon nombre.

C'est un nombre pair ou impair.

Je le représente à l'aide de blocs 10.

- **+**

Centaine	Dizaine	Unité
<input type="text"/>	<input type="text"/>	<input type="text"/>

Il y a _____ centaine dans mon nombre,
Il y a _____ dizaines dans mon nombre.
Il y a _____ unités dans mon nombre.

Écris-le en mot a, b, c...

MON NOMBRE EST _____

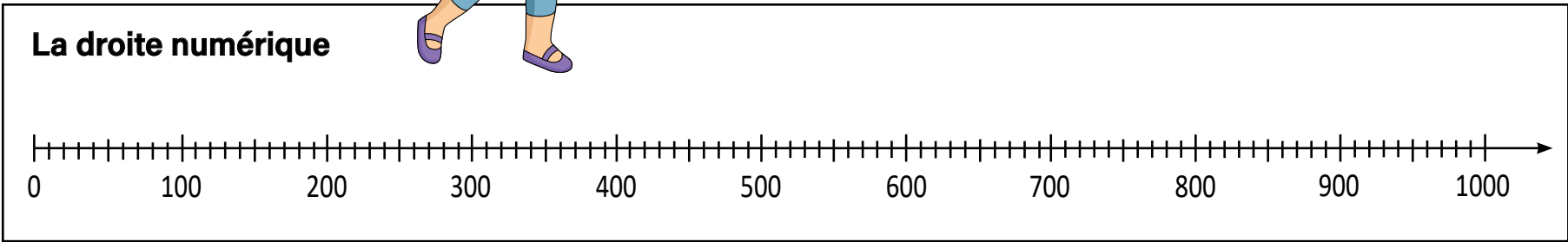

Je fais des bons de _____ à partir de mon nombre

<input type="text"/>	<input type="text"/>	<input type="text"/>	<input type="text"/>	<input type="text"/>	<input type="text"/>	<input type="text"/>	<input type="text"/>	<input type="text"/>
----------------------	----------------------	----------------------	----------------------	----------------------	----------------------	----------------------	----------------------	----------------------

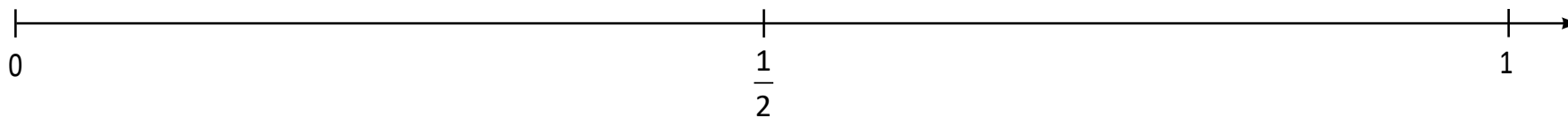
Je situe ma fraction sur la droite numérique

Ma fraction est plus près de _____ que de _____.

Selon un modèle de longueur à l'aide de réglettes.

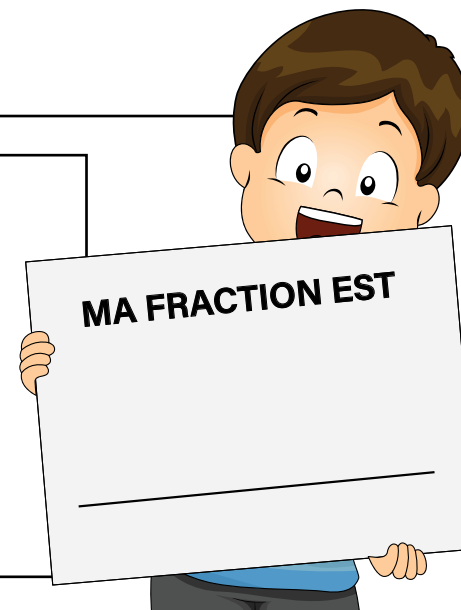

Selon un modèle d'aire à l'aide de blocs mosaïques.

Selon un modèle d'ensemble à l'aide des objets de mon choix.

Tableaux de nombres (1 à 20)

1	2	3	4	5	6	7	8	9	10
11	12	13	14	15	16	17	18	19	20



1	2	3	4	5	6	7	8	9	10
11	12	13	14	15	16	17	18	19	20



1	2	3	4	5	6	7	8	9	10
11	12	13	14	15	16	17	18	19	20



Tableaux de nombres (1 à 30)

1	2	3	4	5	6	7	8	9	10
11	12	13	14	15	16	17	18	19	20
21	22	23	24	25	26	27	28	29	30



1	2	3	4	5	6	7	8	9	10
11	12	13	14	15	16	17	18	19	20
21	22	23	24	25	26	27	28	29	30



1	2	3	4	5	6	7	8	9	10
11	12	13	14	15	16	17	18	19	20
21	22	23	24	25	26	27	28	29	30



Tableaux de nombres (1 à 100)

1	2	3	4	5	6	7	8	9	10
11	12	13	14	15	16	17	18	19	20
21	22	23	24	25	26	27	28	29	30
31	32	33	34	35	36	37	38	39	40
41	42	43	44	45	46	47	48	49	50
51	52	53	54	55	56	57	58	59	60
61	62	63	64	65	66	67	68	69	70
71	72	73	74	75	76	77	78	79	80
81	82	83	84	85	86	87	88	89	90
91	92	93	94	95	96	97	98	99	100

Tableaux de nombres (0 à 99)

0	1	2	3	4	5	6	7	8	9
10	11	12	13	14	15	16	17	18	19
20	21	22	23	24	25	26	27	28	29
30	31	32	33	34	35	36	37	38	39
40	41	42	43	44	45	46	47	48	49
50	51	52	53	54	55	56	57	58	59
60	61	62	63	64	65	66	67	68	69
70	71	72	73	74	75	76	77	78	79
80	81	82	83	84	85	86	87	88	89
90	91	92	93	94	95	96	97	98	99

Tableaux de nombres (100 vide)

1	2	3	4	5	6	7	8	9	10
11	12	13	14	15	16	17	18	19	20
21	22	23	24	25	26	27	28	29	30
31	32	33	34	35	36	37	38	39	40
41	42	43	44	45	46	47	48	49	50
51	52	53	54	55	56	57	58	59	60
61	62	63	64	65	66	67	68	69	70
71	72	73	74	75	76	77	78	79	80
81	82	83	84	85	86	87	88	89	90
91	92	93	94	95	96	97	98	99	100

1	2	3	4	5	6	7	8	9	10
11	12	13	14	15	16	17	18	19	20
21	22	23	24	25	26	27	28	29	30
31	32	33	34	35	36	37	38	39	40
41	42	43	44	45	46	47	48	49	50
51	52	53	54	55	56	57	58	59	60
61	62	63	64	65	66	67	68	69	70
71	72	73	74	75	76	77	78	79	80
81	82	83	84	85	86	87	88	89	90
91	92	93	94	95	96	97	98	99	100

1	2	3	4	5	6	7	8	9	10
11	12	13	14	15	16	17	18	19	20
21	22	23	24	25	26	27	28	29	30
31	32	33	34	35	36	37	38	39	40
41	42	43	44	45	46	47	48	49	50
51	52	53	54	55	56	57	58	59	60
61	62	63	64	65	66	67	68	69	70
71	72	73	74	75	76	77	78	79	80
81	82	83	84	85	86	87	88	89	90
91	92	93	94	95	96	97	98	99	100

1	2	3	4	5	6	7	8	9	10
11	12	13	14	15	16	17	18	19	20
21	22	23	24	25	26	27	28	29	30
31	32	33	34	35	36	37	38	39	40
41	42	43	44	45	46	47	48	49	50
51	52	53	54	55	56	57	58	59	60
61	62	63	64	65	66	67	68	69	70
71	72	73	74	75	76	77	78	79	80
81	82	83	84	85	86	87	88	89	90
91	92	93	94	95	96	97	98	99	100

Tableaux de nombres (1 à 120)

1	2	3	4	5	6	7	8	9	10
11	12	13	14	15	16	17	18	19	20
21	22	23	24	25	26	27	28	29	30
31	32	33	34	35	36	37	38	39	40
41	42	43	44	45	46	47	48	49	50
51	52	53	54	55	56	57	58	59	60
61	62	63	64	65	66	67	68	69	70
71	72	73	74	75	76	77	78	79	80
81	82	83	84	85	86	87	88	89	90
91	92	93	94	95	96	97	98	99	100
101	102	103	104	105	106	107	108	109	110
111	112	113	114	115	116	117	118	119	120



Tableaux de nombres (1 à 200)

1	2	3	4	5	6	7	8	9	10
11	12	13	14	15	16	17	18	19	20
21	22	23	24	25	26	27	28	29	30
31	32	33	34	35	36	37	38	39	40
41	42	43	44	45	46	47	48	49	50
51	52	53	54	55	56	57	58	59	60
61	62	63	64	65	66	67	68	69	70
71	72	73	74	75	76	77	78	79	80
81	82	83	84	85	86	87	88	89	90
91	92	93	94	95	96	97	98	99	100
101	102	103	104	105	106	107	108	109	110
111	112	113	114	115	116	117	118	119	120
121	122	123	124	125	126	127	128	129	130
131	132	133	134	135	136	137	138	139	140
141	142	143	144	145	146	147	148	149	150
151	152	153	154	155	156	157	158	159	160
161	162	163	164	165	166	167	168	169	170
171	172	173	174	175	176	177	178	179	180
181	182	183	184	185	186	187	188	189	190
191	192	193	194	195	196	197	198	199	200



Tableaux de nombres

(1 à 100 - du bas vers le haut)

91	92	93	94	95	96	97	98	99	100
81	82	83	84	85	86	87	88	89	90
71	72	73	74	75	76	77	78	79	80
61	62	63	64	65	66	67	68	69	70
51	52	53	54	55	56	57	58	59	60
41	42	43	44	45	46	47	48	49	50
31	32	33	34	35	36	37	38	39	40
21	22	23	24	25	26	27	28	29	30
11	12	13	14	15	16	17	18	19	20
1	2	3	4	5	6	7	8	9	10



Tableaux de nombres (1 à 200 - du bas vers le haut)

200	199	198	197	196	195	194	193	192	191
190	189	188	187	186	185	184	183	182	181
180	179	178	177	176	175	174	173	172	171
170	169	168	167	166	165	164	163	162	161
160	159	158	157	156	155	154	153	152	151
150	149	148	147	146	145	144	143	142	141
140	139	138	137	136	135	134	133	132	131
130	129	128	127	126	125	124	123	122	121
120	119	118	117	116	115	114	113	112	111
110	109	108	107	106	105	104	103	102	101
100	99	98	97	96	95	94	93	92	91
90	89	88	87	86	85	84	83	82	81
80	79	78	77	76	75	74	73	72	71
70	69	68	67	66	65	64	63	62	61
60	59	58	57	56	55	54	53	52	51
50	49	48	47	46	45	44	43	42	41
40	39	38	37	36	35	34	33	32	31
30	29	28	27	26	25	24	23	22	21
20	19	18	17	16	15	14	13	12	11
10	9	8	7	6	5	4	3	2	1



Tableaux de nombres (1 à 200 - du bas vers le haut)

200	199	198	197	196	195	194	193	192	191
190	189	188	187	186	185	184	183	182	181
180	179	178	177	176	175	174	173	172	171
170	169	168	167	166	165	164	163	162	161
160	159	158	157	156	155	154	153	152	151
150	149	148	147	146	145	144	143	142	141
140	139	138	137	136	135	134	133	132	131
130	129	128	127	126	125	124	123	122	121
120	119	118	117	116	115	114	113	112	111
110	109	108	107	106	105	104	103	102	101
100	99	98	97	96	95	94	93	92	91
90	89	88	87	86	85	84	83	82	81
80	79	78	77	76	75	74	73	72	71
70	69	68	67	66	65	64	63	62	61
60	59	58	57	56	55	54	53	52	51
50	49	48	47	46	45	44	43	42	41
40	39	38	37	36	35	34	33	32	31
30	29	28	27	26	25	24	23	22	21
20	19	18	17	16	15	14	13	12	11
10	9	8	7	6	5	4	3	2	1

Format 8,5 x 14



Tableaux de nombres (1 à 200 - du bas vers le haut)

200	199	198	197	196	195	194	193	192	191
190	189	188	187	186	185	184	183	182	181
180	179	178	177	176	175	174	173	172	171
170	169	168	167	166	165	164	163	162	161
160	159	158	157	156	155	154	153	152	151
150	149	148	147	146	145	144	143	142	141
140	139	138	137	136	135	134	133	132	131
130	129	128	127	126	125	124	123	122	121
120	119	118	117	116	115	114	113	112	111
110	109	108	107	106	105	104	103	102	101
100	99	98	97	96	95	94	93	92	91
90	89	88	87	86	85	84	83	82	81
80	79	78	77	76	75	74	73	72	71
70	69	68	67	66	65	64	63	62	61
60	59	58	57	56	55	54	53	52	51
50	49	48	47	46	45	44	43	42	41
40	39	38	37	36	35	34	33	32	31
30	29	28	27	26	25	24	23	22	21
20	19	18	17	16	15	14	13	12	11
10	9	8	7	6	5	4	3	2	1

Format 11 x 17

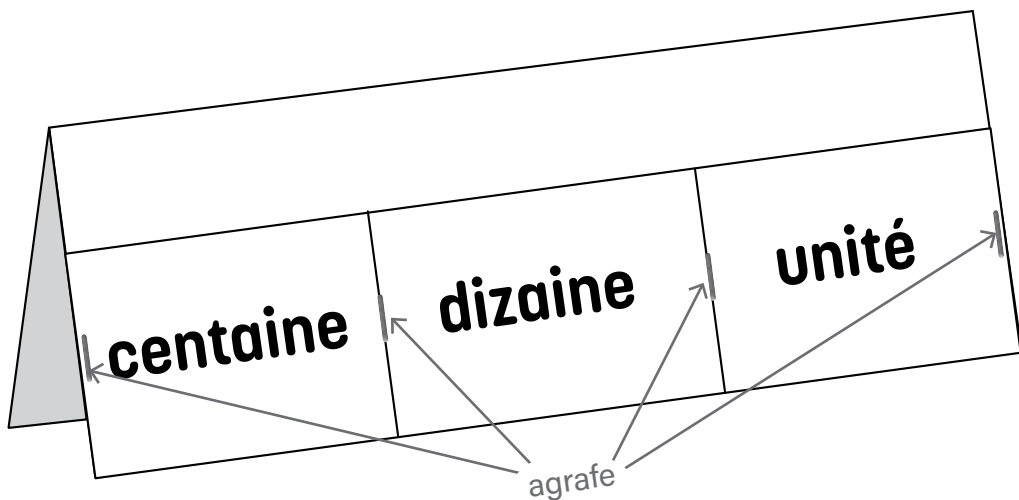
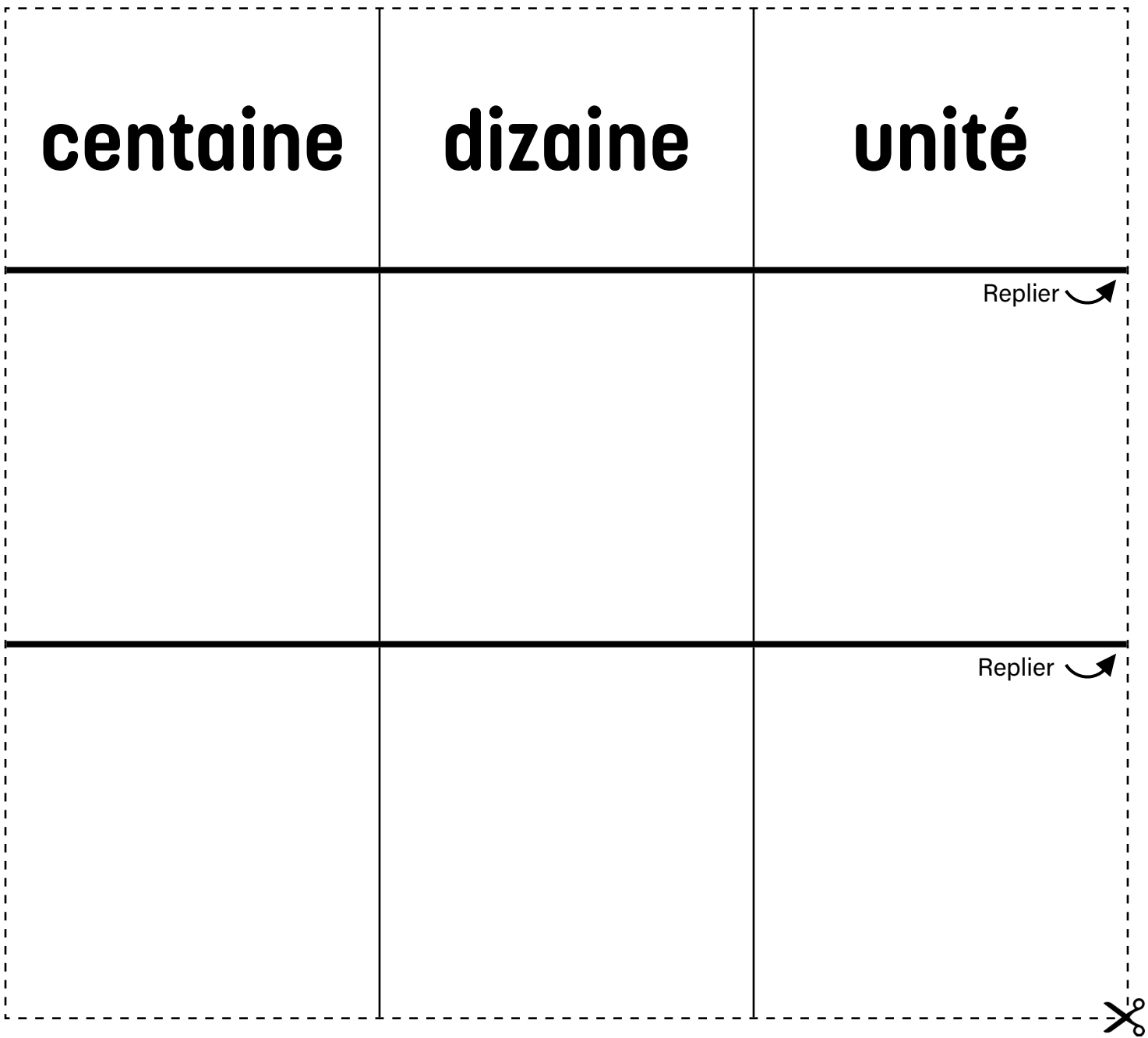

Pochettes des valeurs de position (millier)

millier	centaine	dizaine	unité

Replier

Replier

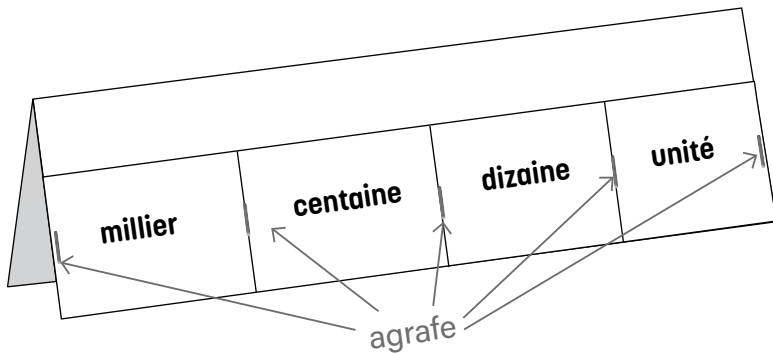

Pochettes des valeurs de position (dizaine de millier)



Ma boîte à outils en mathématiques

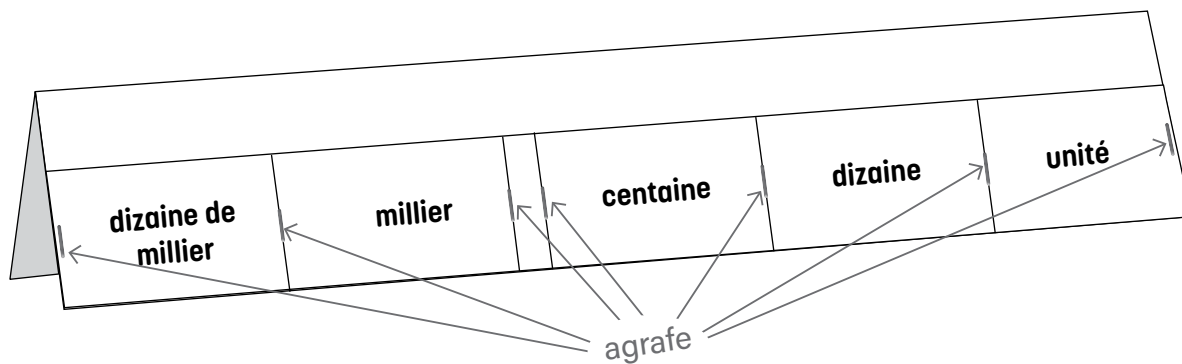

dizaine de millier	millier		centaine	dizaine	unité
					Replier ↷
					Replier ↷



Pochettes des valeurs de position (de la centaine au dixième)

centaine	dizaine	unité	,	dixième
				Replier 
				Replier 
				

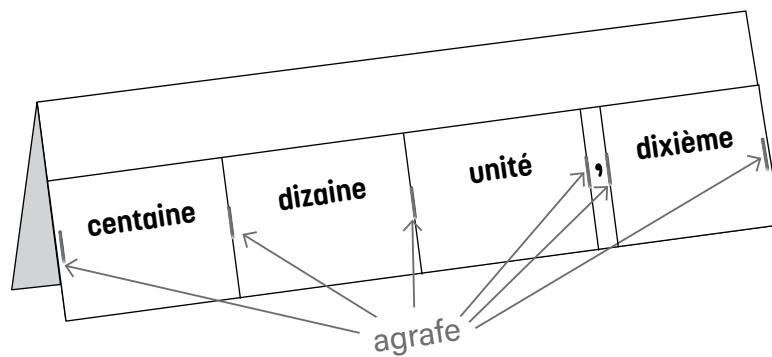

Pochettes des valeurs de position (de la centaine au centième)



centaine	dizaine	unité	,	dixième	centième
					Replier ↷
					Replier ↷

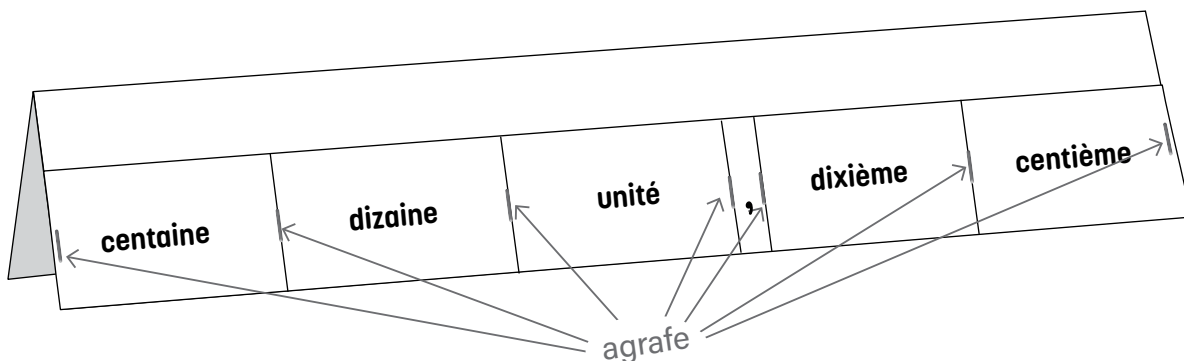

Cartes de chiffres (0-9)

0	1	2	3	4
5	<u>6</u>	7	8	<u>9</u>



Valeur de position - Tapis des valeurs de position (100)

Vides

centaine
100

dizaine
10

unité
1

Valeur de position - Tapis des valeurs de position (1000)
Vides

millier
1000



centaine
100

dizaine
10

unité
1

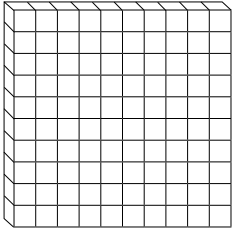
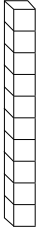

Valeur de position - Tapis des valeurs de position (100) avec cartes à 10 points vides Imagés

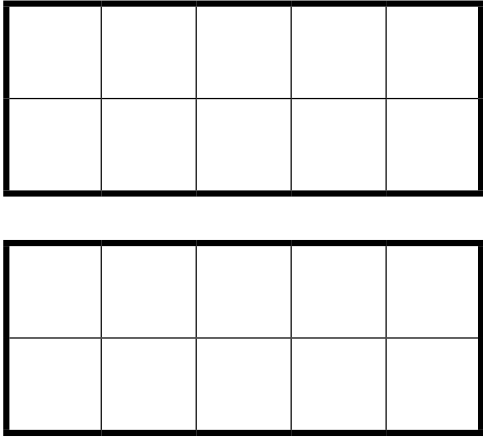
centaine 100 	dizaine 10 	unité 1 
		

Valeur de position - Tapis des valeurs de position (100) Imagés

centaine
100

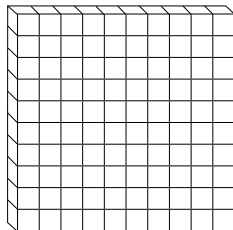

dizaine
10



unité
1



Valeur de position - Tapis des valeurs de position (1000) Imagés

millier
1000

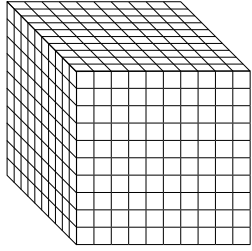

centaine
100

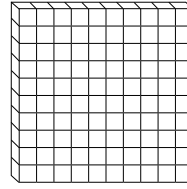

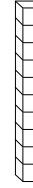

dizaine
10



unité
1



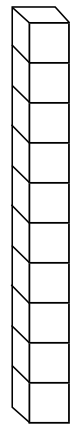

Valeur de position - Tapis des valeurs de position
Exemples

	unité	dixième
Représentation imagée		
Représentation symbolique	$\frac{10}{10} = 1$	$\frac{1}{10}$ ou $0,1$

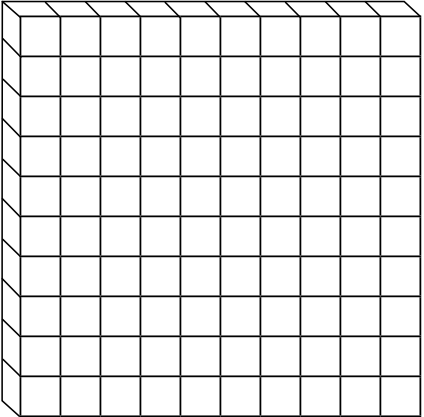
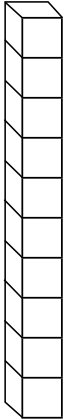

Valeur de position - Tapis des valeurs de position

Exemples

	unité	dixième	centième
Représentation imagée			
Représentation symbolique	$\frac{100}{100} = 1$	$\frac{10}{100} = \frac{1}{10}$ <p style="text-align: center;">ou</p> $0,1$	$\frac{1}{100} \text{ ou } 0,01$

Valeur de position - Tapis des valeurs de position

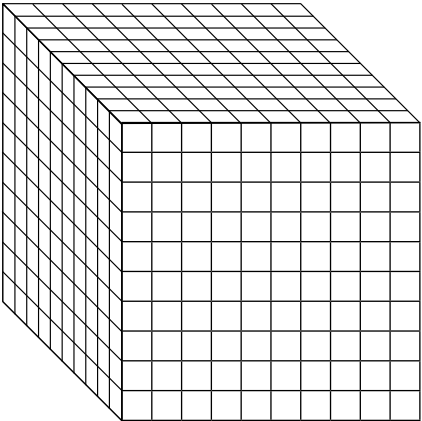
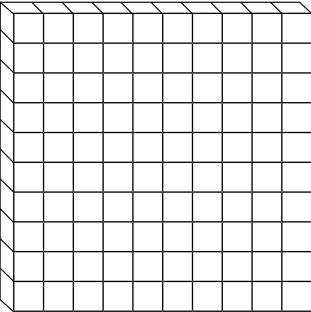
Exemples

	millier	centaine	dizaine	unité
Représentation imagée				
Représentation symbolique	1000	100	10	1



Valeur de position - Tentes de nombres jusqu'à 9999 (représentation symbolique)



Replier 

8 0 0 0



Replier 

7 0 0 0



Replier 

6 0 0 0



Replier 

5 0 0 0



Replier 

4 0 0 0



Replier 

3 0 0 0



Replier 

2 0 0 0



Replier 

1 0 0 0



Replier 

9 0 0 8 0 0



Replier 

7 0 0 6 0 0



Replier 

500 400



Replier 

300 200





Replier 

90 80 70



Replier 

60 50 40



Replier 

30 20 10



Replier 

9 8 7 6 5



Replier 

4 3 2 1 0



Liste partielle de matériel de manipulation et de modèles – Maternelle à la 4^e année

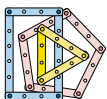
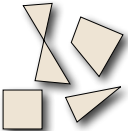
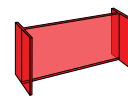
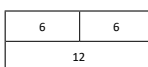
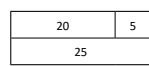
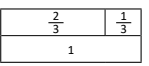

Maternelle	1 ^{re} année	2 ^e année	3 ^e année	4 ^e année
<ul style="list-style-type: none"> Bac à sable ou bac à eau Balance Bandes de nombres cachés Blocs logiques Blocs mosaïques Cartes à 5 et à 10 points Cubes emboîtables/cubes Unifix Dés Domino Jetons Objets à 3 dimensions Réglettes Cuisenaire Roulettes Tuiles de couleur Variété de collections 	<ul style="list-style-type: none"> Balance Bandes de nombres cachés Bâtonnets géométriques Blocs logiques Blocs mosaïques Dés, dominos Géoplans Objets à 3 dimensions Réglettes Cuisenaire Roulettes Tableau de 100 Tuiles de couleur Variété de collections 	<ul style="list-style-type: none"> Balance Bandes de nombres cachés Bâtonnets géométriques Blocs de base 10 Blocs logiques Blocs mosaïques Cubes emboîtables/cubes Unifix Dés, dominos Cartes de polygones réguliers et irréguliers Objets à trois dimensions Géoplans Réglettes Cuisenaire Roulettes Tuiles de couleur Variété de collections 	<ul style="list-style-type: none"> Balance Bandes de nombres cachés Bâtonnets géométriques Blocs de base dix Blocs logiques Blocs mosaïques Cartes de polygones réguliers et irréguliers Cubes emboîtables/cubes Unifix Dés, dominos Géoplans Objets à trois dimensions Pièces de monnaie et billets Règles Réglettes Cuisenaire Roulettes Tuiles de couleur Variété de collections 	
<ul style="list-style-type: none"> Calendrier Tableau « partie-partie-tout » Reconnaissance globale : carte de nombres (1 à 10), carte à points, constellation, carte de doigts, dé Variété de droites numériques (horizontale et verticale, ouverte et fermée) Dénombrement : corde à billes, abaque 	<ul style="list-style-type: none"> Base dix : carte à 10 points, corde à billes Calendrier Carte de nombres (1 à 100) Dénombrement et calcul : corde à billes, abaque, tableau de nombres, carte à points simple et double Reconnaissance globale : carte à points, constellation, dé, domino Tableau « partie-partie-tout »  <p>Variété de droites numériques (horizontale et verticale, ouverte et fermée)</p>	<ul style="list-style-type: none"> Base dix : carte à 10 points, tapis de valeur de position, tente de nombres jusqu'à 100 Calendrier Calcul : corde à billes, abaque, tableau de nombres, carte à points simple et double Carte de nombres (1 à 100) Tableau « partie-partie-tout »  <p>Variété de droites numériques (horizontale et verticale, ouverte et fermée)</p>	<ul style="list-style-type: none"> Base dix : carte à 10 points, tapis de valeur de position, tente de nombres jusqu'à 1000 Calcul : tableau de nombres, carte à points simple et double, variété de droites numériques (horizontale et verticale, ouverte et fermée) Carte de nombres (1 à 1000) Tableau de nombres Tableau partie-partie-tout 	<ul style="list-style-type: none"> Base dix : blocs de base dix, tapis de valeur de position, tentes de nombres jusqu'à 10 000 Calcul : arrangement rectangulaire, tableau de nombres, variété de droites numériques (horizontale et verticale, ouverte et fermée) Fraction : carte à 10 points, carte de fractions et modèles de région, de mesure (longueur et volume) ou d'ensemble Tableau de nombres Tableau « partie-partie-tout » 